

ISOTHERMAL MODELING STUDY OF CONCENTRATION FLUCTUATIONS IN MULTI-JET TURBULENT MIXING

AZEMAN MUSTAFA^{1*} & G. E. ANDREW²

Abstract. Water analogy flow visualisation and conductivity techniques with air bubbles and salt solution as tracers are relatively simple and cost-effective techniques for the qualitative and quantitative studies of turbulent fuel and air mixing and yet give very useful information about aerodynamic patterns and mixing characteristics of the system concerned. These techniques have been used to study the fuel placement effects on the flow aerodynamics and mixing characteristics of a series of multi-jet grid cone stabilised non-swirl flow. The experimental results showed that the degree of fuel and air mixing was largely governed by the internally-generated flow aerodynamics and the turbulent energy available. The methods of direct fuel injection had a major influence on the mixing uniformity only in the high turbulence jet interaction zone near the cone exit plane

Keywords: Fuel placement, turbulent mixing, non-swirl, flow aerodynamics, mixing uniformity

Abstrak. Teknik gambaran aliran analogi air dan keberaliran menggunakan gelembung udara dan larutan garam sebagai pengesan merupakan kaedah yang ringkas dan efektif (kos) untuk mengkaji secara kualitatif dan kuantitatif campuran gelora udara dan bahanapi. Teknik ini dapat memberi informasi yang sangat berguna mengenai corak aerodinamik dan ciri-ciri campuran bagi sesuatu sistem. Teknik ini telah digunakan untuk mengkaji pengaruh suntikan bahanapi ke atas aerodinamik aliran dan ciri-ciri campuran sistem tanpa pusar kon grid jet berbilang. Hasil ujikaji menunjukkan tahap pencampuran bahanapi dan udara sangat dipengaruhi oleh corak pembentukan dalam aerodinamik aliran dan penghasilan tenaga gelora. Teknik suntikan terus bahanapi memberi pengaruh yang besar ke atas keseragaman campuran di dalam zon interaksi jet bergelora tinggi berhampiran dengan satah keluar kon.

Kata kunci: Suntikan bahanapi, campuran gelora, tanpa pusar, aerodinamik aliran, keseragaman campuran

1.0 INTRODUCTION

Turbulence plays an important role in virtually all engineering problems involving fluid flow. Practically, the most important feature of turbulence is the strong mixing caused by the turbulent fluctuations. In combustion, turbulent mixing process is essential to the satisfactory combustion performance. Combustion in turbulent flows are mixing controlled, and chemical reactions can occur only when the reactants

¹ Department of Gas Engineering, Faculty of Chemical and Natural Resources Engineering, Universiti Teknologi Malaysia, 81310 Skudai, Johor, Malaysia.

² Department of Fuel and Energy, University of Leeds, Leeds, LS2 9JT, United Kingdom.

*Corresponding author: E-mail. azeman@fkkksa.utm.my

become molecularly mixed. The nature of the mixing process of fuel and air is very much dependent on the turbulent energy available, which is represented by the pressure energy dissipated in the flow at the burner entry ports [1]. The pressure energy is first converted to velocity stream, which decays in shear layers to turbulence. The rate of decay of the turbulence determines the degree of mixing in the combustor. The fluctuating turbulent motions contribute significantly to the transport of momentum, heat and mass and hence have a determining influence on the distribution of velocity, temperature and species concentrations over the flow field. The level and nature of concentration fluctuations due to turbulent mixing are particularly important, especially in environmentally sensitive combustion applications such as gas turbine situations, where the concentrations may be fluctuating in and out the flammability limits or between low and high pollutant producing regions.

The ideal method towards full understanding of the combustion characteristics of any particular combustor or burner geometry is to directly measure parameters related to the combustion process such as pressure, velocity, temperature and concentration species etc. Direct measurement of these parameters could provide detailed information of the internal structure of the combustion process but nevertheless it requires detailed experimental set-up which might be costly and quite time consuming. A number of workers [2-4] have adopted the isothermal investigation of turbulent flows as a first step means of full understanding the mixing present inside the combustor. The measurements from an isothermal flow system will not always be satisfactory for explaining the equivalent combusting flow system as the distribution of transport properties, density and viscosity is affected by the flow reacting [5]. Nevertheless extending the information obtained on isothermal studies for use in the development of combustion studies is important.

In the present work, the mixing characteristics of the non-swirling turbulent flows was experimentally investigated by means of different fuel injection modes simulated using a weak salt solution. The experiment was performed employing two well established isothermal modelling techniques, i.e. flow visualisation and measurements of scalar (concentration) mixing of three-dimensional turbulent mixing shear layers using water conductivity analogy with a weak salt solution as a tracer.

2.0 ISOTHERMAL STUDY OF TURBULENT MIXING CHARACTERISTICS

Fuel and air mixing in burners has been found to be similar for both isothermal flow and flows in combustion [6]. The aerodynamics of complex turbulent combustion situations such as gas turbine combustion chambers have been found to be essentially the same under combustion conditions as they are in isothermal models [7]. Thus, in a fully turbulent flow where the flow aerodynamics are strongly dependent on the Reynolds number, it is possible to investigate combustor aerodynamics simply by

examining the isothermal flow aerodynamics. The present isothermal study of turbulent mixing characteristics in the simulated combustion chambers were experimentally divided into two sections.

2.1 Qualitative Technique for Studying Aerodynamic Flow Patterns

An overall view of flow structure produced in a physical process can be observed with flow visualisation method in a range of applications, so as to provide useful information on the whole flow field [8,9]. This qualitative technique, known as flow visualisation technique, is based on the eye observation and the photography of the flow pattern in the model. The application of flow visualisation techniques using fluid flow analogy has been widely regarded as a cheap (compared with testing full size equipment), quick and reliable tool for the assessment of the aerodynamic design requirements. The flow visualisation technique provides a direct means of continuously observing detailed flow patterns by the use of transparent models with the aids of a high intensity light source. In this way, an extremely useful means of analysing the flow patterns in a complex fluid dynamic system is provided and the fulfilment of the aerodynamic design requirements can be assessed almost at a glance.

2.2 Quantitative Techniques for Studying Turbulent Scalar Mixing

Most study on scalar mixing in turbulent flows [10-13] has been accomplished mainly using temperature. Most turbulent temperature measurements have been for combustion situations where the temperature fluctuations are largely controlled by chemical reaction rather than pure mixing. Furthermore, it is impossible to distinguish turbulent temperature fluctuations arising from turbulent mixing and those from pure chemical reaction. Alternatively, the study of scalar mixing in turbulent flows can be quantitatively accomplished by probing the flow's local concentration of either a passive scalar or of a chemical product which is formed as a result of mixing and reaction between two different fluids. Concentration is a scalar and its measurement and interpretation are simpler than those of velocity and turbulence. Quantitative turbulent mixing and mean concentration are measured using water conductivity analogy with a weak salt solution as the tracer.

3.0 EXPERIMENTAL SET-UP

The non-swirl stabiliser employed in the present work, as shown in Figure 1, is a four-hole grid cone design which was originally designed by Al-Shaikhly [14] for his combustion tests. An isothermal mixing experimental set-up is schematically shown in Figure 2.

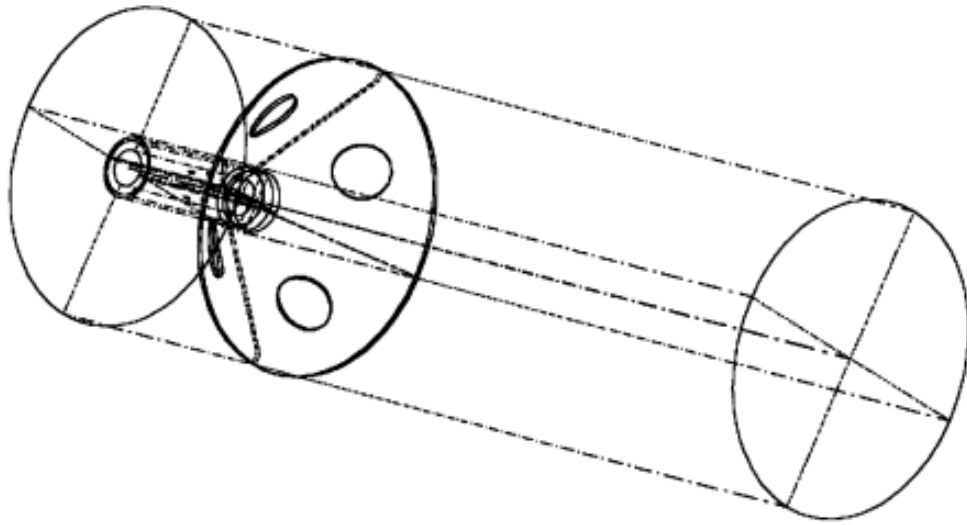

Figure 1 An isometric view of grid cone combustor

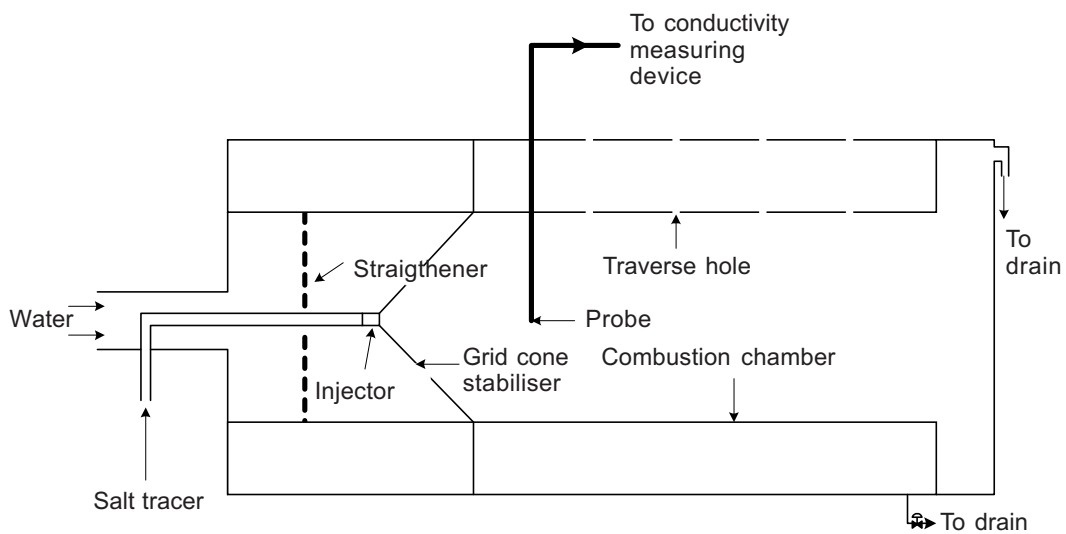

Figure 2 A schematic layout of the test rig

The present work investigated the influence of different modes of direct salt solution injection simulating a fuel on the turbulent mixing concentration characteristics of the non-swirl jet shear layer system. Two types of central injector, as shown in Figure 3, were tested. A simple 4 hole central injector was designed to enable a salt solution to be radially injected 45° to the horizontal axis, offset and inline injection with the hole centre. A central annular injector which was similar to the one used by Al-Shaikhly allowed a direct, radial and annular injection of a salt solution into the combustion

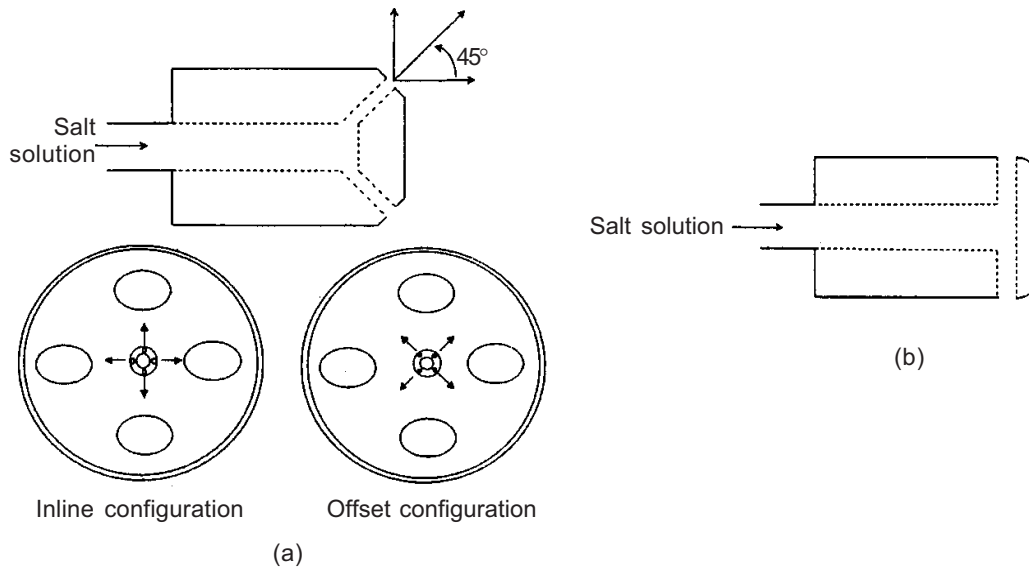

Figure 3 Injection system: (a) 4 hole central injector and (b) central annular injector type

chamber. The traverse measurements were carried out at selected radial positions between the wall and an injector was designed to enable a salt solution to be radially injected 45° to the horizontal axis, offset and inline injection with the hole centre. A central annular injector which was similar to the one used by Al-Shaikhly allowed a direct, radial and annular injection of a salt solution into the combustion chamber. The traverse measurements were carried out at selected radial positions between the wall and the combustor centreline at six axial locations, i.e. \bar{X}/D_s of 0.093, 0.379, 0.664, 0.950, 1.45, and 2.02.

A high frequency (50 kHz) AC voltage was applied to the probe with a load resistor in the circuit in parallel with a transformer. The transformer was used to detect the voltage of the amplitude modulated supply signal. It gave a high common mode rejection that would not be as simple to obtain with a differential amplifier. The detected voltage was amplified and filtered of electrical noise and displayed on an oscilloscope.

The primarily determinant of the probe resolution is the size of the small electrode. The smaller the electrode, the larger the current density at the electrode and thus the greater the proportion of voltage dropped in the vicinity of the probe. The probe calibration was carried out by initially making up 1000 ml of distilled water with 4.0 gram of common salt (NaCl) in a 1000 ml flask. The probe was dipped in a 100 ml of prepared salt solution and the voltage was recorded on the D.C average meter. The solution was then diluted with 100 ml distilled in replacement of 100 ml of salt solution which was taken out earlier. The procedure was repeated until there was no further substantial difference in conductivity reading.

4.0 FLOW PATTERNS VISUALISATION

The aerodynamic flow patterns were observed by using small air bubbles as tracers, accomplished by controlling the water pump valve, and a two-dimensional light sheet illumination. Figure 4 shows a photographic reproduction of the flow patterns for a four-hole grid cone stabiliser. The observed aerodynamics flow patterns showed the water jets had deflected on passing through the conical stabiliser and impinged on each other on the centre line. As a result, two opposing flows were created, one directed backwards into the cone forming inner recirculation region while the other directed axially downstream forming outer recirculation region near the wall. This is consistent with the outcome of the two-dimensional water modelling flow visualisation [14]. The WRZ was extended to about 200 mm downstream of the cone exit compared with 180 mm obtained from the experimental measurements. It should be noted that the wall recirculation length is only an approximate value as it is difficult to measure accurately from the developed film negative, but it still gives a reasonable agreement with the static pressure profile obtained from the experimental measurements.

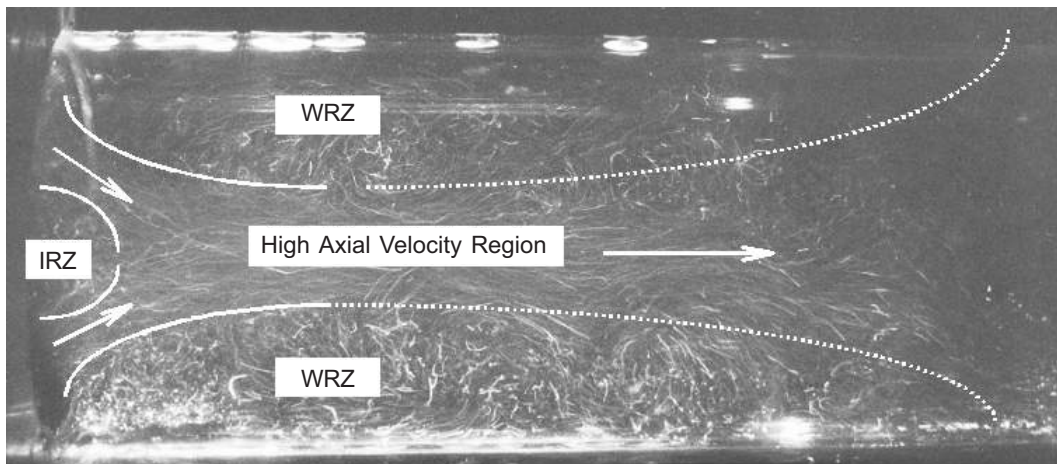

Figure 4 Side view of jet interaction

5.0 MEAN CONCENTRATION AND FLUCTUATION MIXING RESULTS

In the present work, the dilution mechanism of salt solution by water is considered to be the same as the mixing process. The mixing results were expressed as a deviation from the mean concentration. A term known as the mixed-mean concentration ratio was introduced to express variation in conductivity in terms of mixing parameter. The mixed-mean concentration ratio is simply a ratio of the concentration of salt solution at any point to the mean concentration of fully mixed solution in the model. In the present work, the water and salt solution were considered to be fully mixed at an X/D of 2.02, where variation in conductivity was found to be very slight. In the well mixed region,

the mixed-mean concentration ratio was one, elsewhere values greater than one were fuel rich and less than one were fuel lean. The water and salt solution flow rates were fixed at 80 l/min and 2.5 l/min, respectively, thus giving an air/fuel ratio of 32/1.

Figures 5-8 show radial variations in the mixed-mean concentration ratio and the turbulent fluctuations for three fuel injection modes. These figures clearly show that the methods of fuel injection had a major effect on the mixing in the jet interaction region near the stabiliser exit, as indicated by large concentration and turbulent mixing gradients in the jet shear layer region. Comparison of the mixing results shows that the inline fuel injection produced the radial mixing profiles of the least deviation from the mean and also of the least difference between the inline and offset measurements.

The inline mixing profiles at $X/D=0.093$ in Figure 5 shows a rich/lean/rich system for the central annular fuel injection and the inline fuel injection and a lean/rich system for the offset fuel injection. In the central region ($r/R \leq 0.25$), the inline fuel injection produced the richest mixing on the combustor centreline but the fuel was rapidly mixed as it radially moved into the shear layer mixing region. The richer central region of the inline fuel injection as compared with that of the central annular injection was expected as all fuel was directly injected into the shear layer. The reason for the leanest central region of the offset fuel injection was evident; the fuel was not injected into the jet shear layer. In the outer region, all three fuel injection methods produced the mixing profiles which were radially richer towards the wall. This was expected for the central annular and inline injection modes. However, for the offset injection this was not expected and the rich mixing near the wall was probably due to the fuel injected between the shear layers impinging on the wall and subsequently swept into the region inline with the jet centreline. Further downstream of stabiliser exit, the mixing profiles of the three fuel injection modes show a similar trend of a lean central region and a slightly rich near wall region. At $X/D=0.379$ and $X/D=0.664$, the offset fuel injection still produced a distinct lean/rich profile compared with the annular and inline injection modes. In the outer region, the mixing was completed by $X/D=0.950$ but the lean central region was slowly mixed with the axial outer recirculation zone and became complete by $X/D=1.45$. The mixing intensity profiles in Figure 6 shows a similar trend of high concentration fluctuations in the interacting shear layers and further away from the jet interaction zone the fluctuations were at minimum values.

The offset mixing profiles for three fuel injection modes are shown in Figure 7. In comparison with the inline profiles in Figure 5, the offset traverses show the most non-uniform radial mixing profile and the largest concentration ratio difference between the three fuel injection profiles. At an X/D of 0.093, the mixing was above the mean for all investigated fuel injection modes except on the centreline, where the mixing was slightly in the lean region for the offset injection mode. With the annular injection mode, the central region was around 20-25% rich and radially increased to reach the peak richness of 60% in the wall region. With the inline injection mode, the mixing was unexpectedly 10-20% rich even though the fuel was not directly injected in the offset line. With the offset injection mode, the radial mixing was 90% of the mean on

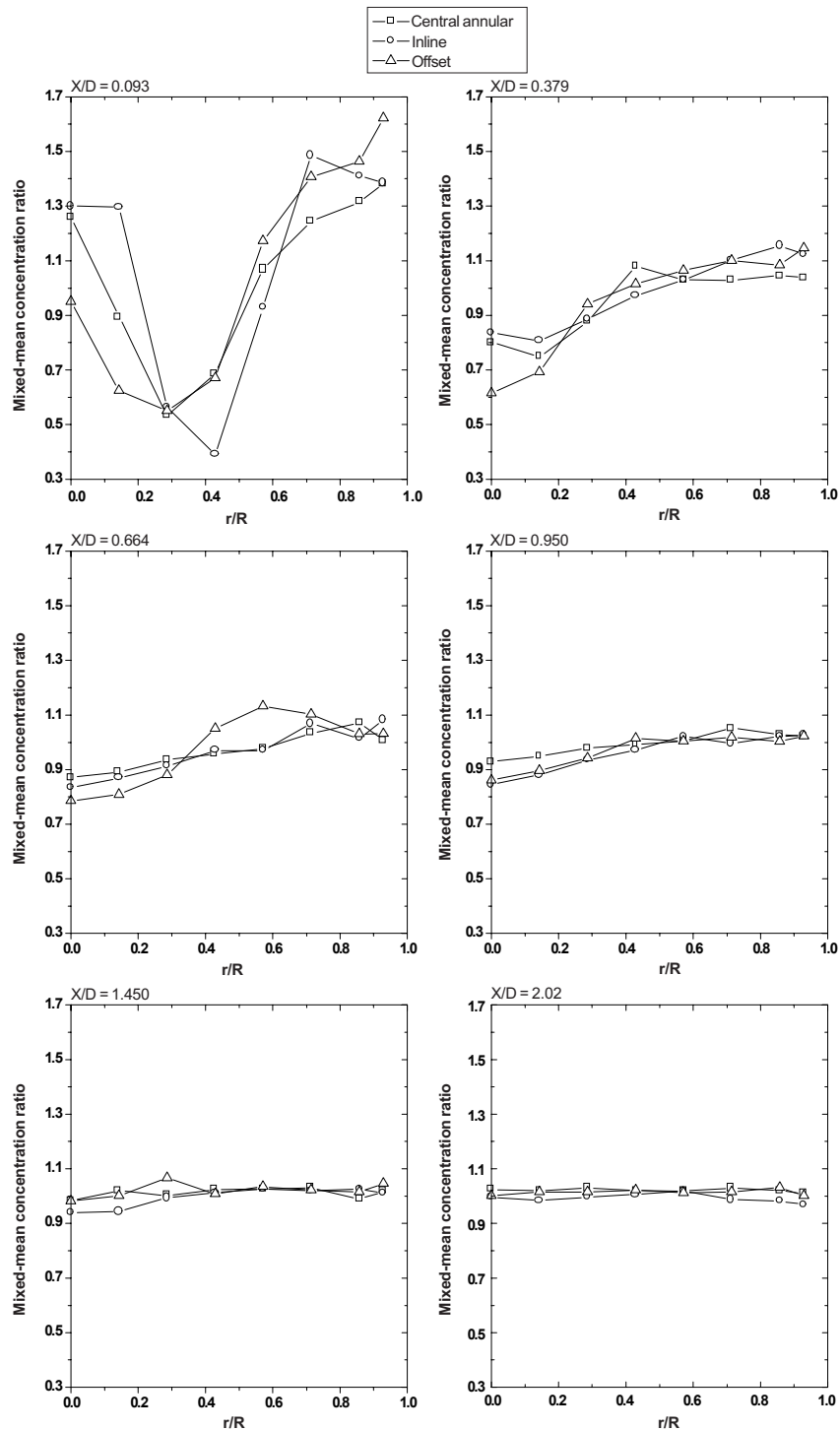

Figure 5 Effect of injection modes on mixed-mean concentration ratio mixing profiles (data taken at points inline with the hole centre)

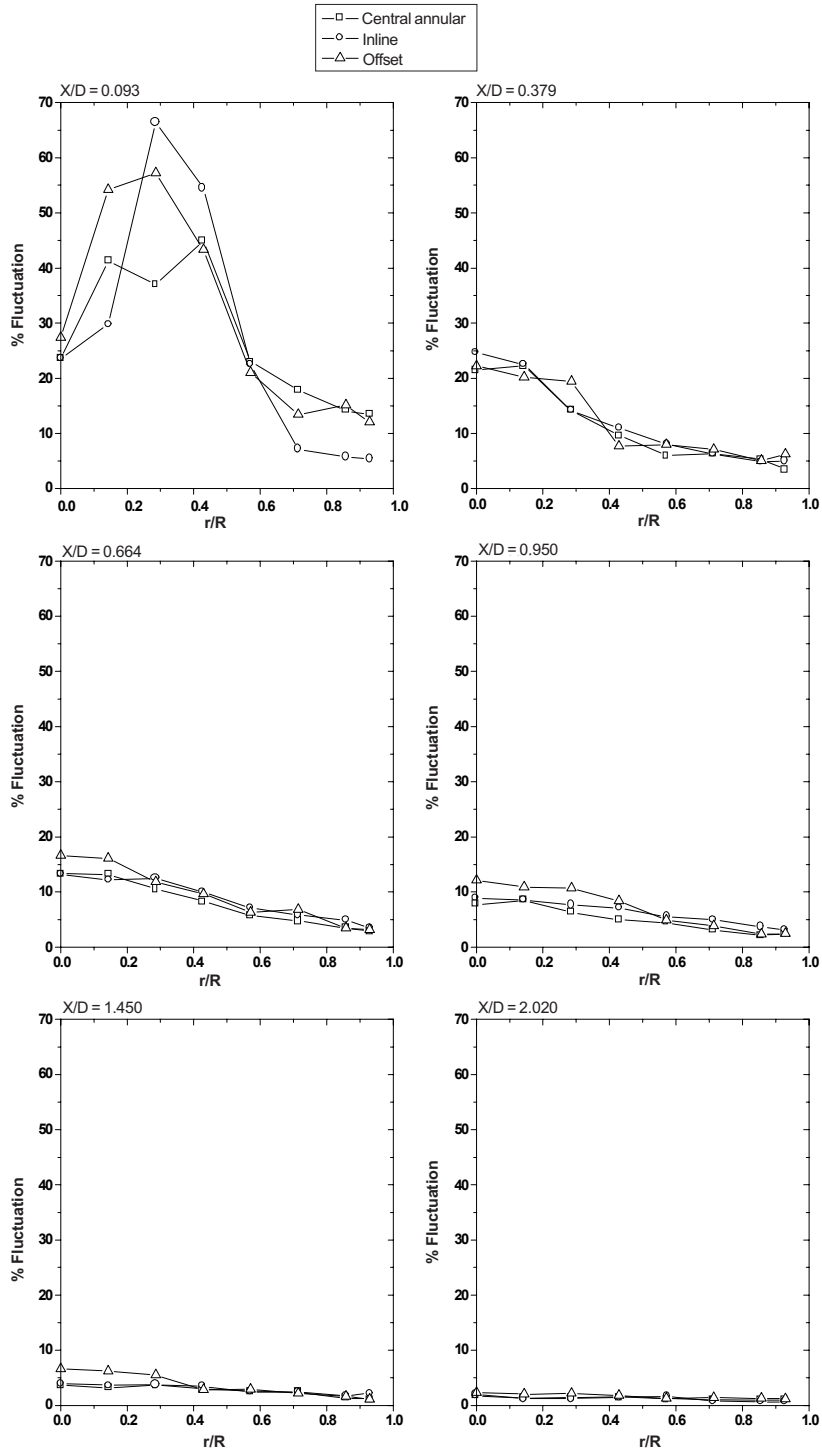

Figure 6 Effect of injection modes on turbulent fluctuation profiles (data taken at points inline with the hole centre)

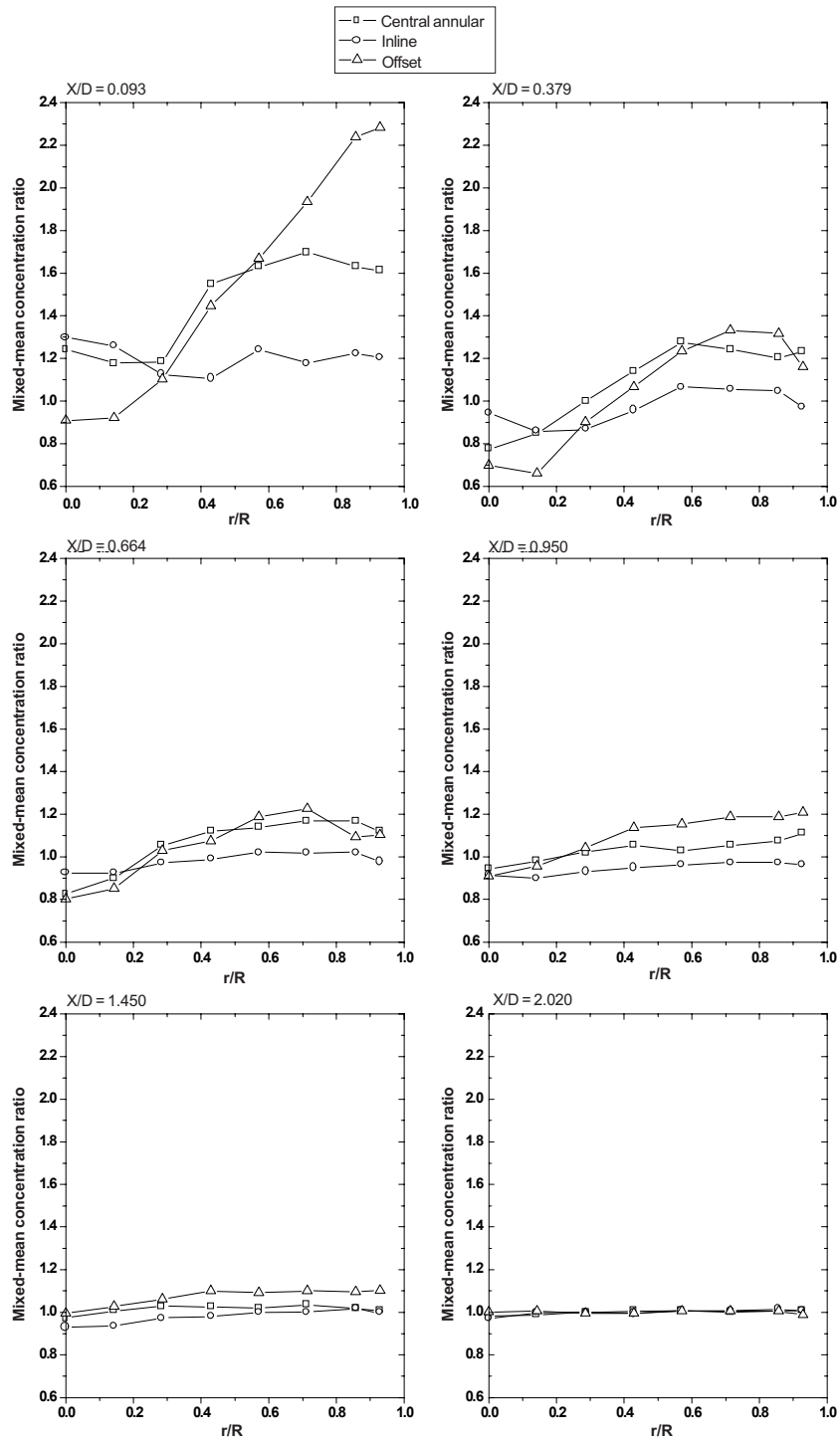

Figure 7 Effect of injection modes on mixed-mean concentration ratio mixing profiles (data taken at points offset the hole centre)

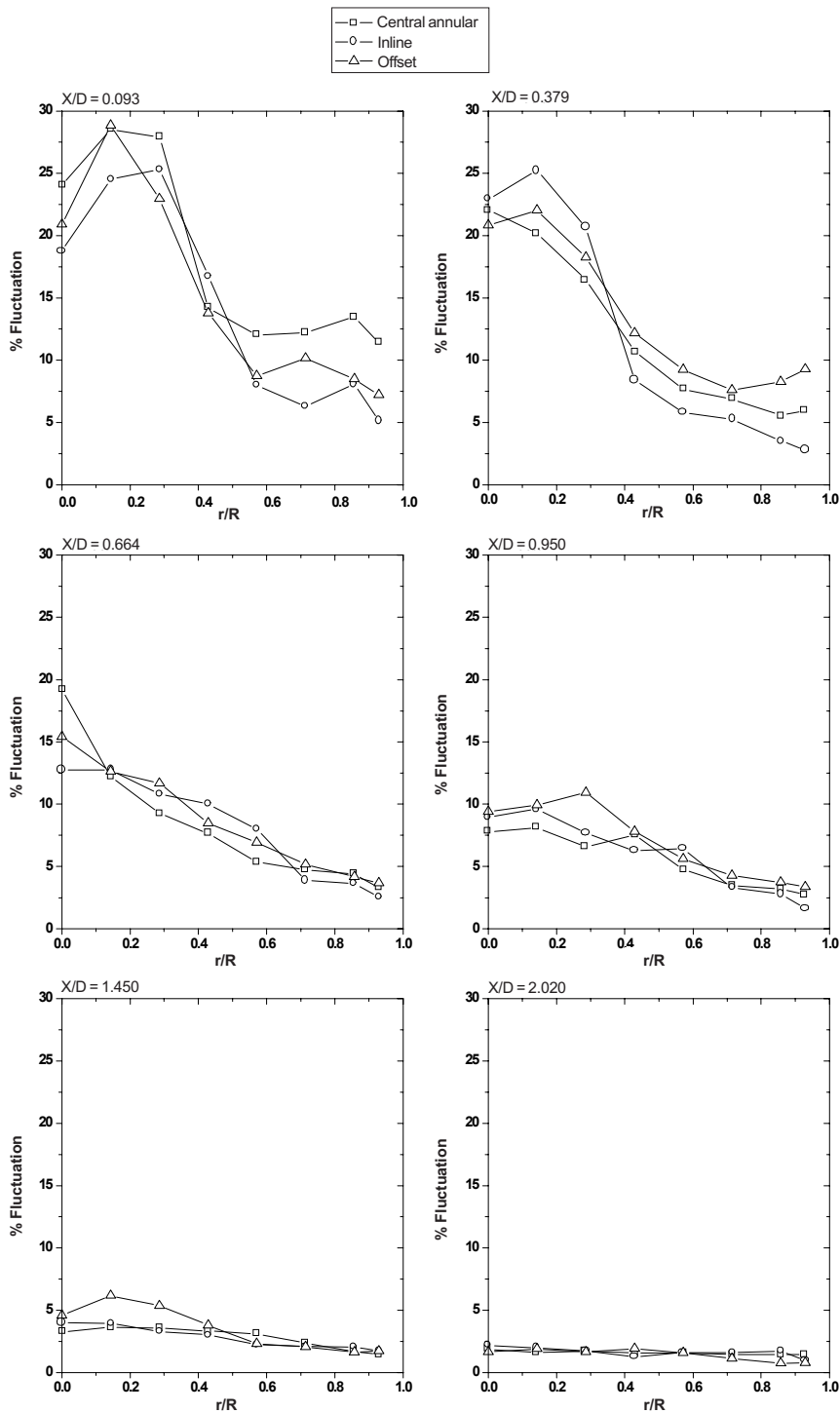

Figure 8 Effect of injection modes on turbulent fluctuation profiles (data taken at points offset the hole centre)

the centreline and became radially richer, reaching the peak richness of 2.25 times the mean near the wall. Thus, the offset traverses of the offset fuel injection exhibited a strong lean/rich mixing profile.

At an X/D of 0.379, the mixing results of all injection modes showed a similar trend of lean central region and of steady increase in the local fuel concentrations, reaching the maximum values near the wall. With the annular injection, a lean/rich profile was still noticeable; 80% mixed on the centreline and radially increased to reach the peak richness of 20% near the wall. The offset injection produced a stronger lean/rich profile than the annular injection; the mixing ranged from 80% of the mean in the central region to 30% rich near the wall. The inline injection was first to achieve complete mixing at $X/D=0.664$, followed by the annular injection at $X/D=0.95$ and the offset injection at $X/D=1.45$. The offset turbulent fluctuation profiles in Figure 8 again show the peak fluctuations were at the jet interaction zone just downstream of the stabiliser exit where most mixing took place. Comparison of the offset and inline turbulent intensity profiles in Figures 6 and 8 shows that the peak fluctuations of the inline plane were between 40-70% with the inline injection mode showing the highest peak value compared with the peak offset fluctuations of 25-28%. This is also in agreement with the mixing results in Figures 5 and 7 which show more uniform inline mixing profiles.

6.0 CONCLUSIONS

- (1) Modes of fuel injection had a major effect on the mixing in the immediate jet interaction zone downstream of the stabiliser exit. Further away from this mixed region, the effect was less significant.
- (2) The inline fuel injection was shown to give rapid mixing as the fuel was injected into the high turbulence region of the jet shear layers. This consequently produced radial mixing profiles of the least deviation from the mean and hence the most uniform mixing.
- (3) The offset fuel injection was shown to produce a strong aerodynamic lean/rich profile particularly in the jet interaction region downstream of the stabiliser exit. Hence, the mixing was the worst among the three fuel injection methods investigated. The mixing characteristics of the annular central fuel injection were a compromise between the inline and the offset fuel injection modes.
- (4) High concentration fluctuations were found in the jet interaction zone where the turbulent mixing was at its maximum intensity. This corresponded to a region of rapid fuel and air mixing. In the mixed region further away from the jet interaction zone, the concentration fluctuations became increasingly insignificant.

ACKNOWLEDGEMENTS

The authors would like to thank Universiti Teknologi Malaysia for the financial support and University of Leeds for providing the facilities to carry out this research work.

REFERENCES

- [1] Andrews, G. E., M. M. Abdul Aziz, U. S. Abdul Hussain, N. A. Al-Dabbagh, N. A. Ahmad, A. F. Al-Shaikly, H. S. Al-Kabie, M. Kowkabi, and A. R. Shahbadi. 1989. High Intensity Burners with Low NO_x Emissions. British Flame Days 1988. Furnace Combustion Research and its Applications. The Institute of Energy.
- [2] Palma, J. M. 1989. Mixing in Non-reacting Gas Turbine Combustor Flows. Ph.D. Thesis. University of London.
- [3] McGuirk, J. J., and J. M. L. M. Palma. 1995. Experimental Investigation of the Flow Inside a Water Model of a Gas Turbine Combustor: Part 2 - Higher Order Moments and Flow Visualisation. *Transaction of the AMSE - Journal of Fluid Engineering*. 117.
- [4] McGuirk, J. J., and J. M. L. M. Palma. 1995. Experimental Investigation of the Flow Inside a Water Model of a Gas Turbine Combustor: Part 1 - Mean and Turbulent Flowfield. *Transaction of the AMSE - Journal of Fluid Engineering*. 117.
- [5] Syred, N., and M. Beer. 1974. Combustion in Swirling Flows: A Review. *Combustion and Flame*. 23: 143-201.
- [6] Syred, N., and M. Beer. 1971. Flame Stabilisation in Recirculation Zones of Jets with Swirl. The Thirteenth Symposium (Int.) on Combustion. The Combustion Institute. Pittsburgh. 617-624.
- [7] Clarke, A. E., A. J. Gerrard, and L. A. Holliday. 1962. Some Experience in Gas Turbine Combustion Chamber Practice Using Water Flow Visualisation Techniques. The Ninth Int. Symposium on Combustion. The Combustion Institute. Pittsburgh: 875-891.
- [8] Merzkirch, W. 1974. *Flow Visualisation*. New York: Academic Press.
- [9] Vest, C. M. 1979. *Holographic Interferometry*. New York: John Wiley.
- [10] Ahmed, S. A., R. S. Boray, and A. S. Najed. 1989. An Experimental Investigation of Isothermal Swirling Flow in a Model of a Dump Combustor. *ISABE Paper*. 89-7072: 689-702.
- [11] Sturgess, G. J., S. P. Heneghan, M. D. Vangsness, D. R. Ballal, and A. L. Lesmerises. 1991. Isothermal Flow Fields in a Research Combustor. *ASME Paper*. 91-GT-37.
- [12] Yanagi, T., and Y. Mimura. 1981. Velocity Temperature Correlations in Premixed Flames. The Eighteenth Int. Symposium on Combustion. The Combustion Institute. Pittsburgh. 1031-1039.
- [13] Abdalla, A. Y., D. Bradley, S. B. Chin, and C. Lan. 1982. Temperature Fluctuations in a Jet Stirred Reactor. The Eighteenth Int. Symposium on Combustion. The Combustion Institute. Pittsburgh. 459-502.
- [14] Al-Shaikhly, A. F. A. 1989. Jet Shear Layer, Lean Primary Zones for Low Emissions Gas Turbine Combustion. Ph.D. Thesis. Dept. of Fuel and Energy, University of Leeds.