

# Fuzzy Logic Control of Centralized Chilled Water System

Noor Asyikin Sulaiman<sup>a</sup>, Mohd Fauzi Othman<sup>a\*</sup>, Hayati Abdullah<sup>b</sup>

<sup>a</sup>Centre of Artificial Intelligent and Robotic (CAIRO), Universiti Teknologi Malaysia, Kuala Lumpur, Malaysia

<sup>b</sup>Centre of Electrical Energy System (CEES), Universiti Teknologi Malaysia, 81310 UTM Johor Bahru, Johor, Malaysia

\*Corresponding author: mdfauzi@utm.my

## Article history

Received :15 June 2014

Received in revised form :

15 September 2014

Accepted :15 October 2014

## Graphical abstract

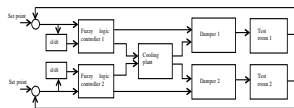

## Abstract

Fuzzy logic controller has been proven to control nonlinear process system and HVAC is a type of nonlinear process systems. This paper studies the performance of fuzzy logic controller with three and five term membership function in centralized chilled water system. Three different cases are simulated and analyzed for both type of controllers. Results show that the performances between both controllers are almost similar with no significant difference. It is also encountered that in certain cases, 3-mf fuzzy logic controller outperformed 5-mf fuzzy logic controller.

**Keywords:** Membership functions; fuzzy logic controller; HVAC

© 2015 Penerbit UTM Press. All rights reserved.

## 1.0 INTRODUCTION

Fuzzy logic controllers are capable of controlling nonlinear process model significantly better than linear controllers [1]. Castro, Castillo and Melin [2] implemented interval type-2 fuzzy controller in truck backer-upper system and compared the results with type-1 fuzzy controller. It shows that both controllers are able to control the car trajectories with similar performance. Birkin and Garibaldi [3] compared the performance of type-1 and type-2 fuzzy logic controllers with PID controller in micro-robot. Results show that both type-1 and type-2 fuzzy controller have similar performance and can perform better than PID controller.

However, studies show that not many fuzzy logic based controllers are used in the application of HVAC control [4]. Becker, Oestreich, Hasse and Litz [5] applied fuzzy controller in the refrigeration system to control temperature and relative humidity. Results show that fuzzy controller has better performance when induced with disturbances and change of set point compared to on-off controller. Adaptive fuzzy controller was also successfully implemented in HVAC system to control indoor thermal comfort as in [6]. The controller shows its capability to fast control the indoor comfort conditions even though the outdoor condition varies. Aprea, Mastrullo and Renno [7] have successfully developed fuzzy controller in choosing appropriate compressor speed in refrigeration plant. Soyguder, Karakose and Alli [8] designed self-tuning PID-type fuzzy adaptive control for HVAC system which has two different zones.

Most of the previous papers that implemented fuzzy based controller used five-term membership functions or higher as in [3, 5-8]. It is because the higher number of membership functions means the higher rules which results in better accuracy as it reduces the root mean square error [9]. Only a handful of papers

available used 3 membership functions in the fuzzy controller as in [2, 10].

In this paper, the performance of fuzzy logic controller with three and five-term membership functions are analyzed and compared. The controllers are implemented at centralized chilled water system, which has 2 zones with the same properties and dimensions. The performance of both controllers is investigated on different cases. Results show that both controllers were able to reach the set point.

A chilled water system model was used to provide the process for the controllers as explained in Section 2. Section 3 describes the method used in this research and explains the process of designing the fuzzy logic controllers and the setting of the simulation. Section 4 presents the results and discussion of them. Lastly Section 5 delivers the conclusion of the findings.

## 2.0 MODELLING OF CHILLED WATER SYSTEM

The system used in this paper was modeled as presented in [11-13]. It consists of two test rooms with the same properties and dimensions, cooling coil, mixing air chamber and chiller. The block diagram of the system is shown in Figure 1. It was assumed that the chiller compressor was a constant speed type and the opening of damper position was from 5° to 90° and each of the room had an individual damper for control purposes.

The heat rejected by the test room was assumed to be equivalent to the amount of cooling load distributed into it, internal heat gain and heat from the ambient is as follow,

## Nomenclature

$M$	heat mass capacitance
$C_v$	specific heat at constant volume
$\rho$	air density
$C_p$	specific heat at constant pressure
$Q$	volumetric flow rate
$T$	temperature
$U$	overall heat transfer coefficient
$A$	Area
$h_{fg}$	latent heat of water
$w$	humidity ratio

## subscripts;

$cc$	cooling coil
$a$	air
$tr$	test room
$s$	supply air
$amb$	ambient air
$mixed$	mixed air
$w$	water
$chwr$	chilled water return
$chws$	chilled water supply
$evap$	evaporator

$$M_{tri} C_v \frac{dT_{tri}}{dt} = Q_a \rho_a C_{pa} (T_s - T_{tri}) + \dot{Q}_{int} + U_{tri} A_{tri} (T_{amb} - T_{tri}) \quad (1)$$

where  $i = 1, 2$ .

The cooling coil, where heat exchange process happened is modeled as follow,

$$M_{cc} C_v \frac{dT_s}{dt} = \rho_a C_{pa} Q_{mixed} (T_{mixed} - T_s) + U_{cc} A_{cc} (T_{amb} - (T_s + T_{mixed})) + Q_w \rho_w C_{pw} (T_{chws} - T_{chwr}) + (h_{fg} - C_{pa}) \rho_a Q_{mixed} (w_{mixed} - w_s) \quad (2)$$

The mixed air is returned air from both test rooms and the mixed air temperature,  $T_{mixed}$  and its air flow rate,  $Q_{mixed}$  are given as follows,

$$T_{mixed} = \frac{(Q_{a1} + Q_{a2}) \left( \frac{T_{tr1} + T_{tr2}}{2} \right) + Q_{amb} T_{amb}}{Q_{a1} + Q_{a2} + Q_{amb}} \quad (3)$$

$$Q_{mixed} = Q_{a1} + Q_{a2} \quad (4)$$

The chiller tank temperature is expressed by

$$M_{evap} C_v \frac{dT_{chwr}}{dt} = U_{cc} A_{cc} (T_{amb} - T_{chwr}) + \dot{Q} + Q_w \rho_w C_{pw} (T_{chws} - T_{chwr}) \quad (5)$$

### 3.0 METHODOLOGY

Two types of fuzzy logic controllers were used in the simulation which was three-term fuzzy logic controller and five-term fuzzy logic controller. The objective of this controller was to set the room temperature according to the reference temperature value. In order to obtain the desired temperature value, the controllers control the amount of supply air flow rate that entered the test room and the amount of chilled water flow rates. The amount of air flow rate can be varied by adjusting damper position between 5° and 90° [14]. For control purposes, each of the room had an individual damper. Meanwhile, the chilled water flow rate was adjusted from 70% to 110% of the design flow rate [15].

#### 3.1 Fuzzy Logic Controllers

For each type of controller, two controllers were used in the system as portrayed in Figure 1. The control inputs to the controllers were temperature error,  $e$ , and the rate of change of temperature error,  $\Delta e$ . Meanwhile, the outputs were the damper position,  $u_1$ , and chilled water flow rate,  $u_2$ .

##### 3.1.1 Five Membership Function Fuzzy Logic Controller

The rules for this controller are shown in Tables 1 and 2. Table 1 represents the fuzzy rules of damper while Table 2 describes the rules of chilled water flow rate. Both inputs membership functions used were negative big–NB, negative small–NS, zero–Z, positive small–PS, and positive big–PB; and the shape of these membership functions are a combination of triangle and trapezoid. As for the damper position,  $u_1$ , the membership functions used were very big–VB, big–B, medium–M, small–S, very small–VS. Meanwhile,  $u_2$  was identified by very fast–VF, fast–F, medium–M, slow–S and very slow–VS. The shape of each output membership function is a trapezoid.

##### 3.1.2 Three Membership Function Fuzzy Logic Controller

The inputs and outputs membership functions of 5-term fuzzy controller were modified and reduced from five to three. The inputs used in this controller were negative–N, zero–Z and positive–P. The Z membership function was created by combining the terms of Z, NS and PS in 5-term fuzzy controller. N was formed from NB and P from PB. The same method was done to generate the membership function of both outputs. As for the damper position,  $u_1$ , the membership functions used were big–B, medium–M and small–S, while, the  $u_2$  were identified by fast–F, medium–M and slow–S. The type of input and output membership functions was similar to 5-term fuzzy controller. The rules are shown in Tables 3 and 4.

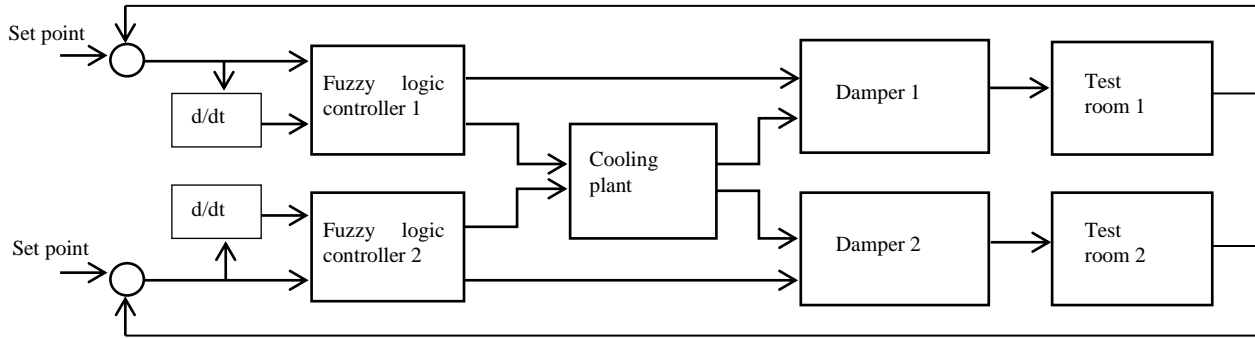

Figure 1 The block diagram of the system

Table 1 Rules for  $u_1$

$\Delta e$	NB	NS	Z	PS	PB
e					
NB	M	M	B	VB	VB
NS	M	M	M	B	VB
Z	VS	S	M	M	B
PS	VS	S	S	M	M
PB	VS	VS	S	S	M

Table 2 Rules for  $u_2$

$\Delta e$	NB	NS	Z	PS	PB
e					
NB	M	M	F	VF	VF
NS	S	M	M	F	VF
Z	VS	S	M	M	M
PS	VS	VS	S	M	M
PB	VS	VS	VS	S	M

Table 3 Rules for  $u_1$

$\Delta e$	N	Z	P
e			
N	M	B	B
Z	S	M	B
P	S	S	M

Table 4 Rules for  $u_2$

$\Delta e$	N	Z	P
e			
N	M	F	F
Z	S	M	M
P	S	S	M

3.2 Simulation

Simulations were done using MATLAB/SIMULINK on both controllers for  $t = 300s$ . Some parameters were set constant throughout the simulations as in [10, 11] such as: ambient temperature  $T_{amb}$  (°C), heat mass capacitance of test room  $M_{tr}$  (kg), specific heat at constant volume  $C_v$  (J/kg K), overall heat transfer coefficient  $U$  (W/m<sup>2</sup> K), air density  $\rho$  (kg/m<sup>3</sup>), each component area  $A$  (m<sup>2</sup>), specific heat at constant pressure  $C_p$  (J/kg K), latent heat of water  $h_{fg}$  (J/kg), temperature of supply chilled

water system  $T_{chws}$  (°C) and humidity ratio  $w$ . The reference set point temperature was set according to the Malaysian Standard (MS 1525:2007), which is 24°C.

There are three different cases of simulation discussed in this paper. Case 1 represents normal operation of both dampers. Case 2 interpreted as damper 1 operated normally but damper 2 was stuck at about 33%. Lastly, Case 3 represents both dampers stuck at about 50%. The details of the initial conditions of supply air flow rate  $Q_{a1}$  and  $Q_{a2}$  that entered each room for each case are presented in Table 5.

4.0 RESULTS AND DISCUSSIONS

In Case 1, it was assumed that both dampers, 1 and 2, operated in normal condition where they are free to swing from 5° to 90° during simulation, depending on the output of the controller. Figures 2 and 3 portray room temperature variation for case 1 of 3-mf and 5-mf fuzzy logic controller respectively. From the graph, it shows that 3-mf fuzzy logic controller was able to cool down both test room from 34°C to 23.4°C, while 5-mf fuzzy logic controller at 23.9°C. A comparison between both performances is depicted in Figure 4. It can be observed that the 5-term fuzzy controller had slightly better performance compared to 3-term fuzzy controller when it settled at 23.9°C, which was closer to the desired temperature setting.

Meanwhile, for Case 2, it was assumed that damper 2 was stuck at about 33% from the max opening of the damper, while damper 1 functioned as normal. It means that damper 2 could only swing up to 60°, thus lowering the maximum supplied air flow rate that entered test room 2. Observations from Figure 5 showed that there was only a slight lower temperature in test room 1 as compared to test room 2 during transient time. Nonetheless, the temperature in both test rooms was almost similar throughout the steady state time. As a result, it showed no significant difference between both test rooms' temperature variations during cooling down process using 3-mf fuzzy controller.

However, for 5-mf fuzzy logic controller, as portrayed in Figure 6, showed that the test rooms' temperature variation between test room 1 and test room 2 was quite big during the cooling down process. The result was expected since damper 2 was stuck at around 33% while damper 1 functioned normally. During this scenario, test room 2 received lower air flow rate compared to test room 1. Thus, the cooling process became slower in test room 2 and caused the temperature of test room 1 to become lower than the temperature of room 2. Nevertheless, the 5-membership function controller was able to control test rooms 1 and 2 to 23.6°C and 24°C respectively.

For case 3, a simulated condition when both dampers were stuck at 50% from the maximum position was examined. It means that supplied air flow rate was reduced to half of its maximum amount. Figure 7 and Figure 9 portray rooms' temperature variation for case 3 of 3-mf and 5-mf fuzzy logic controller respectively. It shows that both controllers were able to cool test rooms to 23.4°C and 23.9°C even though lesser cooled air flow rate was supplied to the test rooms. Comparison of performances between case 1 and case 3 for 3-mf and 5-mf fuzzy controller was analyzed further in Figures 8 and 10. The results demonstrated that there was no significant difference in temperature variance between both cases. The final values of each test rooms for each case were tabulated in Table 6.

**Table 5** Initial conditions for simulation

Case	Initial conditions	
	$Q_{a1}$ ( $m^3/s$ )	$Q_{a2}$ ( $m^3/s$ )
1	0.2366	0.2366
2	0.2366	0.1578
3	0.1183	0.1183

**Table 6** Simulation results

Case	Type of controller	Simulation results	
		$T_{tr1}$ (°C)	$T_{tr2}$ (°C)
1	3-mf	23.4	23.4
	5-mf	23.9	23.9
2	3-mf	23.4	23.5
	5-mf	23.6	24
3	3mf	23.4	23.4
	5mf	23.9	23.9

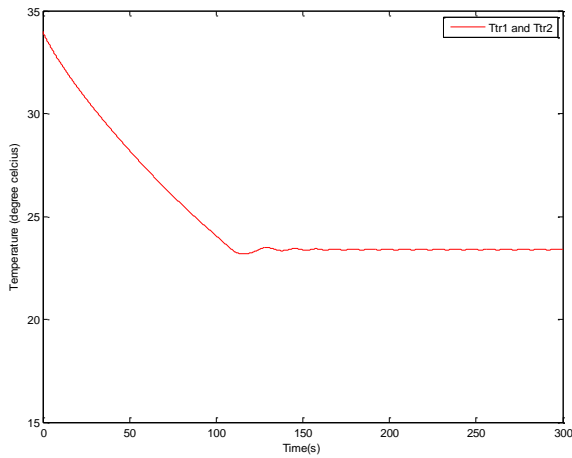

**Figure 2** The simulation results for case 1 of 3-mf fuzzy logic controller

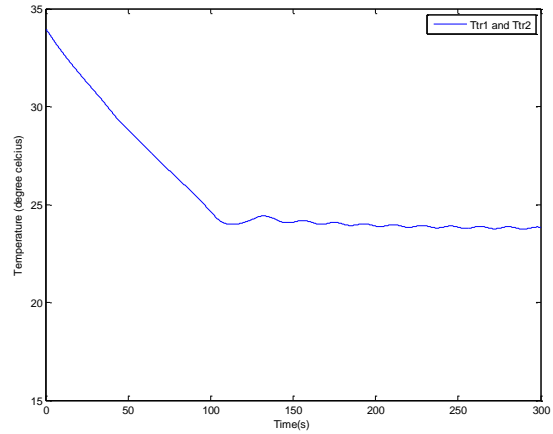

**Figure 3** The simulation results for case 1 of 5-mf fuzzy logic controller

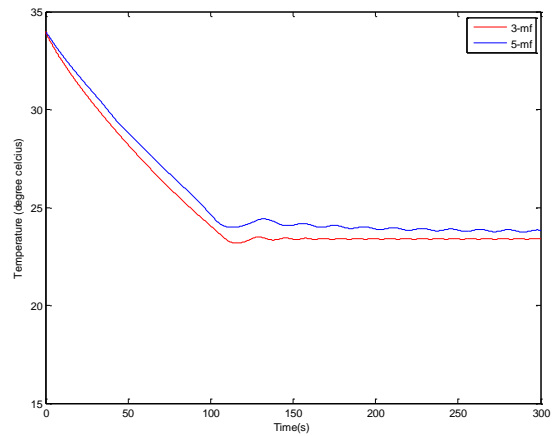

**Figure 4** The comparison between 3 and 5-mf fuzzy logic controller for case 1

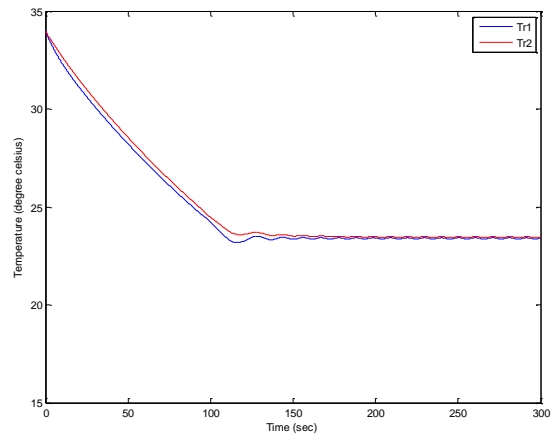

**Figure 5** The simulation results for case 2 of 3-mf fuzzy logic controller

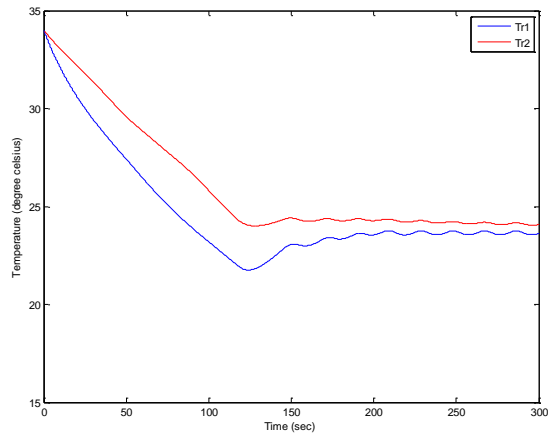

Figure 6 The simulation results for case 2 of 5-mf fuzzy logic controller

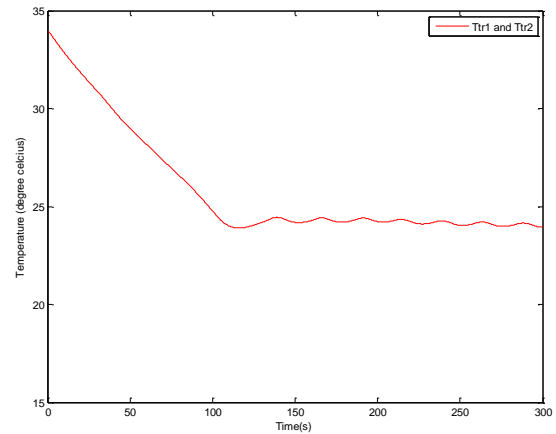

Figure 9 The simulation results for case 3 of 5-mf fuzzy logic controller

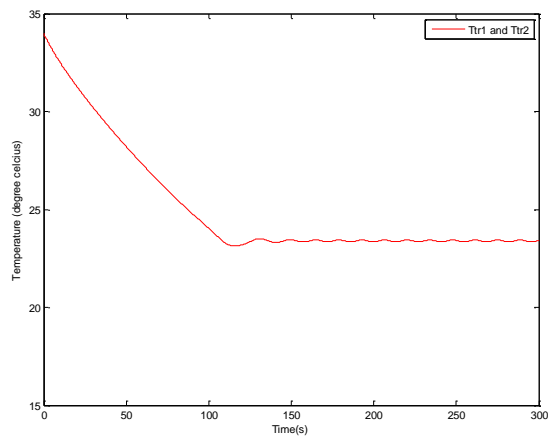

Figure 7 The simulation results for case 3 of 3-mf fuzzy logic controller

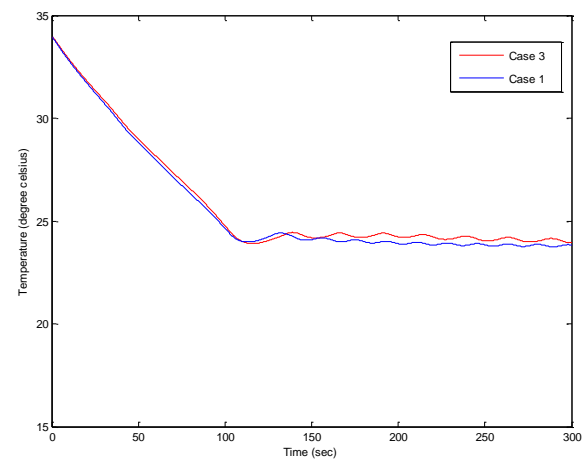

Figure 10 The comparison between case 1 and 3 of 5-mf fuzzy logic controller

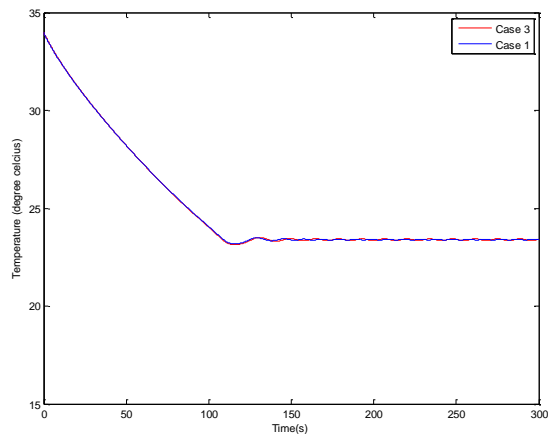

Figure 8 The comparison between case 1 and 3 of 3-mf fuzzy logic controller

## 5.0 CONCLUSIONS

This paper has presented the results of 3-membership function and 5-membership function fuzzy logic controller in the context of centralized chilled water system. The differences between both controllers were examined through two test rooms. Results show that both controllers were able to cool the test rooms to the desired temperature values even though various initial conditions were set in the simulation. The performances between them were almost similar. In Case 2 it was found that 3-mf fuzzy logic controller has lesser temperature variation as compared to 5-mf logic controller. It showed that the 3-mf fuzzy logic controller can maintain same temperature at both test rooms better than 5-mf fuzzy controller even though one of the test rooms received lesser supplied air flow rate. Most probably it happened because the membership function and scaling factor used in this work were not properly tune. Further in the future, other types of membership functions can be used to obtain better results. However, overall, there was no significant difference in terms of performance between both controllers.

### Acknowledgement

The authors would like to thank the Ministry of Education, Malaysia and Universiti Teknologi Malaysia for financially supporting this research project under the GUP Flagship Grant (Vot 05H19). The authors would also like to thank Universiti Teknikal Malaysia Melaka for the support.

### References

- [1] Ying, H., W. Siler and Buckley, J. J. 1990. Fuzzy Control Theory: A Nonlinear Case. *Automatica*. 26: 513–520.
- [2] Castro, J. R., Castillo, O. and Melin, P. 2007. An interval Type-2 Fuzzy Logic Toolbox for Control Applications, *FUZZ-IEEE 2007*, London.
- [3] Birkin, P. A. S. and Garibaldi, J. M. 2009. A Comparison of Type-1 and Type-2 Fuzzy Controllers in a Micro-Robot Context, *FUZZ-IEEE 2009*, Korea. 1857–1862.
- [4] Singh, J., N. and Sharma, J. K. 2006. Fuzzy Modeling and Control of HVAC Systems—A Review. *Journal of Scientific & Industrial Research*. 470–476.
- [5] Becker, M., Oestreich, D., Hasse, H. and Litz, L. 1994. Fuzzy Control for Temperature and Humidity in Refrigeration Systems. *IEEE Transaction*. 1607–1611.
- [6] Calvino, F., Gennusa, M. L., Rizzo, G. and Scaccianoce, G. 2004. The Control of Indoor Thermal Comfort Conditions: Introducing A Fuzzy Adaptive Controller. *Energy Buildings*. 36: 97–102.
- [7] Aprea, C., Mastrullo, R. and Renno, C. 2004. Fuzzy Control of the Compressor Speed in a Refrigeration Plan. *International Journal of Refrigeration*. 2: 134–143.
- [8] Soyguder, S., M., Karakose and Alli, H. 2009. Design and Simulation of Self-Tuning PID-Type Fuzzy Adaptive Control for an Expert HVAC System. *Expert System with Applications*. 36: 4566–4573.
- [9] Kim, K., Baek, J., Kim, E. and Park, M. 2005. TSK fuzzy Model Based Online Identification. *Eleventh International Fuzzy Systems Association World Congress*. 1435–1439.
- [10] Castillo, O. 2010. Interval Type-2 Fuzzy Logic for Control Applications. *2010 IEEE International Conference on Granular Computing*. 79–84.
- [11] Thosar, A., Patra, A. and Bhattacharyya, S. 2008. Feedback Linearization Based Control of a Variable Air Volume Air Conditioning System for Cooling Applications. *ISA Transactions*. 47: 339–349.
- [12] Reppa, V., Papadopoulos, P., Polycarpou, M. M. and Panayiotou, C. G. 2013. Distributed Detection and Isolation of Sensor Faults in Hvac Systems. *2013 21<sup>st</sup> Mediterranean Conference on Control & Automation*. 401–406.
- [13] Pravesh, A., Mohammadi, S.M.A. and Parvaresh, A. 2012. A New Mathematical Dynamic Model For HVAC System Components Based on MATLAB/SIMULINK. *International Journal of Innovative Technology and Exploring Engineering (IJITEE)*.
- [14] Salli, S. N. M. 2013. *Fuzzy Logic in Temperature Distribution Control*. Master thesis, UTM.
- [15] Wang, S., Wang, J. and Burnett, J. 2000. Mechanistic Model of Centrifugal Chillers for HVAC System Dynamics Simulation. *Building Serv Eng Res Technol* 2000. 21(73): 73–83.