

Adaptive Neuro-Fuzzy-based Vibration Approach for Structural Fault Diagnosis

S. J. S. Hakim^{1*}, A. F. Kamarudin¹, S. N. Mokhtar¹, Z. M. Jaini¹, S. Umar², N. Mohamad³, N. Jamaluddin³

¹Structural Dynamic and Computational Engineering, Faculty of Civil Engineering and Built Environment, University Tun Hussein Onn Malaysia, 86400 Parit Raja, Johor, MALAYSIA

²School of Civil Engineering, Faculty of Engineering, University Technology Malaysia, 81310 Skudai, Johor, MALAYSIA

³Department of Civil Engineering, Faculty of Civil Engineering and Built Environment, University Tun Hussein Onn Malaysia, 86400 Parit Raja, Johor, MALAYSIA

*Corresponding Author

DOI: <https://doi.org/10.30880/ijie.2022.14.06.034>

Received 13 January 2022; Accepted 15 August 2022; Available online 20 November 2022

Abstract: In recent times, damage identification based on vibration methods are emerging as common approaches, in which the techniques apply the vibration response of a monitored structure, such as modal frequencies and damping ratios, to evaluate its condition and detect structural damage. The basis of the vibration-based health monitoring method is that when there are alterations in the physical characteristics of a structure, there will also be changes in its vibration properties. This paper proposed a neuro-fuzzy artificial intelligence method, called adaptive neuro-fuzzy inference system (ANFIS), to detect damage using modal properties. To generate the modal characteristics of the structures, experimental study and finite element analysis of I-beams with single damage cases were performed. The results showed that the ANFIS approach was able to detect the magnitude and location of the damage with a significant degree of precision, and notably reduced computational time.

Keywords: Fault diagnosis, modal analysis, adaptive neuro-fuzzy inference system (ANFIS), finite element

1. Introduction

Damage is described as changes in structural properties, which may degrade the structural strength and adversely affects the functionality of a structure. Any drop in structural characteristics, such as stiffness, can affect the overall dynamic parameters of a structure. An alteration in the modal characteristics from an undamaged condition shows a potential damage in the given structure. Thus, it is necessary to accurately identify and detect structural changes from the modal parameters in the early stages [1]-[3].

Artificial intelligence approaches, such as artificial neural networks (ANNs) and fuzzy logic which parallel the significant capability of the human brain to learn in situations with uncertainty and inaccuracy, are very useful for solving inverse problems and have been used extensively for fault diagnosis in civil structures [4]-[8]. ANNs are highly efficient tools and have been developed to simulate complex problems in different fields of engineering and science. In addition, ANNs have the ability to learn the fundamental relationships in a set of data and then use that information to identify the output for different inputs [9]-[11]. Indeed, ANNs are very good at pattern recognition and can be trained properly from data and they can also generalise highly nonlinear mapping between diverse domains, but they are poor in term of reasoning capabilities [12], [13].

*Corresponding author: seyedhakim@uthm.edu.my

2022 UTHM Publisher. All rights reserved.

penerbit.uthm.edu.my/ojs/index.php/ijie

Fuzzy logic systems, on the contrary, can reason with inaccurate data and are great at describing their decisions, but do not have the learning ability and cannot modify themselves to adjust to a new environment. These limitations have encouraged researchers to create composite systems, where two or more intelligent methods are joined in a technique that overcomes the drawbacks of individual methods and attain better performance by utilising the proficiencies of each single technique. The adaptive neuro-fuzzy inference system (ANFIS) is the combination of both fuzzy logic systems and ANNs, which can take the benefits of both methods in a single structure.

ANFIS based on vibration parameters of a structure has been implemented for structural health monitoring and damage detection in a number of literatures. For example, the identification of damage in a beam structure using ANFIS was investigated by Fallahian & Seyedpoor [14]. In the said study, damage was defined as reduction in the modulus of elasticity in each element of the beam and modelled using finite element analysis. The natural frequencies of the structure were used as the input parameters. Results demonstrated that ANFIS could identify the damaged elements with a high percentage of accuracy.

The effect of damage on the first three modes of an isotropic beam using both ANN and ANFIS was presented by Banerjee et al. [15]. According to their study, ANFIS was able to predict the natural frequency of a damaged beam with an error of 1%, which demonstrated a high level of precision. In a different study, Zhu & Wu [16] proposed the method of structural damage detection based on dynamic vibration data, in which the authors employed ANFIS for structural damage detection purpose. According to their results, the proposed ANFIS approach was reliable for the detection of damage and prediction of the structural response. Next, implementation of ANFIS for damage detection of nonlinear truss structures was investigated by Salajegheh et al. [17]. In the said study, the ANFIS technique was implemented to identify the nodal displacement in truss structures. The presented ANFIS was compared with the results of ANN and indicated superior performance for assessing structure design values.

In another study, Das et al. [18] included the application of ANFIS to identify fatigue crack propagation of steel beam. The dynamic responses of the structure were measured in both undamaged and multiple damage states and experimental modal analysis was performed at each damaged stage. From the outcomes of their research, it was found that the ANFIS model demonstrated its efficiency quite acceptably. Damage detection in curvilinear beam structures using neural networks and ANFIS was also investigated by Saeed et al. [19]. The modal frequencies and frequency response functions (FRFs) of the undamaged and damaged structures at different locations were generated from finite element simulation and applied as the input parameters. Length and location of the cracks were considered as the output parameters. Principal component analysis (PCA) was used to decrease the dimension of the FRFs. The comparison of the error results showed that the multiple ANN and ANFIS combination achieved better results than the single ANN.

In this present research, the development, application and verification of ANFIS-based damage identification methods using modal data in I-beam structures were investigated. In the first step, the dynamic properties of the structures were extracted using experimental modal analysis and in the second step, the finite element analyses of both undamaged and damaged structures were implemented. The results showed that ANFIS, as an artificial intelligence method, could recognise the magnitude and detect the position of damage in the structures with a significant level of precision.

2. Adaptive Neuro-Fuzzy Inference System (ANFIS)

ANFIS was developed by Jang [20] and is a class of adaptive networks, which use the learning algorithms of both ANNs and fuzzy logic (FL) principles to take the advantages of both techniques. Using a specified dataset, ANFIS sets up a fuzzy system, whose membership functions (MFs) are modified using a hybrid approach, applying a combination of backpropagation (BP) algorithm and least mean square (LMS) [21]-[23]. The architecture of ANFIS, which has five layers, is depicted in Fig. 1. These layers perform multiplication, normalization, linear regression, and summation.

Each node in the first layer is an adaptive node and produces membership functions (MFs) of inputs, using several parameters. Each input has at least 2 MFs. Both Gaussian and bell-shaped are common membership functions used in fuzzy sets. Bell-shaped MFs have some advantages in ANFIS, such as being more flexible, than that of Gaussian MFs. Hence, the parameters of network would be more adjustable when using bell-shaped MFs. Parameters in layer 1 are called premise parameters $\{a_i, b_i, c_i\}$.

Moving on, every node in layers 2 and 3 is a fixed node and each node represents the firing strength of the rule. The output of the nodes in layer 3 is known as normalized firing strength. In the fourth layer, every node is an adaptive node function and computes the contribution of each rule toward the total output. Parameters in layer 4 are called consequent parameters $\{p_i, q_i, r_i\}$.

Finally, the single node in layer 5 is a fixed node, which basically calculates the total output of the system as the summation of all the received signals. ANFIS uses a hybrid algorithm to learn and compute the (i) consequence variables (p_i, q_i, r_i) via least mean square during the forward pass and (ii) premise variables (a_i, b_i, c_i) , updating using gradient descent during the backward pass. In the process of learning, the least mean square method is used to find the linear variables, while the non-linear variables (membership functions) are considered to be fixed. The gradient descent is applied to upgrade the non-linear variables, while the linear variables remain fixed.

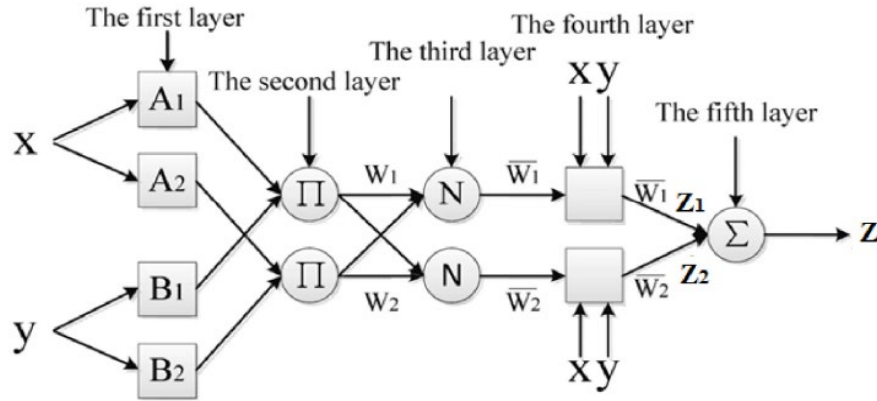

Fig. 1 - ANFIS architecture with a two-input first order Sugeno fuzzy model [24]

3. Experimental Study

Modal analysis is one of the key technologies in structural dynamics and uses a vibration base to determine damage in structures. Modal parameters are usually extracted from experimentally acquired time responses or frequency response functions (FRFs). However, it is more common to apply frequency-domain approaches than time-domain methods [25]-[28]. In the experimental study, the specifications of the tested specimens were expressed. Then, the modal analysis of the I-beam structure with respects to the variety of damage scenarios was described. In the last step, the dynamic parameters of both the intact and damaged structures were extracted.

In this research, four undamaged steel I-beams with a length of 3200 mm were considered. The dimensions of the structures included a flange width of 75 mm, thickness of 7 mm and 5 mm for the flange and web, respectively, and a section depth of 150 mm. In the experimental modal analysis, the specimens were excited using a shaker and the responses were measured by accelerometers. Then, the converted signals were analysed and the dynamic characteristics of the structures were determined. The set-up of the tested structure is as shown in Fig. 2.



Fig. 2 - Experimental test set up

In this study, from the modal analysis, all structures were experimented in their healthy condition and under various locations of damaged to extract the modal frequencies of the structures. In the first step, each structure was tested separately in its undamaged state. The first five modal frequencies of healthy beams are shown in Table 1. From this table, it was clear that, in higher mode shapes that were more challenging to acquire, the variations were more considerable than in lower modes that were simply acquired.

Table 1- Experimental results for the first five frequencies of healthy beams

Frequency Beam	F ₁	F ₂	F ₃	F ₄	F ₅
B1	56.21	202.01	440.95	709.42	951.21
B2	55.88	198.56	439.47	713.31	947.11
B3	55.74	206.16	440.26	716.21	967.21
B4	54.55	202.47	440.58	715.95	963.94

Also, different damage cases were generated in the structures. Damage scenarios were consisted of four positions with 25 magnitudes of severity for each position. Four beams named B1 to B4, were examined as single damaged by inflicting a slot by grinding at locations $L/2$, $2L/15$, $4L/15$ and $6L/15$ of the span length, respectively. The 25 damage cases with 5 mm breadth and depth of 3 to 75 mm with an interval of 3 mm were gently inflicted. The positions of the damage in beams B1 to B4 are demonstrated in Fig. 3.

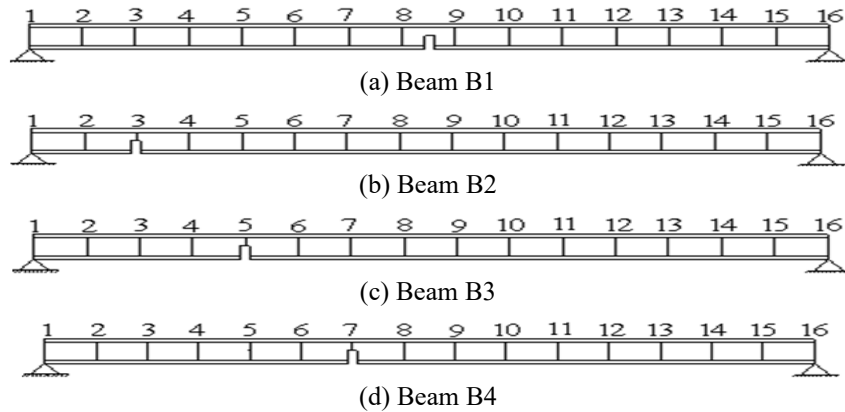

Fig. 3 - Location of single damages

The results of the natural frequencies for all the damaged state cases for beam B1 are depicted in Fig. 4. According to the damaged results, the maximum reductions of the natural frequency were 29.48%, 1.71%, 17.88%, 2.55% and 5.33% for mode 1 to mode 5, respectively. However, the values of the frequencies of the second and fourth modes were only slightly affected. To offer an explanation, in beam B1, where damage was imposed at mid-span, only minor changes had been observed for these two modes. The mid-span of the structure was the node point for modes 2 and 4. From Fig. 4, after increasing the inflicting damage from 3 mm to 75 mm, the frequencies decreased with the severity level. In beam B1 where the damage was located at the mid-span of the beam, the frequencies of modes 1, 3 and 5 were the most affected. Fig. 4 also specified that, the natural frequencies decreased with the rise in the level of damage and could be used as a criterion for fault diagnosis in civil structures.

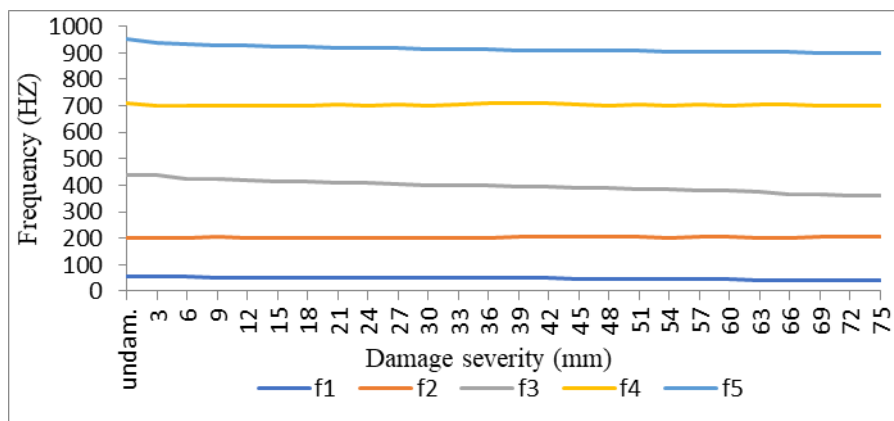

Fig. 4 - Natural frequencies of beam B1 for different damage severities

It is important to note that a mode shape is more sensitive at the location of the damage and provides more details about the location of the defect than natural frequencies. According to the results, changes in the mode shapes could happen with various levels of damage. The mode shape variations demonstrated that when the extent of defect was high, the mode shape alterations would also be larger. The results of the experimental modal analysis for beams B1 to B4 were saved and used for damage identification purpose using ANFIS.

4. Numerical Simulation

Finite element models were developed to simulate the modal analysis experiments. In this section, modal frequencies and mode shapes were attained by carrying out the numerical modal analysis of the undamaged beams and with different damage scenarios using Abaqus (Release 6.14). The I-beam model was simulated in its undamaged state to ascertain the first five flexural frequencies and mode shape magnitudes, as shown in Table 2.

Table 2 - Numerical results of natural frequencies (undamaged beam)

F ₁ (Hz)	F ₂ (Hz)	F ₃ (Hz)	F ₄ (Hz)	F ₅ (Hz)
54.39	209.01	443.13	732.84	1058

It could be seen from Table 2 and results from the experiment (i.e., Table 1), that only the first measured frequency was higher than the finite element model. This was caused by the stiffness of the support used in the experiment. To add further, the support used during the measurement had impact toward the dynamic behaviour of the structure. Other measured natural frequencies were lower than the numerical results due to the higher stiffness of the finite element model. The first five flexural mode shapes of the healthy model of the structure are demonstrated in Fig. 5, which clearly indicated that all the flexural modes were smooth functions that showed the non-presence of damages.

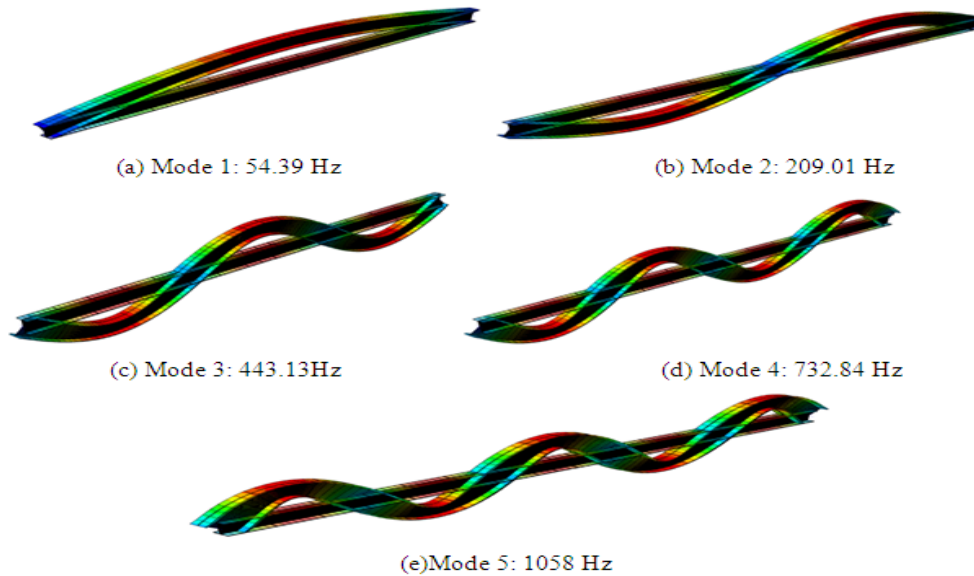

Fig. 5 - First five mode shapes of the undamaged beams

Damage was modelled by a rectangular opening at locations $L/2$, $2L/15$, $4L/15$ and $6L/15$ of the span length. The 25 damage severities were individually modelled, for each beam. The results demonstrated that the effect of damage was dependent on the location and magnitude of the damage. Fig. 6 shows the variations of the mode shape magnitudes with 75 mm damage to beam B1. The results indicated that when the damage was located at the mid-span of the beam, the natural frequencies of modes 1, 3 and 5 were the most affected. However, the natural frequency values of the second and fourth modes were only slightly affected. These results resonated with the described test results in the previous section.

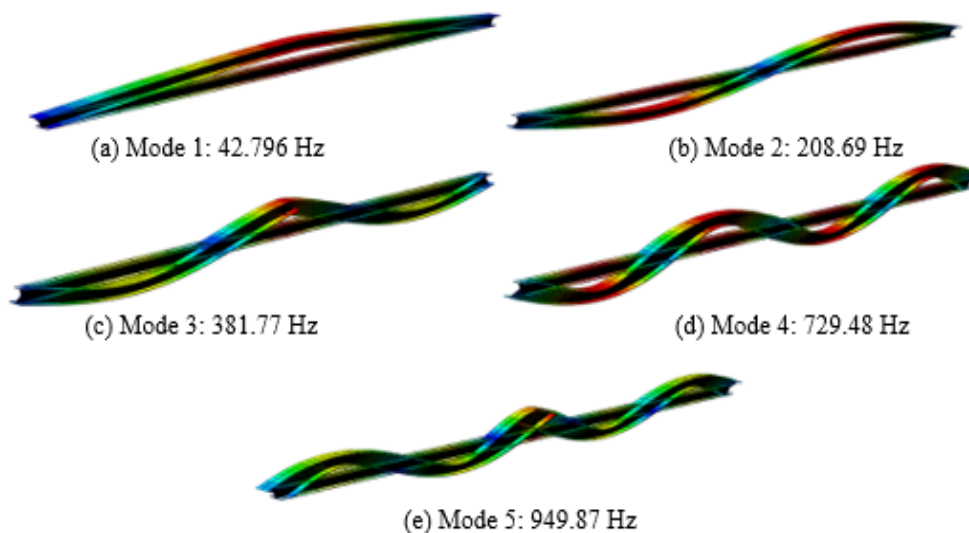

Fig. 6 - First five mode shapes of beam B1 after inducing 75 mm damage

5. Structural Damage Identification Using ANFIS

The ANFIS technique was developed to identify the magnitude and location of damage from the vibration data of the structure. The natural frequencies, which were the global characteristics of the structure, were used as the input parameters to identify the severity of the damage, while the mode shapes, which represented the local characteristics of the structure, were applied to recognise the location of the damage. The ANFIS method that was considered in this study consisted of five layers. The first and fourth layers were adaptive layers, while the second and third layers were fixed layers. Finally, since ANFIS had a single output, the damage severity or damage location was the output parameter, which also represented the fifth layer of the ANFIS model. In the following sections, the design of the ANFIS architecture to identify the magnitude and location of the damage was investigated.

5.1 Damage Severity

In this section ANFIS was trained with the first five flexural natural frequencies to identify the extent of damage in the I-beam structures. The inputs were (f_1) , (f_2) , (f_3) , (f_4) and (f_5) representing the first five natural frequencies of the structure. The training of ANFIS was performed to minimise the error between the output identified from ANFIS and the real target. During training, both the premise and consequent parameters were adjusted using hybrid algorithm. In order to achieve an output with higher precision, several ANFIS structures with different MFs, fuzzy rules and number of MFs were trained to attain the preferred structure of ANFIS. Types and number of MFs were changed to increase the functionality of ANFIS during training. The number of MFs allocated to each input was selected practically by trial and error, and the performance measure in terms of absolute error (AE) was applied to guarantee that the model had good generalisation capability. In this study, the MFs were bell shaped function. The parameters in the hybrid algorithm consisted of error tolerance, iteration number, initial step size, step size decrease and increase rates.

The number of iterations in the training step was fixed to 3000. The length of each gradient transition in the parameter space, which is called step size was 0.02 in this research. This value was in the range of 0.01 to 0.1 and could be changed to diverge the speed of convergence. According to the literature [29]-[31], the primary value of the step size is not significant for the final performance of ANFIS, as it is a very small value. The number of MFs for each input was fixed to 18 to reach an acceptable level after training. The architecture of the proposed ANFIS model for damage severity in the I-beam structure is depicted in Fig. 7. According to this architecture, 18 fuzzy MFs and 18 rules for layers 2 and 3 were generated, with regard to the five inputs. After the training phase, the ANFIS model was used to identify the severity of damage in the structure. The efficiency of the trained ANFIS model was checked using the testing datasets to the network. For this purpose, 62 datasets were used.

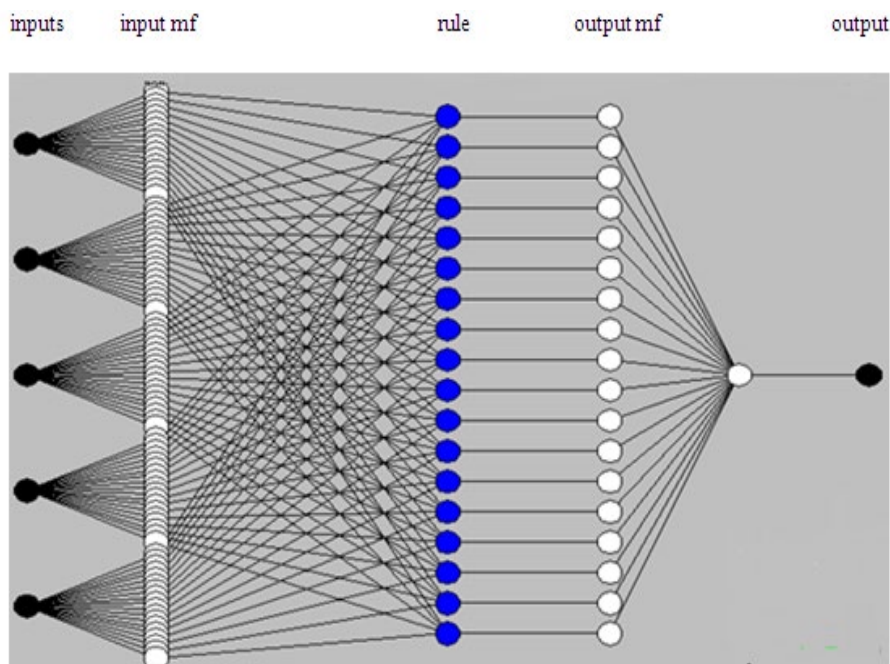

Fig. 7 - The structure of ANFIS for the identification of damage severity

The comparison between the identified damage severity via ANFIS and testing datasets is shown in Fig. 8. The results indicated that ANFIS could identify the extent of damage with an AE of 0.86% for the testing datasets. The coefficient of correlation rose to 0.9941 for the testing data and demonstrated that the results of ANFIS were similar to the targets. A correlation analysis was also carried out to illustrate the strength of the relationship between the actual

results from the finite element modelling and experimental modal analysis with the damage severity results from ANFIS.

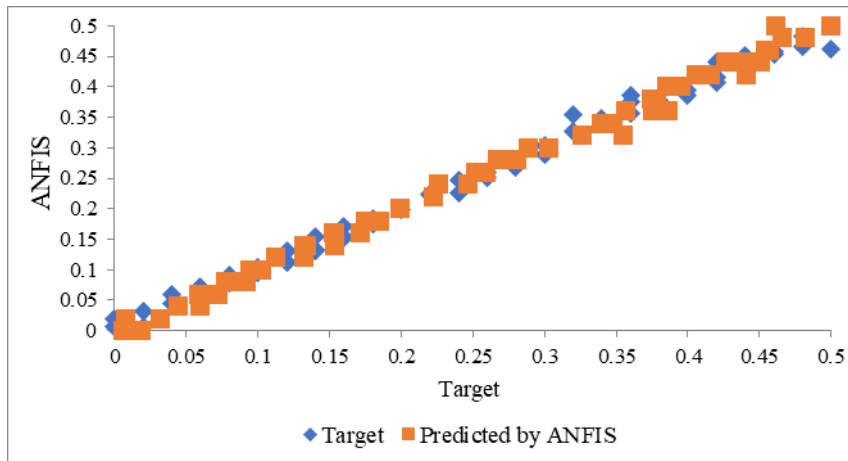

Fig. 8 - Comparison of damage severity through ANFIS and the testing datasets

The results of comparison showed that in beams B1 and B4, AE was below 0.65%, except for mode 5 (approximately 1.23%). Also, in beams B2 and B3 the AE for modes 1, 3 and 4 was less than 0.71%, which showed a good correlation between the actual and predicted results. It is worth mentioning that the variations of AE between the actual and identified data in some cases were even less than 0.5%. For example, in beam B1 for mode 1, AE was 0.48%, except for the severities of 69, 72 and 75 mm, which were 1.42%, 1.95% and 2.64%, respectively. The results demonstrated a very good correlation between the identified damage and actual datasets, and they proved that the developed ANFIS could be used as a very good approach for the recognition of damage extent in structures.

5.2 Damage Localisation

In this section, the possibility of using the ANFIS model for damage localisation in the I-beam structure is studied. Damage datasets was obtained from all the mode shape values consisting of 14 inputs at the points on the centreline of the beam. Damage location of the beam in terms of the ratio of location of damage from the support to the beam length (l_d/L) was considered as the output of ANFIS. The training of ANFIS was initiated with 208 datasets from different damaged scenarios of beams B1 to B4. The datasets were randomly divided into two sets with 146 and 62 samples for training and testing, respectively. The input layer of ANFIS for each mode had 14 nodes including all mode shape values at the points on the centreline of the structure. Therefore, the inputs and output of ANFIS for modes 1 to 5 come in the form of an array, which was given as:

- Mode 1: $\{\phi_{1,2}, \phi_{1,3}, \phi_{1,4}, \phi_{1,5}, \phi_{1,6}, \phi_{1,7}, \phi_{1,8}, \phi_{1,9}, \phi_{1,10}, \phi_{1,11}, \phi_{1,12}, \phi_{1,13}, \phi_{1,14}, \phi_{1,15}, l_d/L\}$
- Mode 2: $\{\phi_{2,2}, \phi_{2,3}, \phi_{2,4}, \phi_{2,5}, \phi_{2,6}, \phi_{2,7}, \phi_{2,8}, \phi_{2,9}, \phi_{2,10}, \phi_{2,11}, \phi_{2,12}, \phi_{2,13}, \phi_{2,14}, \phi_{2,15}, l_d/L\}$
- Mode 3: $\{\phi_{3,2}, \phi_{3,3}, \phi_{3,4}, \phi_{3,5}, \phi_{3,6}, \phi_{3,7}, \phi_{3,8}, \phi_{3,9}, \phi_{3,10}, \phi_{3,11}, \phi_{3,12}, \phi_{3,13}, \phi_{3,14}, \phi_{3,15}, l_d/L\}$
- Mode 4: $\{\phi_{4,2}, \phi_{4,3}, \phi_{4,4}, \phi_{4,5}, \phi_{4,6}, \phi_{4,7}, \phi_{4,8}, \phi_{4,9}, \phi_{4,10}, \phi_{4,11}, \phi_{4,12}, \phi_{4,13}, \phi_{4,14}, \phi_{4,15}, l_d/L\}$
- Mode 5: $\{\phi_{5,2}, \phi_{5,3}, \phi_{5,4}, \phi_{5,5}, \phi_{5,6}, \phi_{5,7}, \phi_{5,8}, \phi_{5,9}, \phi_{5,10}, \phi_{5,11}, \phi_{5,12}, \phi_{5,13}, \phi_{5,14}, \phi_{5,15}, l_d/L\}$

During the training procedure, the number of MFs was progressively increased, to reduce the error, and thus, the best possible structure with suitable MF parameters was obtained. The number of iterations was set to 3000 and training procedure was completed for all modes. The number of MFs for each input neuron was fixed to 23 to define the input and output parameters, until ANFIS attained an acceptable level after training. Fig. 9 presents the structure of ANFIS to identify damage location of the I-beam. According to this architecture, 23 fuzzy MFs and 23 rules for layers 2 and 3 were generated, with regard to the 14 inputs.

The performance of the ANFIS model to locate damage in the structure for modes 1 to 5 was tested using testing datasets and the results are shown in Fig. 10. According to the results from Fig. 10, ANFIS recognised the location of damage with AE of 1.088%, 1.81%, 1.14%, 1.76% and 1.97% for modes 1 to 5, respectively, for testing datasets. Fig. 10 demonstrated that the results identified by ANFIS using modes 1 to 5 were very close to the actual values. The performance and statistics of the selected architecture for all modes using ANFIS are tabulated in Table 3. From the ANFIS results in Fig. 10 and Table 3, it was observed that the networks of modes 1 and 3 with minimum AE values of 1.09% and 1.14% for the testing datasets performed the best, compared to the other networks. Larger errors were

achieved by the ANFIS for modes 2, 4 and 5. The higher AE for modes 2 and 4 were due to the existence of the node points of these modes.

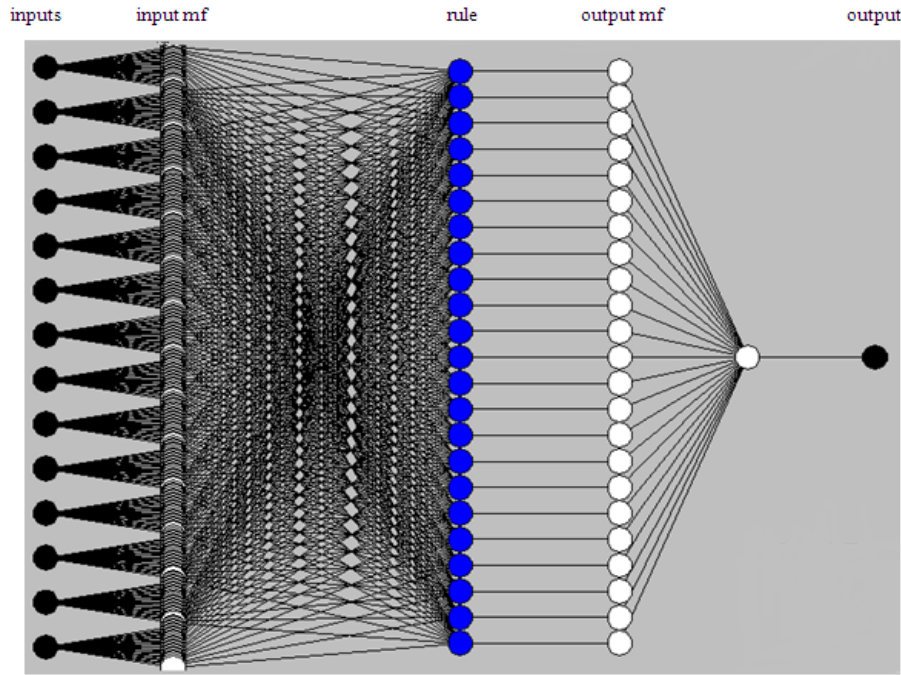
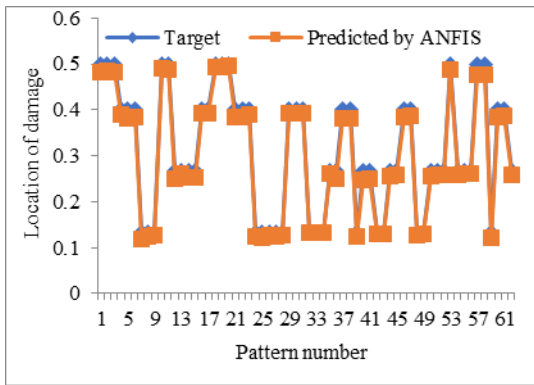

Fig. 9 - The structure of ANFIS for damage location identification

Table 3- Statistics of all modes using ANFIS for damage location identification

Network of M1		Network of M2		Network of M3		Network of M4		Network of M5	
AE	R ²	AE	R ²	AE	R ²	AE	R ²	AE	R ²
0.01088	0.9846	0.01811	0.9631	0.01144	0.9818	0.01761	0.9675	0.01972	0.9526



(a) mode 1

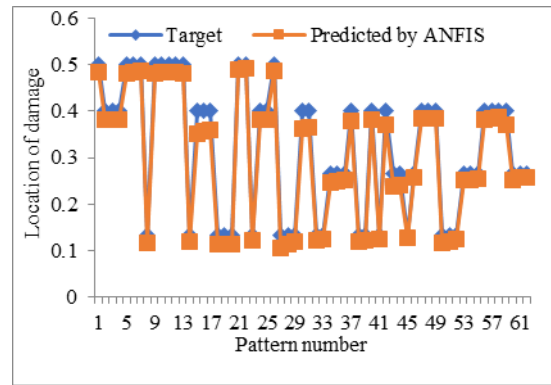

(b) mode 2

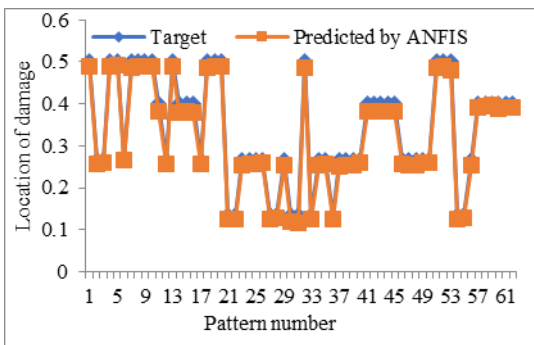

(c) mode 3

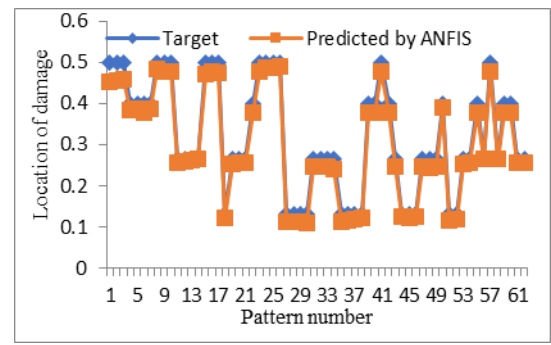

(d) mode 4

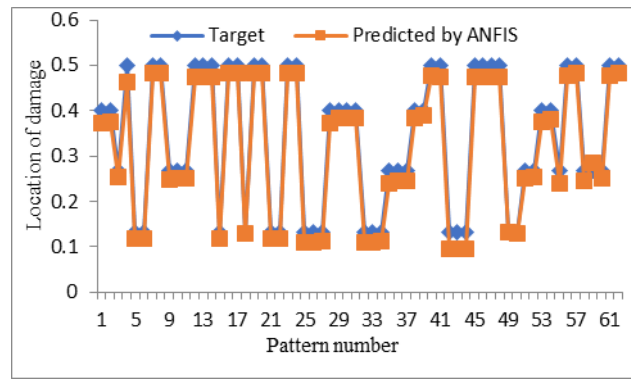

(e) mode 5

Fig. 10 - Damage location by ANFIS vs the actual data (first five modes)

The ANFIS results from mode 5 gave an AE of 1.97% and the correlation value of 0.9526. The unexpected errors during the extraction of higher mode shapes from the experimental modal analysis could be attributed as the reason for the larger error in mode 5. According to Table 3, the correlation coefficient values obtained were 0.9846, 0.9631, 0.9818, 0.9675 and 0.9526 for modes 1 to 5, respectively, for the testing datasets. These values indicated that ANFIS could provide good results for damage localisation using the mode shape values of structures. Thus, it exhibited good overall performance of ANFIS for the I-beam structure with very high correlation.

6. Conclusion

In this study, ANFIS was presented for the identification of single damage in I-beam structures. The vibration properties of the structures from finite element simulation and experimental modal analysis were used as the input parameters for the ANFIS model. Different ANFIS architectures with different types and number of MFs and fuzzy rules were trained, until the ANFIS model reached an acceptable level. According to the results of this study, the magnitude of damage in the I-beam was identified with a high degree of precision. The results further indicated that ANFIS could be used as a strong technique for the identification of damage severity in I-beam structures. Also, ANFIS managed to identify the location of damage in the I-beam structure. It was observed that, the performance of ANFIS provided good outcomes and demonstrated the applicability of ANFIS to identify the location of damage in I-beams with a high level of confidence.

Acknowledgement

This research was supported by Universiti Tun Hussein Onn Malaysia (UTHM) through Tier 1 (vot H905). The authors would like to acknowledge and expressed gratitude to all Structural Dynamic & Computational Engineering, JRC research members for their great cooperation to the accomplishment of this research.

References

- [1] Hakim S. J. S., Razak H. A., Ravanfar S. A. & Mohammadhassani M. (2014). Structural damage detection using soft computing method. *Structural Health Monitoring*, 5, 143-151. https://doi.org/10.1007/978-3-319-04570-2_1
- [2] Jaini Z. M., Feng Y.T., Owen D. R. J. & Mokhtar S. N. (2016). Fracture failure of reinforced concrete slabs subjected to blast loading using the combined finite-discrete element method. *Latin American Journal of Solids and Structures*, 13, 1086-1106. <https://doi.org/10.1590/1679-78252362>
- [3] Mokhtar S. N., Sonoda Y., Kueh A. B. H. & Jaini Z. M. (2015). Quantitative impact response analysis of reinforced concrete beam using the Smoothed Particle Hydrodynamics (SPH) method. *Structural Engineering and Mechanics*, 56 (6), 917-938. <http://dx.doi.org/10.12989/sem.2015.56.6.917>
- [4] Nick H., Aziminejad A., Hosseini M. H. & Laknejadi K. (2021). Damage identification in steel girder bridges using modal strain energy-based damage index method and artificial neural network. *Engineering Failure Analysis*, 119, 1-20. <https://doi.org/10.1016/j.engfailanal.2020.105010>
- [5] Ravanfar S. A., Razak H. A., Ismail Z. & Hakim S. J. S. (2016). A two-step damage identification approach for beam structures based on wavelet transform and genetic algorithm. *Meccanica*, 51 (3), 635-653. <https://doi.org/10.22075/jrce.2017.11678.1197>
- [6] Hakim S. J. S., Mokhtar S. N., Shahidan S., Chik T. N. T., Jaini Z. M., Abd Ghafar N. H. & Kamarudin A. F. (2021). An ensemble neural network for damage identification in steel girder bridge structure using vibration data. *Civil Engineering and Architecture*, 9 (2), 523-532. <https://doi.org/10.13189/cea.2021.090225>

- [7] Hakim S. J. S., Razak H. A. & Ravanfar S. A. (2014). Modal parameters based structural damage detection using artificial neural networks-a review. *Smart Structures and Systems, an International Journal*, 14(2), 159-189. <https://doi.org/10.12989/sss.2014.14.2.159>
- [8] Ravanfar S. A., Razak H. A., Ismail Z. & Hakim S. J. S. (2016). A hybrid wavelet based–approach and genetic algorithm to detect damage in beam-like structures without baseline data. *Experimental Mechanics*, 56(8), 1411-1426. <https://doi.org/10.1007/s11340-016-0181-y>
- [9] Hakim S. J. S. & Razak H. A. (2012). Damage identification using experimental modal analysis and adaptive neuro-fuzzy interface system (ANFIS). In Allemang R. et al. (Eds.), *Topics in Modal Analysis I*, 5, 399–405. https://doi.org/10.1007/978-1-4614-2425-3_37
- [10] Noorzaei J., Hakim S. J. S., Jaafar M. S., Abang A. A. A. & Thanoon W. A. M. (2007). An optimal architecture of artificial neural network for predicting compressive strength of concrete. *Indian Concrete Journal*, 81(8), 17–24.
- [11] Ravanfar S. A., Razak H. A., Ismail Z. & Hakim S. J. S. (2015). A hybrid procedure for structural damage identification in beam-like structures using wavelet analysis. *Advances in Structural Engineering*, 18 (11), 1901-1913. <https://doi.org/10.1260/1369-4332.18.11.1901>
- [12] Hakim S. J. S., Razak H. A. & Ravanfar S. A. (2016). Ensemble neural networks for structural damage identification using modal data. *International Journal of Damage Mechanics*. 25(3), 400-430. <https://doi.org/1056789515598639>
- [13] Hakim S. J. S. & Razak H. A. (2014). Frequency response function-based structural damage identification using ANNs-a review. *Research Journal of Applied Sciences, Engineering and Technology*, 7(9), 1750-1764. <https://doi.org/10.19026/rjaset.7.459>
- [14] Fallahian S. & Seyedpoor S. M. (2010). A two-stage method for structural damage identification using an adaptive neuro-fuzzy inference system and particle swarm optimization. *Asian Journal of Civil Engineering (Building and Housing)*, 11(6), 795-808.
- [15] Banerjee A., Pohit G. & Panigrahi B. (2017). Vibration analysis and prediction natural frequencies of cracked Timoshenko beam by two optimization techniques- cascade ANN and ANFIS. *Materials Today: Proceeding of the International Conference on Recent Trends in Engineering and Material Sciences*, 4(9), 9909–9913. <https://doi.org/10.1016/j.matpr.2017.06.292>
- [16] Zhu F. & Wu Y. (2014). A rapid structural damage detection method using integrated ANFIS and interval modelling technique. *Applied Soft Computing*, 25, 473–484. <https://doi.org/10.1016/j.asoc.2014.08.043>
- [17] Salajegheh E., Salajegheh J., Seyedpoor S. M. & Khatibinia M. (2009). Optimal design of geometrically nonlinear space trusses using an adaptive neuro-fuzzy inference system. *Scientia Iranica*, 16, 403-414.
- [18] Das S., Nayak B., Sarangi S. K. & Biswal D. K. (2016). Condition monitoring of robust damage of cantilever shaft using experimental and adaptive neuro-fuzzy inference system (ANFIS). *Procedia Engineering*, 144, 328-335. <https://doi.org/10.1016/j.proeng.2016.05.140>
- [19] Saeed R. A., Galybin A. N. & Popov V. (2012). Crack identification in curvilinear beams by using ANN and ANFIS based on natural frequencies and frequency response functions. *Neural Computing and Application*, 21(7), 1629-1645. <https://doi.org/10.1007/s00521-011-0716-1>
- [20] Jang J. S. R. (1993). ANFIS: Adaptive network-based fuzzy inference systems. *IEEE Transactions on Systems, Man, and Cybernetics*, 23(3), 665-685.
- [21] Akrami S. A., Nourani V. & Hakim S. J. S. (2014). Development of nonlinear model based on wavelet-ANFIS for rainfall forecasting at Klang Gates Dam. *Water Resources Management*, 28, 2999-3018. <https://doi.org/10.1007/s11269-014-0651-x>
- [22] Mohammadhassani M., Nezamabadipour H., Jumaat Z. M., Jameel M., Hakim S. J. S. & Zargar M. (2013). Application of the ANFIS model in deflection prediction of concrete deep beam. *Structural engineering and mechanics*, 45(3), 319-332. <https://doi.org/10.12989/sem.2013.45.3.323>
- [23] Hakim S. J. S. & Razak H. A. (2011). Application of artificial neural network on vibration test data for damage identification in bridge girder. *International Journal of the Physical Sciences*, 6(35), 7991- 8001. <https://doi.org/10.5897/ijps11.1198>.
- [24] Gill J. & Singh J. (2017). Performance analysis of vapor compression refrigeration system using an adaptive neuro-fuzzy inference system. *International Journal of Refrigeration*, 82, 436-446. <https://doi.org/10.1016/j.ijrefrig.2017.06.019>
- [25] Chik T. N. T., Rou C. S., Kamarudin A. F., Hakim S. J. S., Yusoff N. A. (2021). Vibration criteria assessment due to piling works. *International Journal of Integrated Engineering*, 2021, 13(3), 46-56. <https://doi.org/10.30880/ijie.2021.13.03.006>
- [26] Saito A. & Kuno T. (2020). Data-driven experimental modal analysis by dynamic mode decomposition. *Journal of Sound and Vibration*, 481, 1-17. <https://doi.org/10.1016/j.jsv.2020.115434>
- [27] Hakim S. J. S., Ravanfar S. A. & Yeow, D. (2020). A sensitivity analysis on the damage identification capability of artificial neural networks. *International Refereed Journal of Engineering and Science*, 9(3), 9-17. <https://doi.org/10.183x/B09030917>

- [28] Mohammadhassani M., Jumaat M. Z. B., Chemrouk M, Ghasemi A., Hakim S. J. S. & Najmeh R. (2011). An experimental investigation of the stress-strain distribution in high strength concrete deep beams. *Procedia Engineering*, 14, 2141-2150. <https://doi.org/10.1016/j.proeng.2011.07.269>
- [29] Jang J. S. R. (1992). Self-learning fuzzy controllers based on temporal backpropagation. *IEEE Transactions on Neural Networks*, 3(5), 714-723.
- [30] Hakim S. J. S., Ibrahim M. H. W., Mohammadhassani M., Yeoh D., Jaini Z. M. & Chik T. N. T. (2022). Implementing fuzzy-based artificial intelligence approach for location of damage in structures. *Civil Engineering and Architecture*, 10(4), 1564-1573. <https://doi.org/10.13189/cea.2022.100426>
- [31] Hakim S. J. S., Irwan J. M., Ibrahim M. H. W. & Ayop S. S. (2022). Structural damage identification employing hybrid intelligence using artificial neural networks and vibration-based methods. *The Journal of Applied Research and Technology*, 20 (2), 221-236. <https://doi.org/10.22201/icat.24486736e.2022.20.2.1233>