

Article

Coconut Fibre and Sawdust as Green Building Materials: A Laboratory Assessment on Physical and Mechanical Properties of Particleboards

Dg Normaswana binti Tawasil ^{1,*}, Eeydzah Aminudin ¹, Nor Hasanah Abdul Shukor Lim ¹,
Nik Mohd Zaini Nik Soh ², Pau Chung Leng ³, Gabriel Hoh Teck Ling ³ and Mohd Hamdan Ahmad ³

- ¹ Faculty of Engineering, School of Civil Engineering, Universiti Teknologi Malaysia, Skudai 81300, Johor, Malaysia; eeydzah@utm.my (E.A.); norhasanah@utm.my (N.H.A.S.L.)
² Department of Civil Engineering & Technology, Faculty of Civil & Environmental Engineering, Universiti Tun Hussein Onn Malaysia, Parit Raja 86400, Johor, Malaysia; nikzaini@uthm.edu.my
³ Faculty of Built Environment & Surveying, University Teknologi Malaysia, Skudai 81300, Johor, Malaysia; pleng2@utm.my (P.C.L.); gabriel.ling@utm.my (G.H.T.L.); b-hamdan@utm.my (M.H.A.)
* Correspondence: wannatawasil@gmail.com; Tel.: +60-14-6536930

Abstract: This paper evaluates, via a laboratory assessment, the physical properties (BS EN 323:1993, BS EN 324) and mechanical performance (BS EN 310:1993) of hybrid particleboards using agricultural wastes, namely coconut fibre and sawdust. The process begins with the preparation of the materials where they are sieved and retained with the 5-mm sieve and then oven-dried. The hybrid particleboard mixed with the addition of resin (urea formaldehyde) was sprayed and hot pressed. The hot press temperature was set at 180 °C, with the resin content of 8 wt.% and the design density of 650 kg/m³ used in producing the particleboard. The percentage/ratio of the composition of sawdust (SD) to coconut fibre (CF) varied ranging from 100SD:0CF to 70SD:30CF, 50SD:50CF, 30SD:70CF, and 0SD:100CF. Meanwhile, as for the thickness of the boards, it was categorised into three groups which are 16 mm, 20 mm, and 32 mm. The particleboards were conditioned to the room temperature for seven days before being tested for physical properties and mechanical performances. The results show that the most optimum composition of sawdust to coconut fibre is 0% sawdust to 100% coconut fibre (0SD:100CF) and the optimum thickness is 20 mm, where its density is 761.99 kg/m³, swelling thickness is 11.98%, and water absorption at 37.64%. With the modulus of elasticity of 1510 N/mm², the modulus of rupture of 17.8 N/mm², and the internal bonding of 1.08 N/mm², they satisfied the universal standard of Particleboard Type P3 of BS EN 312:2010.

Keywords: green building; waste materials; particleboard; coconut fibre; sawdust; physical properties; mechanical performances



Citation: Tawasil, D.N.b.; Aminudin, E.; Abdul Shukor Lim, N.H.; Nik Soh, N.M.Z.; Leng, P.C.; Ling, G.H.T.; Ahmad, M.H. Coconut Fibre and Sawdust as Green Building Materials: A Laboratory Assessment on Physical and Mechanical Properties of Particleboards. *Buildings* **2021**, *11*, 256. <https://doi.org/10.3390/buildings11060256>

Academic Editors: João Gomes Ferreira and Ana Isabel Marques

Received: 26 April 2021
Accepted: 13 June 2021
Published: 16 June 2021

Publisher's Note: MDPI stays neutral with regard to jurisdictional claims in published maps and institutional affiliations.



Copyright: © 2021 by the authors. Licensee MDPI, Basel, Switzerland. This article is an open access article distributed under the terms and conditions of the Creative Commons Attribution (CC BY) license (<https://creativecommons.org/licenses/by/4.0/>).

1. Introduction

According to Eurostat (2017), the pulp and paper and solid wood products industries accounted for around 4.4% (€277 billion) of total EU manufacturing production value and 5.4% (1.61 million) of total EU manufacturing employment in 2013. If forestry and logging, as well as downstream wood-based industries, are included, the sector's importance grows significantly (furniture, energy, chemicals, and so on). Major structural changes are taking place in the worldwide and European forest-based industries. The consumption and production of wood-based products are shifting away from the traditionally dominant forest sector regions of North America, Western Europe, and Japan, and toward the rapidly rising big economies of China, Brazil, and India [1]. Wood-based composite materials can be composed of a variety of wood elements, such as fibres, particles, flakes, veneers, or laminates. These materials' properties can be altered by mixing, rearranging, or stratifying these elements. When raw material selection is combined with well-chosen processing variables, the end output can outperform nature's best efforts.

At the moment, the term composite refers to any wood substance that has been adhesively glued together. This includes a wide range of products, from fibreboard through laminated beams and components [2]. Wood-based composites are employed in a variety of structural and non-structural applications. Panels for both indoor and external use, furniture components, and structural support structures are all part of the product line. Understanding the mechanical qualities of these items is crucial for their proper use. The performance of wood-based composites is characterised by a wide range of engineering features. Mechanical characteristics are commonly utilised to assess wood-based composites for structural and non-structural applications. The fundamental factors for selecting materials or establishing design or product specifications are elastic and strength properties [3].

Construction has been a significant human endeavor and one of the most critical fields of industry for centuries. However, advances in the manufacturing of building materials, as well as the construction industry in general, have a substantial effect on the environment in terms of energy demand, usage of natural resources, and environmental pollution. In reality, building materials use 24% of the extracted raw materials from the lithosphere, a figure that will only rise in the coming years as the world and developing-country populations grow. Several studies have shown that the construction industry's present state is unsustainable in the long run [4]. The method of valorizing wastes into more usable products is an effective way of dealing with waste and, as a result, increasing competition in bio-refineries that can produce a diverse variety of products using waste as feedstock [5]. Since, in addition to the decrease of raw materials used, the problem of waste caused by industrial civilization is being addressed gradually, there is a greater emphasis on the use of waste and by goods. Data from 2010 revealed that waste production in the European Union was 2.5 billion tonnes, a 25% increase from 2006 (European Commission, 2015). Reusing or valorizing these wastes may thus be a profitable way to solve this issue [4].

The use of spent coffee grounds (SCG) as an addition in brick manufacturing was also investigated. Munoz et al. engineered SCG bricks and discovered bricks with a compressive strength of more than 17% SCG waste above 10 N/mm², allowing them to be used structurally. The thermal conductivity of these bricks was also reduced by 50%, making them better insulators than standard bricks. A study on bricks partially composed of SCG discovered that up to 10% SCG already had the best grade of mechanical standards, and the addition of 20% reduced thermal conductivity by 70% [6]. Agricultural wastes, such as oil palm, pineapple leaves, sugarcane bagasse powder, fly ash, kraft pulp, coconut coir, rice husk, rice straw, kenaf, jute, hemp, corncob, and sawdust were mostly used in the manufacture of cement-based composites. According to Abdullah (2017), despite the material's decreased compressive and flexural strength, the fibre content increases. According to one report, the mechanical properties of clay brick made from oil palm fruit and pineapple leaves meet the minimum requirements for traditional bricks, and the addition of fibre decreases brick density. It was also discovered that a composite of recycled municipal waste sludge, bagasse, and sludge had a high compressive strength value [7].

Against the above background, the objective of this study is to evaluate the physical properties and mechanical performances of a wood-based panel, which is a particleboard using agriculture wastes, namely coconut fibre and sawdust as green materials. The physical properties and mechanical performance of particleboard are determined by the three key variables of (i) different mix designs or compositions of sawdust to coconut fibre in percentage; (ii) resin content; and (iii) thickness groups (16 mm, 20 mm, and 32 mm). Ultimately, the optimum composition of sawdust to coconut fibre as well as thickness groups will be addressed.

1.1. Composition of Waste Material, Resin Content and Hot-Press Temperature Utilized in Particleboard Making Process

The manufacture of fibreboards from coconut husks was studied in 2004 and it was discovered that coconut coir and fibre have a percentage of lignin that is more than 130 °C heat thermally robust and can create fibreboards without the use of chemical

binders [8]. Particleboards now have a multitude of properties, including optimal design stability for simple assembly lines, reliable quality, dimensional range, and user-friendly physical characteristics. They can be used for a variety of purposes, including office and residential furniture, soundproofing, home decking, ceiling, roofing, and shuttering, cabinets, partitioning, cladding stair treads, underlying floor, table, shelving, store fixtures, wall bracing, ceiling boarding, home constructions, sliding doors, kitchen shelves, interior signs, exam pad, photo lamination, and for low-cost cabins.

Many factors can affect particleboard characteristics, including wood species, fibre structures, stiffness, hardness, compressibility, particle shape and size, and particle drying technology [9]. The medium-size particle performed well for binder-less and melamine urea formaldehyde (MUF) bonded boards. When 16% MUF was used, the bonded board of MUF performed best. According to Ahmed (2016), the product consistency with 16% MUF is superior to binder-less coir pith board. Coconut coir board, as well as wood replacements, will provide sustainable, inexpensive, and long-lasting materials for building and packaging [10]. At a low cost, urea formaldehyde is often used for indoor panels. However, these binders are not waterproof and emit poisonous and carcinogenic formaldehyde. Many of these binders are hazardous to one's health and the environment. It is well known that reducing the use of formaldehyde causes poor mechanical properties of particle boards. Since reducing formaldehyde does not eliminate harmful emissions, this negative impact is reduced by plating or chemical modifications [11].

According to El-Kassas et al. (2013), the properties of the manufactured fiberboards are affected by the average density and resin content [12]. Akinyemi (2016) discovered in his analysis that panel density rose as sawdust composition decreased, reaching a plateau at 25% before plummeting dramatically. However, as the proportion of corn cob rose, particleboard density increased significantly, but a substantial decrease was observed after the plateau at 75% corn cob. The density of the corn cob panels was smaller than that of the sawdust panels. The obtained density is comparable to particleboard densities between 590 and 800 kg/m³ in the wood processing industries [13]. Paridah (2014) discovered that particleboards with 10% resin and 50:50 (RW: KS) have the best strength (19.08 MPa), whereas particleboards with 70:30 (RW: KS) have a higher strength (2.23 GPa). The RW: KS ratio has a greater influence on thickness swelling (TS) and water absorption (WA) than the resin level. Hybrid particleboards made of 70% RW, 30% KS, and 10% resin material exhibit all positive properties and are equal to 100% RW (control) samples. It was concluded that kenaf stem would replace rubber-wood particles up to 50%, but resin levels must be kept at 10% or higher because a lower level of resin (68%) significantly decreases particleboard power [14].

The pre-pressed mats were pressed for 5 min in a hot press with the temperature and pressure set at 160 °C and 3 N/mm² respectively [10]. The pressing cycle was then carried out using the daylight press at a pressing plate temperature of 180 °C and sufficient pressure to achieve the desired panel density and thickness. The panel was pressed for 12–13 s per millimetre of thickness [12]. The pressing process has the following time, temperature, and pressing specifications: (i) for the high density (HDF) fibreboard, 220 °C and 320 kgf/cm² for 4 min; (ii) for the medium density (MDF) fibreboard, 210 °C and 320 kgf/cm² for 4 min.; (iii) and for the MDF UF fibreboard, 160 °C and 100 kgf/cm² for 10 min. When compared to conventional hot-pressing, which is typically performed by conduction heating from the surface, high frequency (HF) hot-pressing can significantly reduce pressing time, as shown in Figure 1 [15].

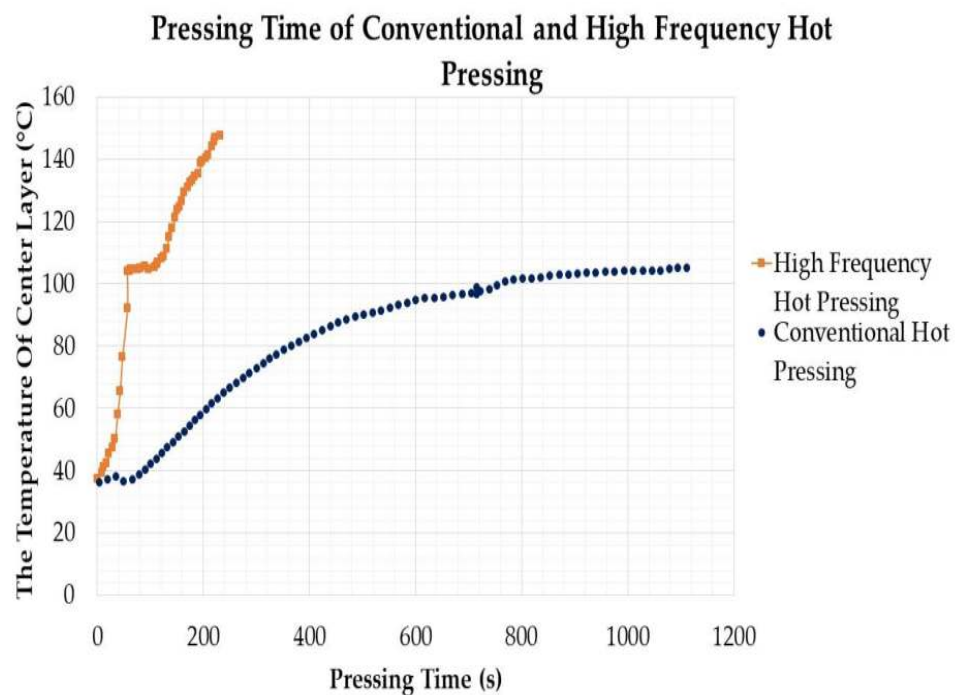

Figure 1. The graph of temperatures of center layer against pressing time [15].

1.2. Coconut Fibre as Green Material for Building

As alternatives to concrete formulation, various sources of natural fibres are investigated, which can be separated into two categories: field or agricultural waste and product crops. Agriculture waste types of natural fibres used in the formulation of green concrete and other construction materials include coconut coir, rice husks, palm oil fuel ash, bagasse, wood chips, bamboo leaf ash, bananas, wheat straw, stroke, and sisal, as well as natural fibre from commodity crops such as kenaf, jute, and hemp [16].

Coconut fibre is readily available. Several studies on the use of coconut fibre in a matrix polymer composite have been conducted. It has low thermal conductivity and a high weight-to-strength ratio. Coconut fibre is an excellent solution to potentially hazardous construction materials [17]. Coconut fibre is extracted from the external shell of a coconut fruit, also known as coir. Coconut is mostly cultivated in tropical and subtropical climates. Ghana produces approximately 305,000 tonnes of coconut per year, which generates a large amount of waste in the world. Coconut fibres are usually present in three forms: (1) long fibre bristle, (2) short fibre mattress, and (3) decorticated (mixed fibre lengths). Coconut fibre has not been widely used in manufacturing, but it has strong engineering properties. Coconut fibre measurements vary and are assumed to be affected by the form, position, and maturity of the coconut plant. The flexibility and breakup of the fibre are influenced by the length to diameter (aspect proportion) of the fibre, which defines its use. The primary constituents of coconut fibre are cellulose, hemicellulose, and lignin, which influence both the physical and mechanical properties of the fibre [18].

Coconut fibre is the toughest natural fibre because it contains more than 30% lignin, as seen in Table 1, which makes the fibres tougher and more rigid by providing compressive strength to the tissue and fibre as well as strengthening the cell wall to shield the carbohydrates from chemical or physical harm. Coconut fibres can be 4–6 times more strained than other fibres. Furthermore, when stored and exposed to sunshine, coconut fibre retains its power. The density of the coconut fibre is critical in deciding the total weight required for the coconut fibreboard panel. The use of coconut fibre in furniture production is increasing due to its properties. Coconut fibre is thicker than wood fibre according to research [19].

Table 1. Chemical Composition and Physical Properties of Coconut Fibre [19].

Chemical Composition (%)	Physical Properties
Halocellulose (56.3%)	Density = 1.2 g/cm ³
α -cellulose (44.2%)	Elongation at break = 30%
Lignin (32.8%)	Tensile Strength = 175 MPa
Ash (2.2%)	Young Modulus = 4 to 6 GPa
	Water Absorption = 130–180%

1.3. Research Gap

The Malaysian government has encouraged the construction industry to transition to an industrialized building system (IBS), which can deliver a large number of houses at a low cost, especially low-cost houses. Government agencies, such as Jabatan Kerja Raya (JKR) and the Construction Industry Development Board (CIDB), as well as academics, have played critical roles in educating the construction industry's key players through policies, financial incentives, strategy guides, conferences, and seminars to raise awareness among end users and clients. The industrialization of high-rise residential building components is vital to competitiveness and has emerged as a growing trend in order to address the housing crisis and satisfy the demand for affordable housing, especially in large cities with limited construction capacity. Almost all of Asia's big cities have apartment buildings that are high-rise and dense [20].

Concrete supplemented with green fibre and the thermal behaviours of the improved strength concrete have not been thoroughly studied. On the other hand, the green fibre or lignocellulose materials added in the production of wood-based composite building materials also demand further study. Moreover, the selected material used in this study, coconut fibre mix with sawdust particles, can be studied not only in terms of physical and mechanical properties. The particleboard could also be another innovative material for construction applications in future.

2. Materials and Methods

2.1. Research Design and Operational Framework

Hybrid fibre-particleboard was chosen, incorporating the use of sawdust particles and coconut fibre in a building material composite. Heveaboard (M) Sdn Bhd provided the sawdust particle and resin used in this analysis. Resin used in this study is urea-formaldehyde (UF) resin with a solid content of 64%. This UF resin is currently used on an industrial scale for particleboard manufacturing and has a dynamic viscosity of 150 to 250 cps at 30 °C and gel time reactivity of 120 to 160 s at 100 °C. Coconut fibre was made by shredding and grinding long fibres using a hammer mill crushing machine. Following that, the coconut fibre was sieved on a vibration table using a rectangle handmade wood sieve of 5 mm, 3 mm, 1 mm, and pan, as well as for sawdust. The sawdust and coconut fibre retained at 5 mm would then be separated for board production and particle size analysis using a vertical sieve shaker as shown in Figure 2. Both sawdust and coconut fibres were then oven-dried for 24 h at 80 °C to minimise moisture content.

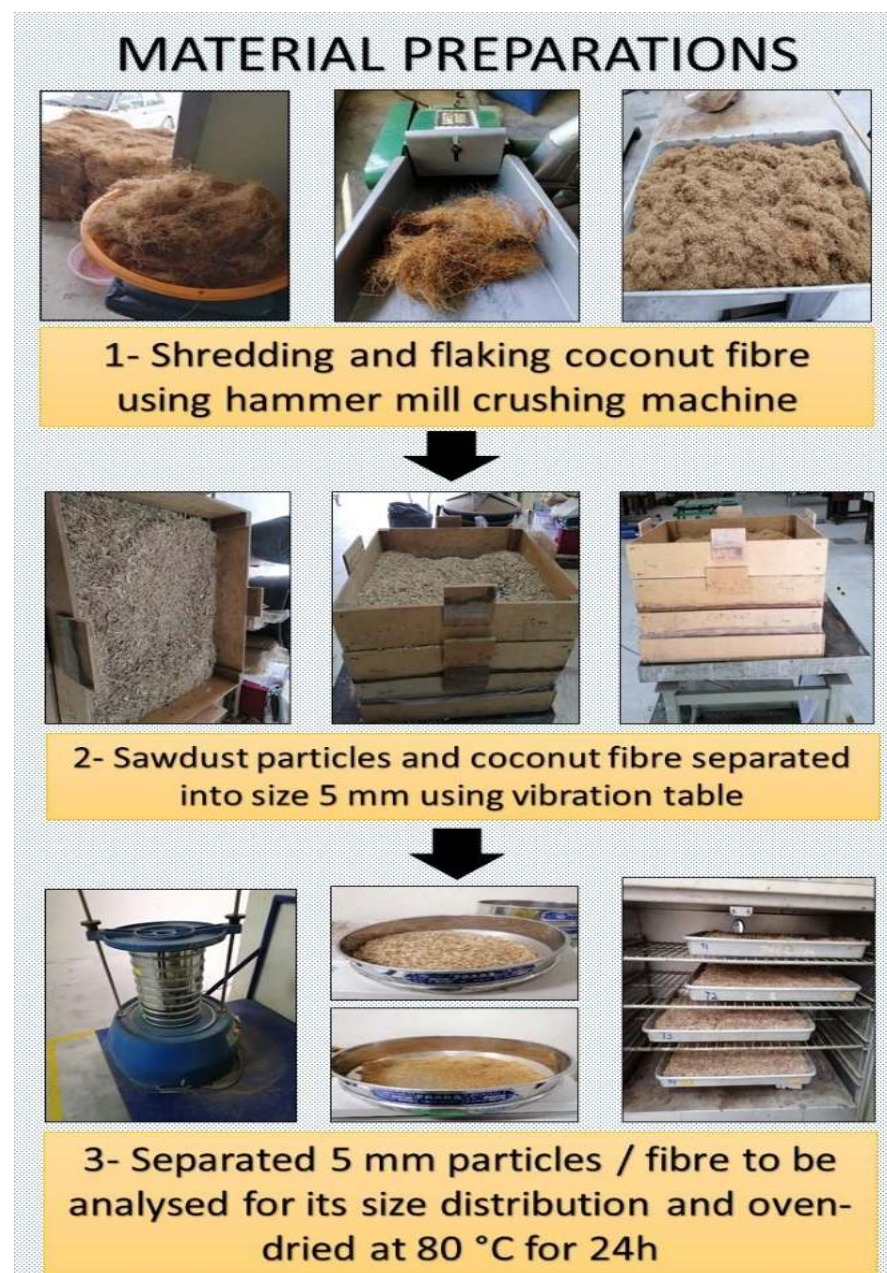

Figure 2. Sawdust Particle and Coconut Fibre Preparations.

Upon mixing process, sawdust, coconut fibre, and resin will be weighed to their respective percentage proportions and mixed together in a drum mixer for 10 min. The percentage proportion of sawdust and coconut fibre is designed dependent on the targeted density. The experimental boards were designed to have a density of 650 kg/m^3 , which is the typical density of particleboard made in industrial conditions from wood particles. UF resin was applied to the single-mat configuration at an 8 wt.% depending on particle weight. Section 2.3 Mix Design Calculation shows the calculation for determining the weight of sawdust, coconut fibre, and resin content.

Table 2 shows the fifteen different styles of boards that were made as shown Figure 3. The boards were created in the Timber Fabrication Laboratory at Universiti Tun Hussein Onn Malaysia using the hot press of hydraulic compression machine with plates measuring $450 \text{ mm} \times 450 \text{ mm}$. The particleboards were manually formed in wooden formwork at top and stainless-steel frames at bottom with dimensions of $350 \text{ mm} \times 350 \text{ mm} \times T \text{ mm}$, where T is the particleboard thickness. The particleboard thicknesses used in this study are

16 mm, 20 mm, and 32 mm. Boards measuring 350 mm × 350 mm were then hot-pressed for 7 min at 180 °C under 2.5 to 3.0 N/mm² strain. After pressing, the particleboards were conditioned for one week at 20 °C and 65% relative humidity before being evaluated physical and mechanical properties. To avoid edge defects, the particleboards were first trimmed to a final dimension of 300 mm × 300 × T mm. Each board type was used for 3 replication samples, and test pieces for mechanical and physical examination were cut from each particleboard sample. Physical properties such as swelling in thickness and water absorption both are tested under same condition by immersion of test pieces in water bath with room temperature for 24 h. The mechanical performance of particleboards, such as modulus of elasticity and modulus of rupture, in bending strength and internal bonding are tested by using same universal testing machine. Specifications, criteria, and results of particleboard panel sampling and testing will be addressed in compliance with the equivalent British Standard (BS) for particleboard specification.

2.2. Particle Size Distribution

Coconut fibre was sieved using a rectangle handmade wood sieve of 5 mm, 3 mm, 1 mm, and pan, as well as for sawdust on a vibration table. After that, sawdust and coconut fibre retained at 5 mm were separated for board making and the particle size analysis using vertical sieve shaker. Particle size distribution analysis for sawdust and coconut fibre respectively employed U.S. Standard Sieves–AASHTO M 92, which were then plotted into a S-curve, as shown in Figures 4 and 5. After the sieving process, it was found that both the sawdust and coconut fibre might not have sieved properly, so the S-curve in Figures 4 and 5 only can be used as benchmark to identify the size distribution of materials where the particle and fibre size are more than 2.36 mm, and where only sawdust particles and coconut fibre with size 5 mm are used in particle size distribution analysis after shaking using a vibration table at the beginning stage of material preparations. It is much more difficult, if not impossible, to achieve those optimum positions for flaky particles or longer rods or fibre [21].

Table 2. Design Mixed of Board Sample According to Respective Mass.

% Proportion of Mixed Design (%SD: %CF-Thickness Group(T))	Mass of Materials (g)		
	Sawdust Particles (SD)	Coconut Fibre (CF)	Resin
100SD:0CF-T16	1190.22	0	153.32
70SD:30CF-T16	833.15	357.07	153.32
50SD:50CF-T16	595.11	595.11	153.32
30SD:70CF-T16	357.07	833.15	153.32
0SD:100CF-T16	0	1190.22	153.32
100SD:0CF-T20	1487.77	0	191.65
70SD:30CF-T20	1041.44	446.33	191.65
50SD:50CF-T20	743.89	743.89	191.65
30SD:70CF-T20	446.33	1041.44	191.65
0SD:100CF-T20	0	1487.77	191.65
100SD:0CF-T32	1853.28	0	238.73
70SD:30CF-T32	1297.30	555.98	238.73
50SD:50CF-T32	926.64	926.64	238.73
30SD:70CF-T32	555.98	1297.30	238.73
0SD:100CF-T32	0	1853.28	238.73

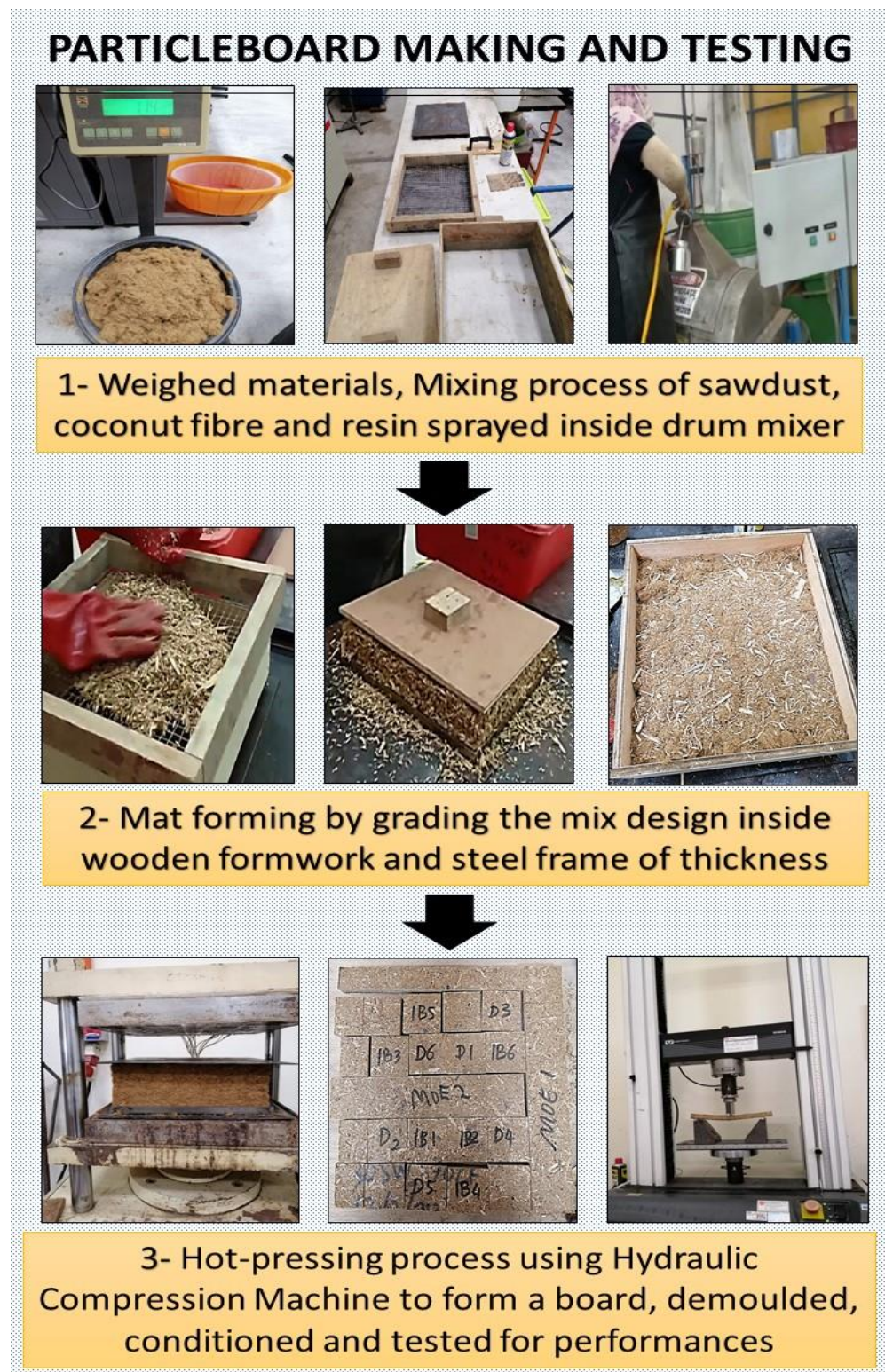

Figure 3. Particleboard Making Process and Testing.

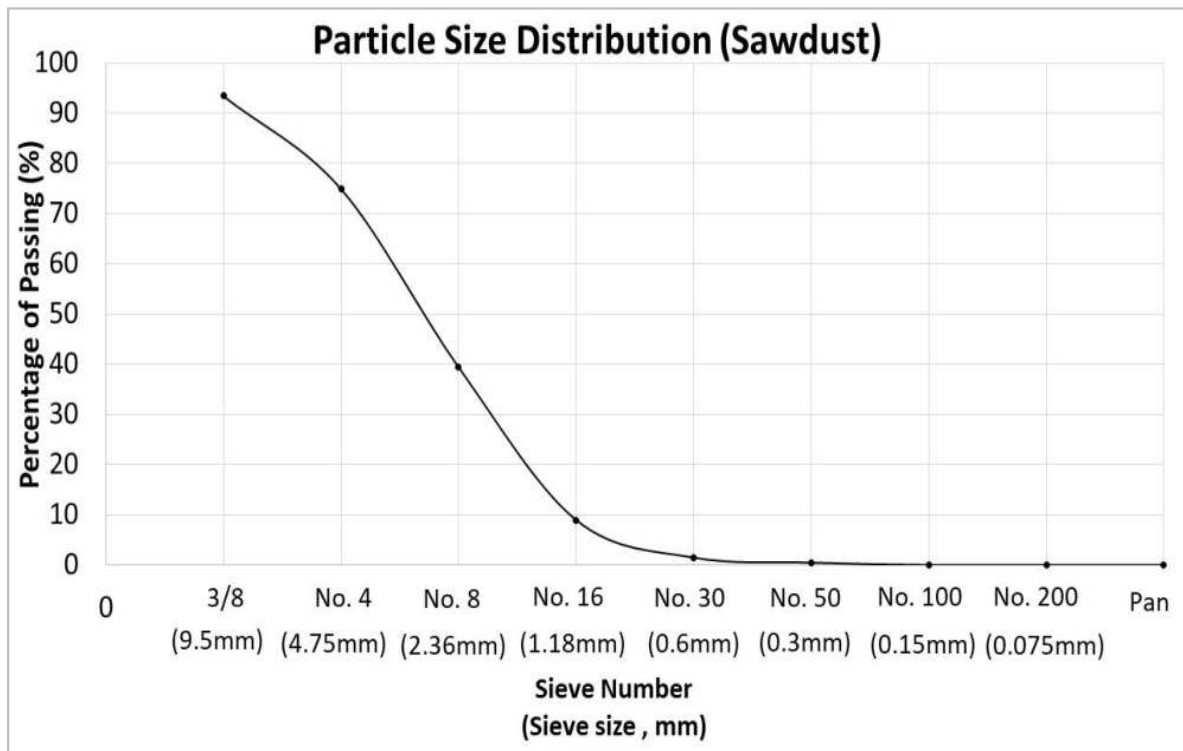

Figure 4. Particle Size Distribution for Sawdust Particle.

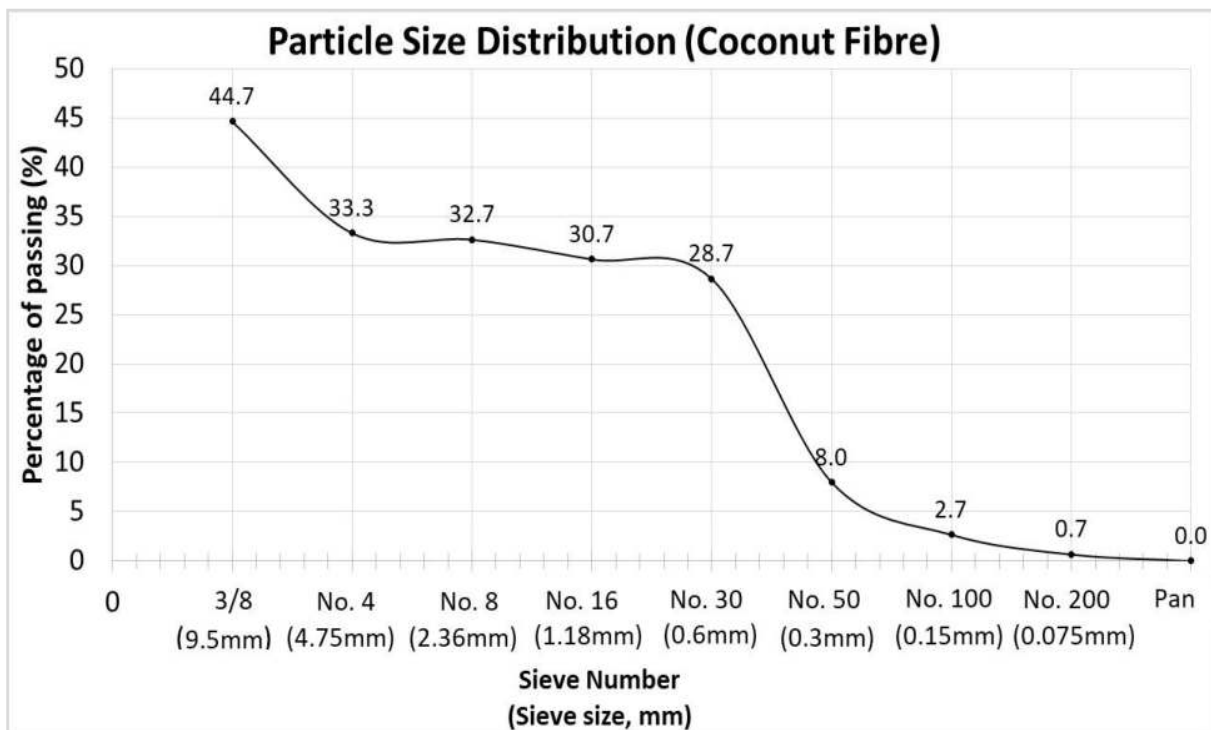

Figure 5. Particle Size Distribution for Coconut Fibre.

2.3. Mix Design Calculation

The design of percentage proportion of sawdust and coconut fibre are based of targeted density. The sample calculation [22] for the mixed design of hybrid fibre-particleboard are shown in steps 1–4 and each design mix is tabulated in Table 2.

(1) Determine the dimension of board sample

Board dimension (cm^3) = width \times length \times thickness. For example,
 Board dimension (cm^3) = 34 cm \times 34 cm \times 1.6 cm. Therefore,
 Board dimension (cm^3) = 1849.60 cm^3

(2) Determine the wet and dry mass of board

Targeted density = 0.65 g/ cm^3
 Wet mass (g) = Board Dimension \times Targeted Density
 Wet mass (g) = 0.65 g/ cm^3 \times 1849.60 cm^3
 Wet mass (g) = 1322.50 g
 Dry mass (g) = Moisture content (%) \times Wet Mass (g)
 Dry mass (g) = 10% \times 1322.50 g
 Dry mass (g) = 1190.20 g

(3) Determine mass of resin content

Solid resin content = 64.51% (given by supplier)
 Design resin content = 8%
 Mass of resin content = (Design resin content/Solid resin content) \times Dry mass \times wastage
 Mass of resin content = (8/64.51) \times 1190.20 g \times 5% (wastage)
 Mass of resin content = 153.32 g

(4) Determine mass of sawdust and coconut by percentage of proportion design

Let say,
 Percentage proportion of sawdust to coconut fibre = 70SD:30CF
 (70% sawdust to 30% coconut fibre)
 Mass of sawdust (g) = 70% \times (D)
 Mass of sawdust (g) = 70% \times 1190.20 g = 833.15 g
 Mass of coconut fibre (g) = 30% \times (D)
 Mass of coconut fibre (g) = 30% \times 1190.20 g = 357.07 g

2.4. To Determine a Suitable Mix Design of Waste by Relying on the Optimum Performance of Physical Properties and Mechanical Performances

2.4.1. Physical Properties of Boards

The test pieces of board sample were subjected to several tests to determine the physical properties and mechanical performance. Table 3 is the extracted values from BS EN 312-2010 [23] requirement for particleboards. All test pieces were compared to the values and the type of particleboard. Physical properties, such as thickness swelling, as well as mechanical performance on bending strength and tensile strength, are shown according to thickness group in this study. However, the benchmark for this study is non loading board for use in humid conditions, Type P3.

Table 3. Requirement Values for Type P3 Board (extracted from BS EN 312-2010).

Board Type	Thickness	Bending Strength (N/mm ²)	Modulus of Elasticity in Bending—MOE (N/mm ²)	Internal Bonding (N/mm ²)	Thickness Swelling (%)
Non load-bearing boards for use in humid conditions-P3	>13–20 mm	14	1950	0.45	14
	>20–25 mm	12	1850	0.4	13
	>25–32 mm	11	1700	0.35	13

Determination of Density (BS EN 323: 1993) and Swelling in Thickness after Immersion in Water (BS EN 317:1993)

In accordance to BS EN 323: 1993 [24], the test pieces must be square in shape, with sides of a nominal length of 50 mm, and must be sampled and cut in compliance with EN 326-1, as shown in Figure 6a and selection of test pieces from board sample as shown in Figure 6b. Micrometre or equivalent measuring instrument with smooth and parallel circular measuring surfaces of (16 ± 1) mm diameter and a force of action of (4 ± 1) N. The apparatus's graduation must make readings down to 0.01 mm. Each test piece is weighed with a precision of 0.01 g. In conjunction with EN 325, the dimensions of each test object are measured as shown in Figure 7a–c. The thickness, t , is measured to a precision of 0.05 mm at the point of intersection of the diagonals shown in Figure 6a (unless this coincides with a surface irregularity that may affect the measurement). Slowly apply the measuring tool to the measurement piece's surfaces. To a precision of 0.1 mm, measure b_1 and b_2 at two points parallel to the edges of the test object, along lines that move through the centres of opposite edges. The density of a board is calculated by taking the integer mean of the densities of all test pieces taken from the same board and is expressed in kg/m³ to three significant figures. The density ρ of each test piece (in kg/m³) shall be calculated from Equation (1).

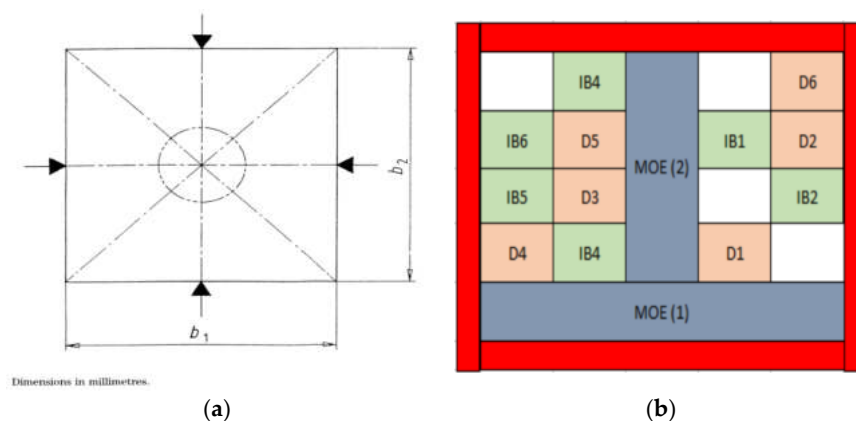
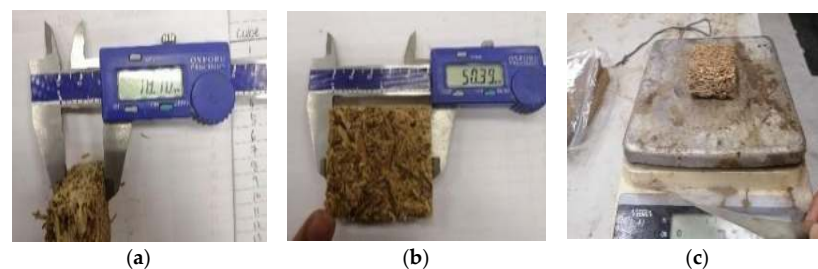
**Figure 6.** (a) Point of Measurement; (b) Test piece chosen from a sample board.**Figure 7.** Each specimen being measured for its (a) thickness; (b) area; and (c) weight to determine the density of particleboard determination of swelling in thickness after immersion in water (BS EN 317:1993).

Equation (1). Determination of Density of Boards

$$\rho = \frac{m}{b_1 \times b_2 \times t} \times 10^6 \quad (1)$$

where m is the mass of board, in gram, b_1 , b_2 is the dimension of board, in millimetre, and t is the thickness of board, in millimeter.

In accordance with BS EN 317: 1993 [25], the thickness of each test piece must be determined to a precision of 0.01 mm at the intersection of the diagonals (Figure 8). Immerse the test pieces, faces up, in clear, still water with a pH of 7 ± 1 and a temperature of $(20 \pm 1)^\circ\text{C}$. This temperature must be preserved during the duration of the test. During the test, the test pieces must be kept apart from one another as well as from the bottom and sides of the water bath. Throughout the procedure, the upper edges of the test pieces must be surrounded by (25 ± 5) mm of water. After each test, the water must be changed. The immersion times must be as defined by the individual criteria for each board type.

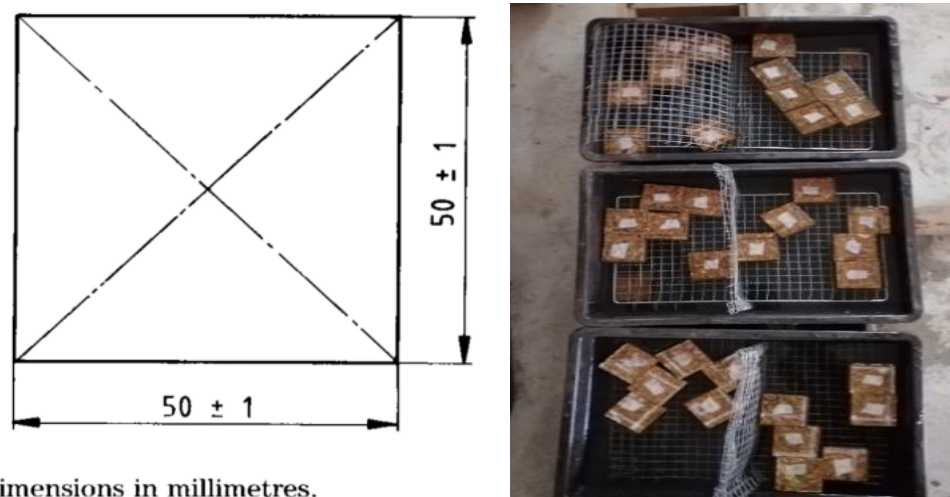

Dimensions in millimetres.

Figure 8. Test piece for the measurement and Test pieces immersed in water for 24 h.

After the immersion period has passed, withdraw the test pieces from the bath, shake off any extra water, and measure the thickness of each test piece. The swelling in thickness of each test piece, G_t , expressed as a percentage of initial thickness, must be measured using the Equation (2) below. The swelling in thickness of a board is the arithmetic mean of all test pieces taken from that board and is expressed in percentage, to one decimal. The same equation can be used to calculate the water absorption of a board, where t_1 and t_2 are the mass of the test piece before immersion and the mass of the test piece after immersion in gram (g).

Equation (2). Determination of thickness swelling

$$G_t = \frac{t_2 - t_1}{t_1} \times 100 \quad (2)$$

where t_1 is the thickness of the test piece before immersion, in millimetres and t_2 is the thickness of the test piece after immersion, in millimetres.

2.4.2. Mechanical Performances of Boards

Determination of Particleboard's Modulus of Elasticity and Modulus of Rupture (BS EN 310:1993)

Every test piece's diameter and thickness should be measured in accordance with EN 325 at the following points: the thickness at the diagonal intersection; the width at mid-length. Meanwhile, the width and thickness of test pieces are 50 mm and as defined in

thickness group (16 mm, 20 mm, and 32 mm). Adjust the distance between the support centres to within 1 mm of 20 times the nominal thickness of the material, but not less than 100 mm or more than 1000 mm. In this study, the distance is set at 200 mm. To the nearest 0.5 mm, measure the distance between the centres of the supports. Place the test piece flat on the supports, with its longitudinal axis at right angles to those of the supports with the centre point under the load (Figures 9 and 10). The load shall be applied at a constant rate of cross-head movement throughout the test.

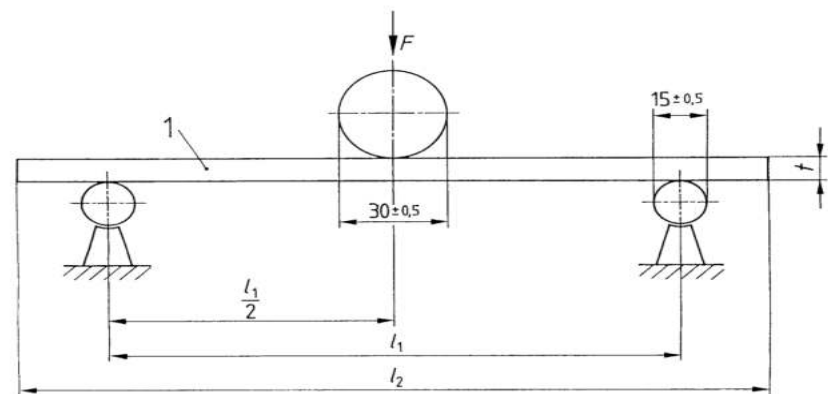

1 = test piece
 F = load
 t = thickness of the test piece
 $l_1 = 20 t$
 $l_2 = l_1 + 50$
 Dimensions in millimetres.

(a)

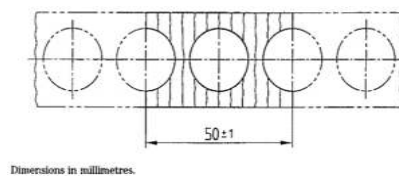

Dimensions in millimetres.

(b)

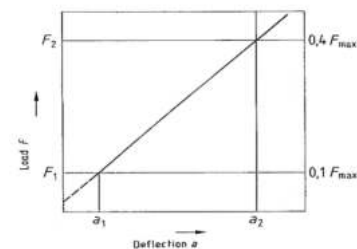

(c)

Figure 9. (a) Arrangement of the bending apparatus, (b) Cross section of tubular boards, (c) Load-deflection curve within the range of elastic deformation.



(a)

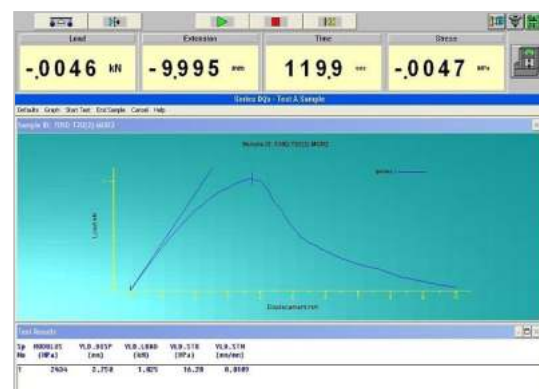

(b)

Figure 10. Mechanical properties for each particleboard determined by (a) the specimen tested using Universal Testing Machine; (b) after failure, the graph and value for Modulus of Elasticity (MOE) and Modulus of Rupture (MOR) appeared on screen.

The loading rate must be adjusted such that the maximum load is achieved in (60 ± 30) s. Measure the deflection in the centre of the test piece (below the loading head) to an accuracy of 0.1 mm and map these values against the equivalent loads estimated to an accuracy of 1% of the measured volume. If incremental readings are used to calculate deflection, at least 6 pairs of readings must be used. Record the full load with a precision of 1% of the calculated value. Test two sets of test pieces in each of the board's two directions, i.e., in the longitudinal and transverse directions. Check half of the test pieces of each group with the "top face" upwards and half with the "bottom face" upwards. The modulus of elasticity, E_m (in N/mm^2), of each test piece shall be expressed to three significant figures, calculated from Equation (3) [26].

Equation (3). Determination of Modulus of Elasticity of Board

$$E_m = \frac{(l_1)^3 (F_2 - F_1)}{4 b t^3 (a_2 - a_1)} \quad (3)$$

where,

l_1 is the distance between the centres of the supports, in millimetres;

b is the width of the test piece, in millimetres;

t is the thickness of the test piece, in millimetres;

$F_2 - F_1$ is the increment of load on the straight-line portion of the load-deflection curve Figure 9c in N. F_1 shall be approximately 10% and F_2 shall be approximately 40% of the maximum load;

$a_2 - a_1$ is the increment of deflection at the mid-length of the test piece (corresponding to $F_2 - F_1$).

The bending strength of each test piece shall be expressed to three significant figures. The bending strength for each group of test pieces taken from the same board is the arithmetic mean of the bending strengths of the appropriate test pieces, expressed to three significant figures. The bending strength f_m (in N/mm^2), of each test piece, is calculated from the Equation (4) [26].

Equation (4). Determination of Bending Strength (Modulus of Rupture) of Boards

$$f_m = \frac{3 E_{max} l_1}{2 b t^2} \quad (4)$$

where,

F_{max} is the maximum load, in Newtons;

l_1 , b , and t are in millimetres;

Determination of Tensile Strength Perpendicular to the Plane of the Board or Internal Bonding (BS 319:1993)

The test pieces must be square and have a side length of (50 ± 1) mm. The test pieces must be precisely cut, the angles must be 90° , and the edges must be smooth and clean. As seen in Figures 11 and 12, each test piece must be bound to the loading blocks with a suitable adhesive. Excess glue that has been pressed away from the glue line must be cleaned. If hot-melt glue is used, the screen side of hardboards must be sanded to create a smooth finish. If the panel side cannot be sanded, a gap-filling glue (epoxy glue) must be used. Additional pressures affecting the test piece caused by the moisture in the adhesive and the increase in temperature, for example, should be followed to prevent when glueing. The experiments must not be performed until the adhesive has had enough time to recover so that the rupture does not occur in the glueline and the test pieces can recover an equal distribution of moisture.

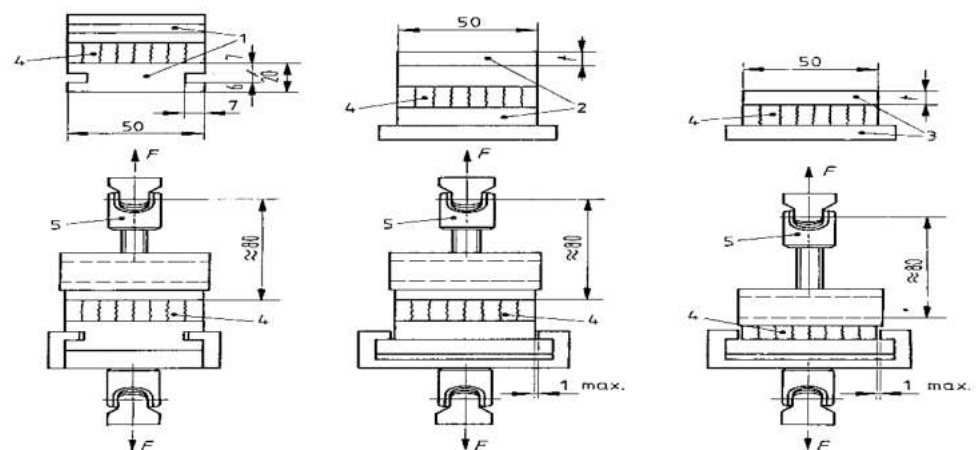

Figure 11. Examples of apparatus for testing tensile strength perpendicular.

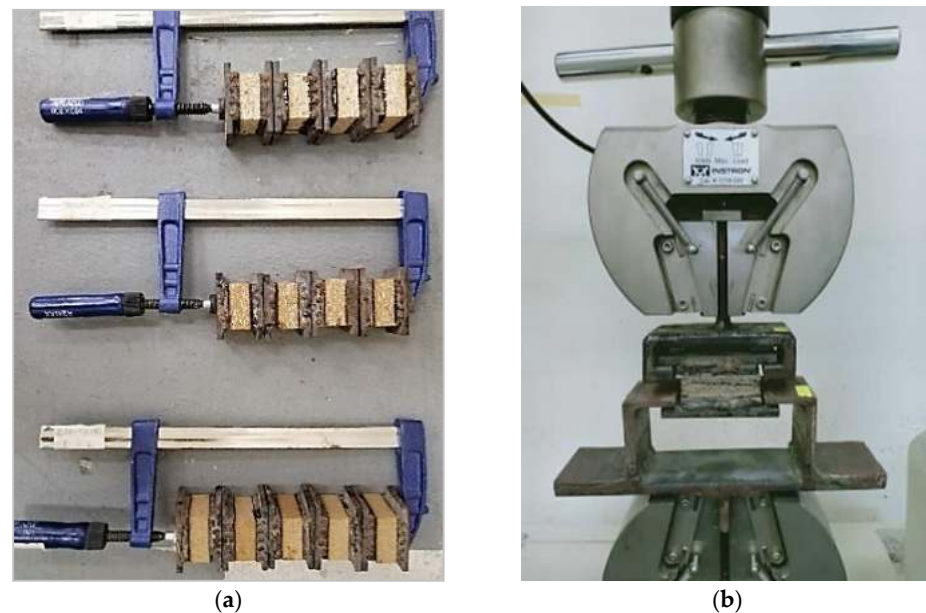

Figure 12. Tensile Strength Perpendicular to Plane of Board; (a) Test pieces glued to metal plate and dried for 24 h, (b) The arrangement of apparatus during laboratory testing.

In addition, if hot-melt or epoxy glues are used 24 h is adequate, and 72 h if other glues are used. During this time, the glued assembly must be held under controlled conditions of $(65 \pm 5)\%$ relative humidity and $(20 \pm 2)^\circ\text{C}$ temperature. Test pieces must be checked within 1 h of being removed from the conditioning environment. Place the testing assembly in the grips and apply force until the assembly ruptures. Throughout the test, the load should be applied at a steady rate of crosshead movement. The loading rate should be adjusted such that the maximum load is achieved in (60 ± 30) seconds. Tensile strength perpendicular to the plane of the board of each test piece, $f_{t\perp}$, expressed in N/mm^2 to two decimals, is calculated according to Equation (5) [27].

Equation (5). Determination of Tensile Strength Perpendicular to the Plane of Board (Internal Bonding)

$$f_{t\perp} = \frac{F_{max}}{a \times b} \quad (5)$$

where,

F_{max} is the breaking load, in Newtons;

a, b is the length and width of the test piece, in millimetres.

3. Results and Discussion

3.1. Physical Properties of Particleboards

Table 4 shows example on details on test pieces to determine density, thickness swelling and water absorption for board 100SD:0CF in thickness group 16 mm. Figure 13 shows all test results on test pieces are from three samples of each type of board from the summary shown in Table 5.

Table 4. Details of Test Pieces to Determine Density, Thickness Swelling and Water Absorption for Board 100SD:0CF in Thickness Group 16mm.

Cube No	Width, b1 (mm)	Length, b2 (mm)	Area (mm ²)	Thick- Ness (mm)	Volume (mm ³)	Mass (g)	Density (kg/m ³)	Thickness Swelling		Water Absorption	
								TS (24HR), mm	% TS (24HR)	WA (24HR), g	% WA (24HR)
D1	51.15	50.72	2594.328	16.10	41768.681	33	790.07	23.39	31.17	62	46.77
D2	49.11	50.61	2485.457	16.15	40140.132	30	747.38	23.16	30.27	57	47.37
D3	50.67	53.58	2714.899	16.11	43737.016	32	731.65	23.15	30.41	63	49.21
D4	54.01	50.7	2738.307	16.27	44552.255	26	583.58	21.34	23.76	56	53.57
D5	49.99	50.64	2531.494	15.92	40301.378	31	769.20	22.29	28.58	59	47.46
D6	51.37	50.64	2601.377	16.31	42428.456	28	659.93	22.27	26.76	57	50.88
D7	48.07	50.75	2439.553	16.15	39398.773	28	710.68	22.22	27.32	54	48.15
D8	49.96	50.57	2526.477	16.03	40499.430	30	740.75	23.2	30.91	59	49.15
D9	50.9	51.91	2642.219	16.09	42513.304	30	705.66	21.84	26.33	59	49.15
D10	48.75	50.93	2482.838	16.25	40346.109	27	669.21	21.7	25.12	53	49.06
D11	48.98	50.56	2476.429	16.12	39920.032	30	751.50	22.45	28.20	56	46.43
D12	50.85	49.13	2498.261	15.94	39822.272	28	703.12	23.71	32.77	57	50.88
Average				16.12			713.56		28.46		49.01

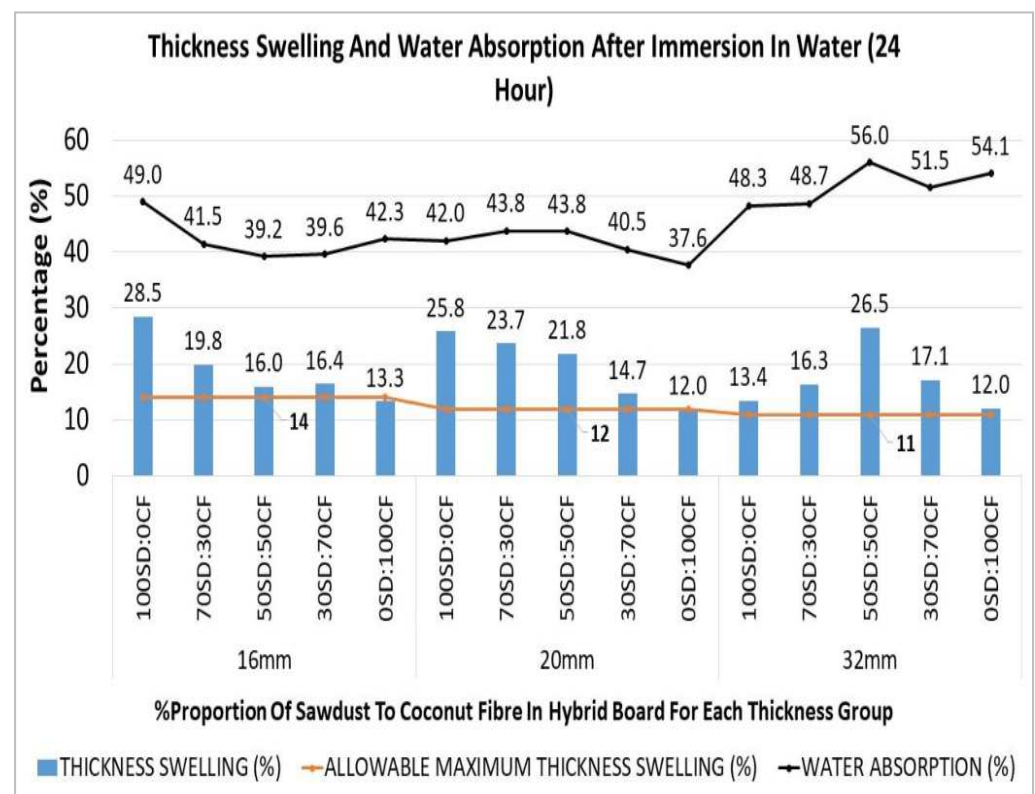

Figure 13. Thickness Swelling and Water Absorption after Immersion in Water (24 h).

Table 5. Summary on Density, Thickness Swelling and Water Absorption of Test Pieces of All Boards.

Proportion (%SD: %CF)	Thickness Group (mm)	Average Thickness (mm)	Average Density (kg/m ³)	Average Thickness Swelling (%)	Average Water Absorption (%)
100SD:0CF	16	16.12	713.56	28.46	49.01
70SD:30CF		16.43	743.00	19.82	41.48
50SD:50CF		16.22	752.30	15.98	39.19
30SD:70CF		16.23	769.70	16.41	39.57
0SD:100CF		16.48	731.77	13.28	42.31
100SD:0CF	20	19.28	743.76	25.80	42.04
70SD:30CF		19.54	778.38	23.70	43.79
50SD:50CF		19.32	758.54	21.81	43.76
30SD:70CF		19.57	747.21	14.73	40.51
0SD:100CF		19.57	761.99	11.98	37.64
100SD:0CF	32	34.12	573.23	13.44	48.31
70SD:30CF		33.51	595.74	16.33	48.69
50SD:50CF		36.22	592.94	26.48	55.99
30SD:70CF		33.97	595.67	17.10	51.51
0SD:100CF		35.18	551.43	12.02	54.06

3.1.1. Density of Particleboards

The density distribution in particleboard is the mean from the test pieces. The density designed for the hybrid fibre-particleboard is 650 kg/m³. For boards in thickness group of 16 mm, the average density obtained is 742.067 kg/m³ which is 14.16% higher than the designed density. Meanwhile, for boards in thickness group of 20 mm, the average density obtained is 757.977 kg/m³ which is 16.61% higher than the designed density. At last, for boards in thickness group of 32 mm, the average density obtained is 581.801 kg/m³ which is 10.49% lower than the designed density. It is concluded that the density of boards decreased as the thickness of boards increased. However, all boards in all thickness groups are comparative to the density of commercial particleboard, ranging from 580 to 810 kg/m³.

3.1.2. Swelling in Thickness and Water Absorption

The test pieces were immersed in water for 24 h before testing for swelling in thickness and water absorption. As specified in BS EN 312:1993, the allowable maximum thickness swelling for thickness group 16 mm is lower than or equal to 14%, for thickness group 20 mm it is lower than or equal to 12%, and for thickness group 32 mm it is lower or equal to 11%. Firstly, for thickness group 16 mm, only board 0SD:100CF achieved 13.3% thickness swelling which is lower than 14%. Other boards in the same thickness group achieved more than 14% thickness swelling, between 16% to 28.5%. After that, for thickness group 20 mm, only board 0SD:100CF achieved 12% thickness swelling which is equal to allowable thickness swelling of 12%. Meanwhile, other boards in the same thickness group achieved more than 12% thickness swelling, which are between 14.7% to 25.8%. Lastly, for thickness group 32 mm, all boards achieved more than allowable thickness swelling, ranging from 12% to 26.5%. From Figure 13, it is concluded that the greater the content of coconut fibre in hybrid fibre particleboard, the lower the swelling in thickness for all boards in all thickness group.

The water absorption for all boards in all thickness group range between 37.6% to 56%. Whereas, the lowest values obtained by board 0SD:100CF in group thickness 20 mm and the highest values obtained by board 50SD:50CF in group thickness 32 mm. For thickness group 16 mm, as the content of coconut fibre increased in proportion, the water absorption decreased, however, as the coconut fibre replaced 70% to 100% of sawdust in proportion, the water absorption slightly increased. For thickness group 20 mm, as

the content of coconut fibre increased in proportion, the water absorption decreased. For thickness group 32 mm, as the content of coconut fibre increased in proportion, the water absorption also increased. Therefore, the content of coconut fibre in proportion of board might have affected the physical changes of boards.

3.2. Mechanical Performance of Particleboards after Strength Test

3.2.1. Modulus Elasticity (MOE)

Figure 14 presents a curve of load versus deflection of test pieces for board 100SD:0CF in thickness group 16 mm and plotted during the determination of modulus of elasticity in bending and of bending strength using a universal testing machine (UTM). Two (2) board samples with two (2) test pieces in transverse and longitudinal section each are tested. The maximum loads for test piece of board sample no 1 in transverse and longitudinal section are 0.4083 kN and 0.5203 kN, respectively, with differences of 21%, and deflection is 2.5 mm at the centre of both test pieces. Meanwhile, for the test piece of board no 2, in transverse and longitudinal section, such loads are 0.4938 kN and 0.6947 kN, respectively, with difference of 29% and deflection is 3.67 mm to 3.75 mm at the centre of test piece. Therefore, on average, the maximum load on board 100SD:0CF with thickness group 16 mm is 0.5293 kN.

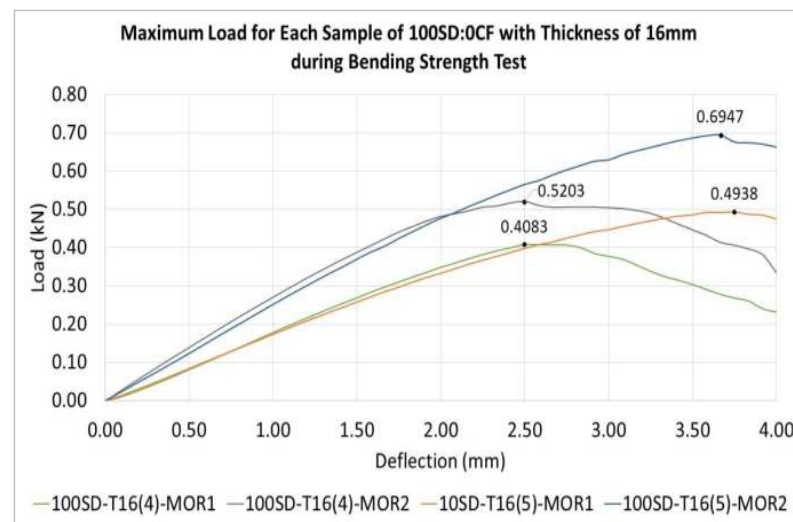

Figure 14. Load Against Deflection in Bending Test for Board 100SD:0CF in Thickness Group 16 mm.

According to Figure 15, the maximum load ranging from the lowest of 390 N to the highest of 1911 N. The lowest maximum load was achieved by board 50SD:50CF in thickness group of 16 mm and the highest maximum load was achieved by board of 70SD:30CF in thickness group of 32 mm. In the thickness group of 16 mm, the highest maximum load of 802 N was achieved by board 0SD:100CF, followed by 30SD:70CF with maximum load of 775 N and 70SD:30CF, 100SD:0CF, and 50SD:50CF with maximum loads of 560 N, 408 N, and 390 N, respectively.

On other hand, for boards in thickness group of 20 mm, the maximum load increased as the proportion of coconut fibre increased, whereas board 100SD:0CF with 983 N maximum load, 70SD:30CF with maximum load of 1025 N, board 50SD:50CF with maximum load of 1078 N, board 30SD:70CF with maximum load of 1356 N, and 0SD:100CF with 1298 N maximum load. After that, all boards in thickness group of 32 mm achieved maximum load over 1230 N before failure. Board 100SD:0CF achieved 1230 N maximum load, board 70SD:30CF achieved 1410 N maximum load, while the maximum load for board 30SD:70CF with 1911 N declined to 1750 N by board 0SD:100CF.

The trend of maximum load achieved before failure for boards in thickness group of 20 mm and 32 mm almost the same whereas the sawdust proportion decreased and replaced by coconut fibre at 30% to 70% the maximum load increased but decreased

when the coconut fibre proportion increased by replacing sawdust at 100%. However, the trend for the thickness group of 16 mm is different because, as the sawdust proportion decreased and was replaced by coconut fibre 30–50%, the maximum load decreased and increased again as the coconut fibre replaced sawdust at 70% and 100%. Therefore, it can be concluded that boards with 70% coconut fibre replacing sawdust in proportion with increasing thickness can achieved highest maximum loads before failure.

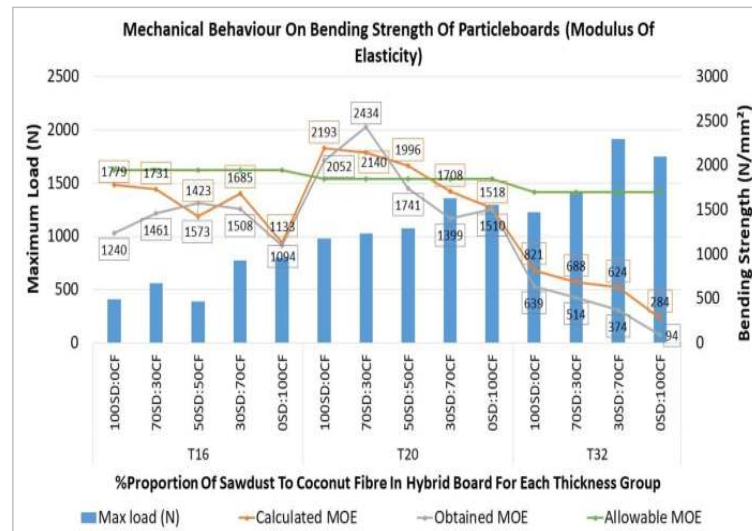

Figure 15. Mechanical Performances on Bending Strength of Particleboards (Modulus of Elasticity).

As for modulus of elasticity (MOE), the bending strength of hybrid fibre-particleboards will be compared between obtained values and calculated values. Firstly, for boards in thickness group of 16 mm, the MOE increased as the proportion of sawdust decreased, with the coconut fibre replacing sawdust for 30% and 50%, but decreased as the proportion of coconut fibre was 70% and 100% for obtained values. However, the trend is reversed for calculated values. For the obtained value, MOE for board 100SD:0CF is 1240 N/mm² while the calculated value is 1779.33 N/mm². Therefore, the differences between obtained and calculated values is 30%. For board 70SD:30CF the MOE obtained value is 1461 N/mm² which is 16% lower than calculated value of 1730.92 N/mm², board 50SD:50CF the MOE obtained value is 1573 N/mm² which is 9.5% higher than the calculated value of 1423.33 N/mm². Meanwhile, for board 30SD:70CF and 0SD:100CF, the MOE obtained values are 1508 MPa and 1094 MPa, which are 10.5% and 3.4% lower than calculated values of 1685.38 N/mm² and 1133.45 N/mm², respectively. All boards in this thickness group do not meet the requirement of 1950 N/mm² for Type P3 particleboards use in humid condition for both obtained and calculated values.

Secondly, for boards in thickness of 20 mm the MOE calculated value is decreased as the sawdust proportion is decreased, but the MOE obtained value slightly increased when sawdust proportion decreased from 100% to 70% however when as the coconut fibre proportion increased from 50% to 70% the obtained value decreased and increased back when the sawdust proportion reduced and replaced by 100% coconut fibre. As a comparison between obtained values to calculated values of MOE, board 100SD:0CF with obtained value of 2052 N/mm² is 6.4% lower than the calculated value of 2193.34 N/mm², whereas both values meet the requirement of 1850 N/mm². For board 70SD:30CF, the MOE obtained value is 2434 N/mm², which is 12% higher than calculated value of 2140.28 N/mm² and both passed the requirement. For board 50SD:50CF, the MOE obtained value is 1741 N/mm², which is 12.8% lower than calculated value of 1995.98 N/mm², where only the calculated value passed the requirement. Meanwhile, for board 30SD:70CF and 0SD:100CF, the MOE obtained values are 1399 N/mm² and 1510 N/mm², which are 14.2% and 0.5% lower than calculated values of 1707.88 N/mm² and 1517.65 N/mm², respectively.

Lastly, for boards in thickness group of 32 mm, the MOE decreased as the proportion of sawdust decreased for both obtained values and calculated values. For obtained value, board 100SD:0CF obtained value is 639 N/mm² while calculated value is 821.36 N/mm² with differences of 22%. For board 70SD:30CF the MOE obtained value is 513.8 N/mm² which is 25% lower than calculated value of 688.11 N/mm². Meanwhile, for board 30SD:70CF and 0SD:100CF, the MOE obtained values are 374.4 N/mm² and 93.730 N/mm², which are 40% and 67% lower than calculated values of 624.37 N/mm² and 283.86 N/mm², respectively. All boards do not pass the requirement of 1700 N/mm² for both obtained and calculated values.

3.2.2. Modulus of Rupture (MOR)

Figure 16 shows that for board in thickness group 16 mm where the Modulus of Rupture (MOR) decreased as the sawdust proportion decreased from 100SD:0CF to 70SD:30CF which is 11.87 N/mm² and 10.01 N/mm² respectively. However, when the sawdust proportion decreased from 50SD:50CF to 70SD:30CF, the MOR increased to 10.47 N/mm² and 13.48 N/mm², respectively, and dropped again when sawdust was replaced with 100% coconut fibre in board 0SD:100CF with a value of 12.79 N/mm². All boards in thickness group 16 mm do not pass the requirement of 14 N/mm². For boards in thickness group 20 mm, all boards pass the requirement of 12 N/mm². Namely, boards 100SD:0CF, 70SD:30CF, 50SD:50CF, 30SD:70CF, and 0SD:100CF obtained the MOR value of 14.33 N/mm², 14.04 N/mm², 14.76 N/mm², 15.05 N/mm², and 17.8 N/mm², respectively, whereas the increasing the coconut fibre proportion the highest MOR obtained. Lastly, for boards in thickness group 32 mm, all boards do not pass the requirement of 12 N/mm². Namely, board 100SD:0CF, 70SD:30CF, 30SD:70CF, and 0SD:100CF obtained the MOR value of 7.45 N/mm², 7.57 N/mm², 7.56 N/mm², and 8.49 N/mm², respectively, whereas increasing the coconut fibre proportion, the highest MOR was obtained. Therefore, only boards in thickness group 20 mm performed as Type P3.

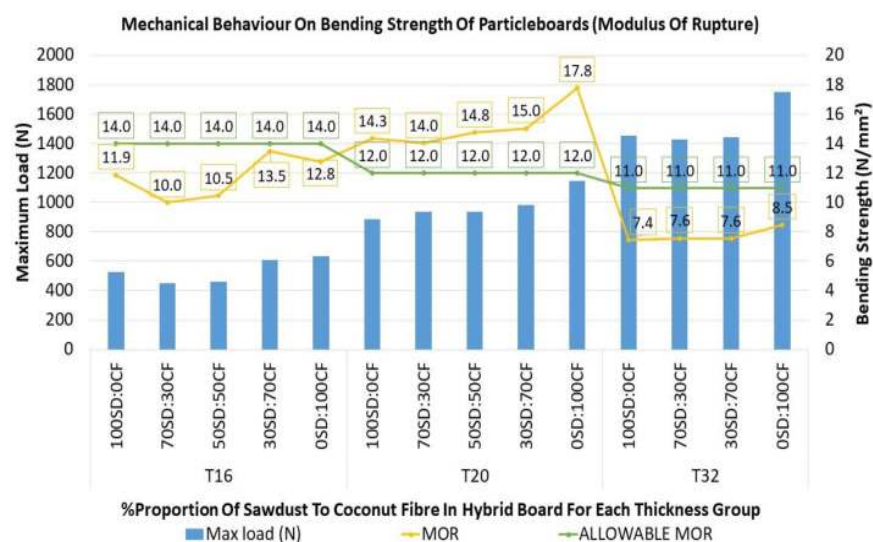

Figure 16. Mechanical Performances on the Bending Strength of Particleboards (Modulus of Rupture).

3.2.3. Internal Bonding

Table 6 show the results on performance of internal bonding after failure. Only test pieces from boards in thickness groups 16 mm and 20 mm are tested in comparison because, in terms of physical properties and mechanical performance on bending strength, only boards in thickness 20 mm meet most requirements for particleboard in Type P3. Each test piece is randomly chosen from the sample in each thickness group and summarised to determine the mean value of internal bonding.

Table 6. Results on Internal Bonding of Boards.

Group	Proportion SD:CF	Width, a (mm)	Length, b (mm)	Area, a × b (mm ²)	F max (kN)	Internal Bonding, N/mm ² > 0.35 (P3)
100SD:0CF-T16	100SD-T16(4(1))	50.16	50.93	2554.65	2.47	0.97
	100SD-T16(4(1))	52.8	50.91	2688.05	2.05	0.76
	100SD-T16(4(1))	49.59	50.94	2526.11	1.50	0.59
	100SD-T16(4(1))	50.27	50.85	2556.23	1.38	0.54
	Average			2581.26	1.85	0.72
70SD:30CF-T16	70SD-T16(3(1))	50.38	50.16	2527.06	1.41	0.56
	70SD-T16(3(3))	51.98	50.5	2624.99	1.48	0.57
	70SD-T16(5(1))	51.43	50.5	2597.22	1.18	0.46
	70SD-T16(5(3))	53.68	50.32	2701.18	1.36	0.50
	Average			2612.61	1.36	0.52
30SD:70CF-T16	30SD-T16(1(1))	50.21	50.99	2560.21	1.52	0.60
	30SD-T16(1(3))	50.88	51.04	2596.92	1.91	0.74
	30SD-T16(6(1))	50.03	51	2551.53	2.06	0.81
	30SD-T16(6(3))	50.95	49.65	2529.67	1.55	0.61
	Average			2559.58	1.76	0.69
0SD:100CF-T16	0SD-T16(2(1))	51.11	50.66	2589.23	2.11	0.82
	0SD-T16(2(3))	50.26	50.79	2552.71	1.96	0.77
	0SD-T16(6(1))	50.52	50.75	2563.89	1.65	0.64
	0SD-T16(6(3))	50.12	50.81	2546.60	1.69	0.66
	Average			2563.11	1.85	0.72
100SD:0CF-T20	100SD-T20(6(1))	54.29	55.21	2997.35	2.37	0.79
	100SD-T20(6(3))	52.56	54.49	2863.99	2.97	1.04
	100SD-T20(5(2))	48.43	53.39	2585.68	2.45	0.95
	100SD-T20(5(4))	53.25	49.37	2628.95	0.93	0.35
	Average			2768.99	2.18	0.78
70SD:30CF-T20	70SD-T20(3(1))	51	50.23	2561.73	1.55	0.61
	70SD-T20(3(3))	50.15	50.68	2541.60	1.95	0.77
	70SD-T20(2(1))	50.14	50.89	2551.62	2.41	0.94
	70SD-T20(2(3))	47.86	50.81	2431.77	0.87	0.36
	Average			2521.68	2.18	0.67
50SD:50CF-T20	50SD-T20(3(1))	50.55	50.96	2576.03	1.69	0.66
	50SD-T20(3(3))	50.13	50.75	2544.10	1.77	0.70
	50SD-T20(2(1))	52.57	50.79	2670.03	2.32	0.87
	50SD-T20(2(3))	48.22	50.86	2452.47	1.58	0.64
	Average			2560.66	1.84	0.72
30SD:70CF-T20	30SD-T20(1(1))	51.69	51.84	2679.61	2.77	1.03
	30SD-T20(1(3))	51.93	50.9	2643.24	2.14	0.81
	30SD-T20(3(1))	51.33	51.57	2647.09	1.51	0.57
	30SD-T20(3(3))	50.43	51.51	2597.65	1.57	0.60
	Average			2641.90	2.00	0.75
0SD:100CF-T20	0SD-T20(5(3))	53.03	54.09	2868.39	2.40	0.84
	0SD-T20(5(4))	49.1	51.09	2508.52	2.47	0.98
	0SD-T20(4(3))	53.29	49.65	2645.85	2.84	1.07
	0SD-T20(4(5))	52.99	48.05	2546.17	2.72	1.07
	0SD-T20(4(2))	54.97	47.57	2614.92	3.79	1.45
Average			2636.77	2.84	1.08	

Figure 17 shows the crack of test pieces after failure for tensile strength (internal bonding). All the cracks occurred in the middle cross-section of test pieces. The results obtained must be correlated to the occurrence of crack. If the crack is near to the glueline or steel plate, the result for that test piece will be a rejection in order to maintain the accuracy of results to be analysed.



Figure 17. The crack of test pieces after failure for tensile strength.

Figure 18 shows the tensile strength perpendicular to the plane of the board or internal bonding. The required values for internal bonding for thickness group 16 mm and 20 mm are 0.45 N/mm² and 0.40 N/mm² respectively. For boards in thickness group of 16 mm, board 100SD:0CF obtained 0.54 N/mm² which is 16.5% higher than required. Board 70SD:30CF the internal bonding slightly lower than board 100SD:0CF which is 0.52 N/mm², 13.7% lower than 0.45 N/mm², and the internal bonding increased as the coconut fibre proportion increased in board 30SD:70CF and 0SD:100CF, where the obtained values are 0.69 N/mm² and 0.72 N/mm² respectively. All boards in thickness group 16 mm surpass the requirement for Type P3.

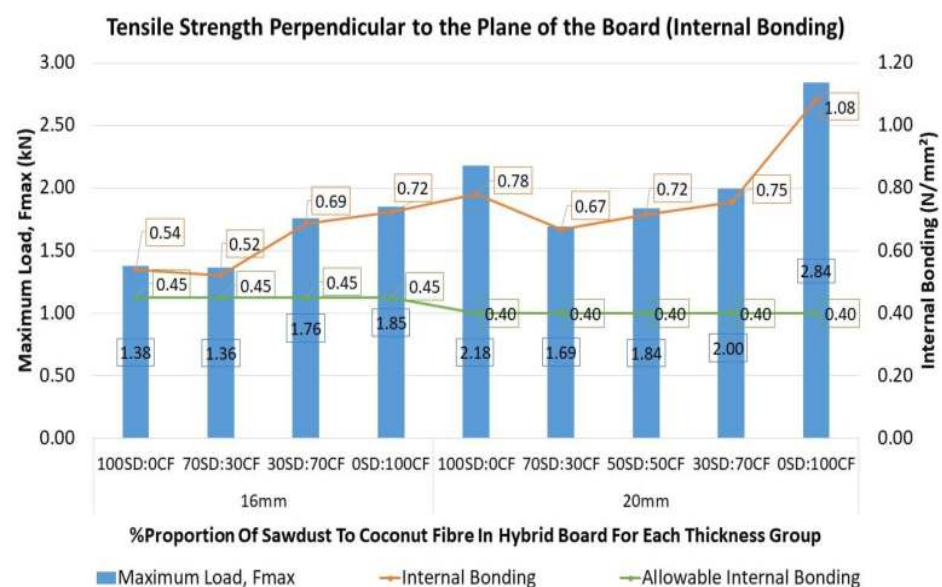

Figure 18. Tensile Strength Perpendicular to the Plane of the Board (Internal Bonding).

For boards in thickness 20 mm, the trendline for internal bonding was the same as in boards in thickness group 16 mm, whereas for board 100SD:0CF, the value obtained is 0.78 N/mm², but this value decreases to 0.67 N/mm² when 30% coconut fibre is added in board 70SD:30CF. However, as the proportion of coconut fibre increased from 50%,

70%, and 100% in board 50SD:50CF, 30SD:70CF, and 0SD:100CF, the internal bonding also increased with values of 0.72 N/mm², 0.75 N/mm², and 1.08 N/mm², respectively. All boards in thickness group 20 mm surpass the requirement of 0.40 N/mm².

4. Conclusions

As a conclusion, the objective of this paper, to evaluate the physical properties and mechanical performances of hybrid particleboards made up of agricultural wastes, i.e., sawdust and coconut fibre, has been achieved. All 15 types of hybrid particleboard have been tested, whereby the optimum composition of sawdust to coconut fibre and its suitable thickness have also been identified. Technically, the higher the composition of coconut fibre in the mixed design, the better the physical and mechanical performance, which can be proven by boards with thickness of 20 mm, where the thickness swelling and water absorption percentage decreased as the composition of coconut fibre is more than the composition of sawdust particle in the mixed design. Furthermore, for the modulus of rupture on bending for the board in the thickness group of 20 mm, it increased as the composition of coconut fibre is higher than the composition of sawdust particles, even though the modulus of elasticity showed an inverted trend where the value surpassed the requirement for boards with less composition of coconut fibre than the sawdust particle. In addition, tensile strength or internal bonding for boards with a higher composition of coconut fibre than sawdust particle has a higher value, meeting the requirements. Therefore, the optimum composition of sawdust to coconut fibre and suitable thickness show that the best result in both physical properties and mechanical performances is 0SD:100CF (0% sawdust to 100% coconut fibre) in the thickness group of 20 mm. In addition, another interesting finding is that, so long as the composition of sawdust is not exceeding 50% in the mixed design, the physical properties and mechanical performances still meet the standard's requirement. With the above significant empirical findings using the robust methodology (i.e., lab testing), this hybrid material, valorising green, recyclable agriculture wastes, offers invaluable insights and promotes sustainability for building construction and architectural industries. However, the empirical results reported herein should be considered in the light of some limitations. In correspondence to the British Standard used for this study, more physical and mechanical performances tests can be executed to produce a particleboard with good or even greater qualities other than Type P3. Last but not least, the findings can be substantiated and extended in future research by considering a bigger sample size of particleboards, incorporating thermal and insulation variables too, in order to provide more holistic, comprehensive results.

Author Contributions: All authors contributed to the manuscript. Conceptualization, E.A., N.H.A.S.L. and N.M.Z.N.S.; D.N.b.T. and E.A. collected and evaluated, in a coordinated way, all the publications mentioned in the paper; P.C.L., G.H.T.L. and M.H.A. contributed to visualization & editing. With this material, D.N.b.T. wrote a preliminary version of the article that was further enriched with suggestions and contributions by the rest of the authors. All authors have read and agreed to the published version of the manuscript.

Funding: This research publication was funded by UTM Transdisciplinary Research Grant No. Q.J130000.3551.06G64 and Q.J130000.3552.07G55.

Institutional Review Board Statement: Not applicable.

Informed Consent Statement: Not applicable.

Data Availability Statement: Not applicable.

Acknowledgments: The authors wish to deliver appreciation to UTM Transdisciplinary Research Grant TDR 47 for the funding, Heveaboard Sdn Bhd for the courtesy providing sawdust and resin (UF) as well as to University Tun Hussein Onn for allowing fabrication work of particleboard in Timber Fabrication Laboratory, Faculty of Civil Engineering and Built Environment.

Conflicts of Interest: The authors declare no conflict of interest. The funders had no role in the design of the study; in the collection, analyses, or interpretation of data; in the writing of the manuscript, or in the decision to publish the results.

References

1. Jonsson, R.; Hurmekoski, E.; Hetemäki, L.; Prestemon, J. What Is the Current State of Forest Product Markets and How Will They Develop in the Future? In *Towards a Sustainable European Forest-based Bioeconomy—Assessment and the way forward*; European Forest Institute: Joensuu, Finland, 2017; pp. 126–131. Available online: https://www.efi.int/sites/default/files/files/publication-bank/2018/efi_wsctu8_2017.pdf (accessed on 26 May 2021).
2. Stark, N.M.; Cai, Z.; Carll, C. Chapter 11—Wood-Based Composite Materials Panel Products, Glued-Laminated Timber, Structural Materials. In *Wood Handbook, Wood as an Engineering Material*; General Technical Report FPL-GTR-282; Department of Agriculture, Forest Service, Forest Products Laboratory: Madison, WI, USA, 2021; pp. 1–28.
3. Cai, Z.; Robert, J.R. CHAPTER 12: Mechanical Properties of Wood-Based Composite Materials, General Technical Report FPL-GTR-190; Department of Agriculture, Forest Service, Forest Products Laboratory: Madison, WI, USA, 2021; pp. 1–12.
4. Saeli, M.; Piccirillo, C.; Tobaldi, D.M.; Binions, R.; Castro, P.M.; Pullar, R.C. A sustainable replacement for TiO₂ in photocatalyst construction materials: Hydroxyapatite-based photocatalytic additives, made from the valorisation of food wastes of marine origin. *J. Clean. Prod.* **2018**, *193*, 115–127. [[CrossRef](#)]
5. Garcia-Garcia, G.; Stone, J.; Rahimifard, S. Opportunities for waste valorisation in the food industry—A case study with four UK food manufacturers. *J. Clean. Prod.* **2019**, *211*, 1339–1356. [[CrossRef](#)]
6. McNutt, J.; He, Q. (Sophia) Spent coffee grounds: A review on current utilization. *J. Ind. Eng. Chem.* **2019**, *71*, 78–88. [[CrossRef](#)]
7. Abdullah, A.; Lee, C. Effect of Treatments on Properties of Cement-fiber Bricks Utilizing Rice Husk, Corncob and Coconut Coir. *Procedia Eng.* **2017**, *180*, 1266–1273. [[CrossRef](#)]
8. Freire, A.L.F.; Júnior, C.P.D.A.; Rosa, M.D.F.; Neto, J.A.D.A.; De Figueirêdo, M.C.B. Environmental assessment of bioproducts in development stage: The case of fiberboards made from coconut residues. *J. Clean. Prod.* **2017**, *153*, 230–241. [[CrossRef](#)]
9. Adedirán, A.A.; Olawale, O.; Ojediran, J.; Aladegboye, S.; Atoyebi, O.D.; Akinlabi, E.T.; Olayanju, A. Properties of agro-based hybrid particleboards. *Procedia Manuf.* **2019**, *35*, 442–446. [[CrossRef](#)]
10. Discipline, W.T.; Luang, K. Particleboard from coir pith. *Bangladesh J. Sci. Ind. Res.* **2016**, *51*, 239–245.
11. Kadja, K.; Drovou, S.; Kassegne, K.A.; Pizzi, A.; Sanda, K.; Batako, A.D. Development and Investigation into Properties of composite Particleboard of Iroko and African Locust Bean Pod. *Procedia Manuf.* **2019**, *30*, 188–193. [[CrossRef](#)]
12. El-Kassas, A.; Mourad, A.-H. Novel fibers preparation technique for manufacturing of rice straw based fiberboards and their characterization. *Mater. Des.* **2013**, *50*, 757–765. [[CrossRef](#)]
13. Akinyemi, A.B.; Afolayan, J.; Oluwatobi, E.O. Some properties of composite corn cob and sawdust particle boards. *Constr. Build. Mater.* **2016**, *127*, 436–441. [[CrossRef](#)]
14. Paridah, M.; Juliana, A.H.; El-Shekeil, Y.; Jawaid, M.; Alothman, O.Y. Measurement of mechanical and physical properties of particleboard by hybridization of kenaf with rubberwood particles. *Measurement* **2014**, *56*, 70–80. [[CrossRef](#)]
15. Wei, K.; Lv, C.; Chen, M.; Zhou, X.; Dai, Z.; Shen, D. Development and performance evaluation of a new thermal insulation material from rice straw using high frequency hot-pressing. *Energy Build.* **2015**, *87*, 116–122. [[CrossRef](#)]
16. Alam, M.; Sapuan, S.; Mansor, M. *Design Characteristics, Codes and Standards of Natural Fibre Composites*; Elsevier Ltd.: Amsterdam, The Netherlands, 2017; pp. 511–528.
17. Marimuthu, K.P.; Kumar, S.M.; Kumar, V.R.; Govindaraju, H. Characterization of Mechanical Properties of Epoxy Reinforced with Glass Fiber and Coconut Fiber. *Mater. Today Proc.* **2019**, *16*, 661–667. [[CrossRef](#)]
18. Danso, H. Properties of Coconut, Oil Palm and Bagasse Fibres: As Potential Building Materials. *Procedia Eng.* **2017**, *200*, 1–9. [[CrossRef](#)]
19. Ngadiman, N.; Kaamin, M.; Kadir, A.A.; Sahat, S.; Zaini, A.; Zentan, S.R.N.; Ahmad, N.A.; Amran, W.H.A.W. Panel Board from Coconut Fibre and Pet Bottle. *E3S Web Conf.* **2018**, *34*, 01014. [[CrossRef](#)]
20. Azman, M.N.; Majid, T.A.; Ahamad, M.S.; Hanafi, M.H. A Study on the Trend of The Use of Ibs Components and the Setting Up of Ibs Manufacturing Factories in the Malaysian Construction Industry. *Malays. Constr. Res. J.* **2010**, *9*, 18–30.
21. Merkus, H.G. Sieves and Sieving. In *Particle Size Measurements*; Springer: Dordrecht, The Netherlands, 2009; Volume 17, pp. 219–240.
22. Cosereanu, C.; Cerbu, C. Rape/wood particleboard. *BioResources* **2019**, *14*, 2903–2918.
23. BS EN 312. *BS EN 312:2010 BSI Standards Publication Particleboards—Specifications*; British Standard: London, UK, 2010.
24. British Standard. *Wood-Based Panels—Determination of Density*; British Standard: London, UK, 1993; pp. 1–12.
25. EN-317. *European Committee for Standardization. Particleboards and fiberboards—Determination of Swelling in Thick-Ness after Immersion in Water*; British Standard: London, UK, 1993.
26. CEN. *EN 310 Wood-Based Panels—Determination of Modulus of Elasticity in Bending and of Bending Strength*; CEN: Brussels, Belgium, 1996.
27. European Committee for Standardization. *Particleboards and Fiberboards—Determination of Tensile Strength Perpendicular to the Plane of Board*; EN319; European Committee for Standardization: Brussels, Belgium, 1993.