

## Design of shunt hybrid active power filter for compensating harmonic currents and reactive power

Ibrahim Alhamrouni<sup>1</sup>, F. N. Hanafi<sup>2</sup>, Mohamed Salem<sup>3</sup>,  
Nadia H. A. Rahman<sup>4</sup>, Awang Jusoh<sup>5</sup>, T. Sutikno<sup>6</sup>

<sup>1,2,4</sup>Electrical Engineering Section, University Kuala Lumpur, Malaysia

<sup>3</sup>School of Electrical and Electronic Engineering, Universiti Sains Malaysia, Malaysia

<sup>5</sup>School of Electrical Engineering, Universiti Teknologi Malaysia, Malaysia

<sup>6</sup>Department of Electrical Engineering, Universitas Ahmad Dahlan, Indonesia

---

### Article Info

#### Article history:

Received Jan 4, 2020

Revised Mar 25, 2020

Accepted Apr 12, 2020

---

#### Keywords:

Harmonic

Hybrid active filter

Pi controller

Power factor correction

P-q theory

---

### ABSTRACT

For the past two decades, tremendous advancements have been achieved in the electricity industry. The usage of non-linear loads in the daily life has affected the power quality of the system and caused the presence of harmonics. To compensate the harmonic currents and reactive power in the system, the design of shunt hybrid active power filter has been proposed in this research. The design of the filter has included several control systems of instantaneous active and reactive power (p-q) theory and PI controller to investigate the performance of the filter. The robustness of the designed hybrid power filter has also been benchmarked with the other filter topologies available in literature. The hybrid power filter will combine passive power filter and active power filter configured in shunt connection. The result of this research showed that the total harmonic distortion analyzed is below than 5% according to IEEE-519 standard requirements and reactive power is compensated proved by the increase in power factor. The shunt hybrid active power filter is designed, and simulation result is analyzed by using MATLAB-Simulink environment.

*This is an open access article under the [CC BY-SA](https://creativecommons.org/licenses/by-sa/4.0/) license.*



---

### Corresponding Author:

Ibrahim Alhamrouni,

Electrical Engineering Section,

Universiti Kuala Lumpur British Malaysian Institute (UniKL BMI),

Gombak 53100, Malaysia.

Email: [ibrahim.mohamed@unikl.edu.my](mailto:ibrahim.mohamed@unikl.edu.my)

---

## 1. INTRODUCTION

Power quality and efficiency are very important as industries, economics and daily life are completely relying on electricity. There is some type of issues that need to be considered, such as harmonics, when generating and transmitting the electrical power and also when used by the consumers. Harmonics is integral multiple of fundamental frequency that distorts the waveforms or signals of voltage and current caused by the non-linear loads, such as inductive loads or switched-mode power supplies equipment [1, 2]. Harmonics can cause overheating and increase iron losses in transformer, reduce torque in motor and destroy a power system of electrical appliances [3]. According to the global standard of IEEE 519, the maximum limit of harmonic distortion (THD) allowed in a system is 5% [4, 5]. Therefore, harmonics need to be minimized to increase the efficiency of a power system [6]. Several types of filters have been proposed for the purpose of harmonic components mitigation. The first filter developed is passive LC power filter, which is a combination of capacitors and inductors that commonly connected in parallel with the loads. However, this filter can also

be connected in series with the system to mitigate the single frequency of harmonic current, but it is not suitable as it generates high impedance for the harmonic components. The passive power filter (PPF) helps to channel the harmonic currents to the ground that will provide reactive power to correct the power factor [7]. Although it may help to reduce the harmonics, passive filters are not suitable for variable loads and appearance of resonance for certain harmonic [8]. Another approach used to minimize harmonics is active power filter (APF). There are two types of active filters configuration which are series and shunt [9]. The series active power filter is configured in series with the distribution system through same transformer. The principle application is the same as shunt APF because it uses the same controller of VSI, but it is uncommon with shunt APF because it uses interfacing transformer instead of inductor. The series APF is best to use as the voltage harmonic mitigation. The filter will mitigate the harmonic voltage distortion between the non-linear loads and the source. The harmonic is eliminated and pure sinusoidal wave in the load is maintained by injecting harmonic voltage to compensate the voltage waveform from the voltage source. Therefore, it is usually used at the voltage source of the electrical systems. However, series APF is less common to be used because it has high rating current loads that can cause I<sup>2</sup>R losses. Shunt active power filter is commonly used configuration in application of active filters. The shunt active filter is connected in parallel to the harmonic source loads and consists of controllable voltage and current sources. The most commonly used in the filtering industries is voltage source inverter (VSI) type driven by pulse-width modulation technique. The method of compensating the harmonics is by injecting the harmonic currents into the non-linear loads at equal amplitude with opposite phase displacement. It is potential to connect some shunt APF in parallel to make it suitable for high range of power ratings.

Shunt active filter is used for compensating the reactive power and harmonic currents. Although the cost of this type of filters is expensive for large-scale system, the compensation efficiency is better than the series active filter [10]. Different from series type, shunt active filter is commonly used in the industry especially since it is appropriate for wide range power rating system. To compensate the harmonic components, several techniques are used, such as instantaneous reactive power (p-q) theory, synchronous dq reference frame theory and Lyapunov-function-based control theory. Several control methods are also used in the filter in order to improve the performance. Considering the available designs and topologies of different filters for the purpose of mitigating harmonics, the issue has yet to be solved. Whereas several drawbacks have been found when using previously proposed techniques. The first downside that can be noticed is the inability to compensate or mitigate the harmonic issue, where some previous methods failed to mitigate the harmonic issue to the limit where it complies with the specified standards [11]. The second drawback of the previous studies is that, the high cost of implementing the proposed technique. Where some available methods are found to be not totally cost effective for the utilities which limit their application to solve the raised issue [12]. Another shortcoming of the methods in the literature is the consequences of applying the mitigation technique, where some methods help to mitigate the harmonics to the desired level [13]. On the other side, they create different problem in the system such as resonance and losses issues.

To overcome the previously encountered issues by other mitigation techniques, this paper presents a hybrid active power filter (HAPF) that combines the passive power filter and active power filter particularly for high power non-linear loads. In this research, control methods such as proportional integral (PI) controller is used to control the DC voltage of the filter. Another controller applied in this filter is also hysteresis current controller (HCC) which will force the actual current to track the reference compensated current in the hysteresis band. Furthermore, low pass filter (LPF) is also added to obtain the important components directly from electrical signal of the distorted voltage and current into the form of  $\alpha$ - $\beta$  reference frame under distorted current conditions. All these control methods are used to enhance the performance of the hybrid active power filter. The design of the hybrid active power filter is simulated in MATLAB-Simulink environment.

## 2. HYBRID ACTIVE FILTER TOPOLOGY

HAPF is a combination of passive filters and active filter. The filter designed in shunt configuration as shown in Figure 1. It has both advantages of passive filter and active filter to compensate the harmonic component effectively. This system also implemented with voltage source inverter (VSI), low pass filter (LPF), PI controller and hysteresis current controller (HCC). As for non-linear load, the diode rectifier with smoothing DC capacitor and inductor is used to create specified current distortion. The AC side and source impedance will influence the amplitude of harmonic current in the waveforms. Because of the harmonic voltage distortion cause by the non-linear load, passive power filter (PPF) is commonly used to compensate the harmonic distortion in the power system at the low switching frequency operation. The PPF consists of capacitor and inductor [7]. However, the presence of harmonic current makes the L-C less effective to be used alone in the power system [8]. The configuration of PPF will be in parallel as it is effective to compensate harmonic currents and mitigate limited voltage distortion, it also provides low impedance path for harmonic components to flow through at the loads end. This filter also provides reactive power for power factor correction. The type

of filter used are single tuned band-pass filter that tuned single frequency. However, the PPF will generate the resonance and new harmonics to the power systems. To eliminate the risk of resonance and presence of new harmonics, active power filter (APF) is used in the system at the high switching frequency operation to improve the performance of PPF. The APF will inject the compensating currents to generate pure sinusoidal source current at the unity power factor of the non-linear loads. The configuration of APF will be shunt since shunt active filter (APF) is the most common filter used at the power systems.

The voltage source inverter (VSI) will provide voltage source for the filter at the DC bus control by HCC method. The amplitude, frequency and phase of the voltage are controllable [11]. It is controlled so that the output current of the inverter is forced to follow the reference currents. The HCC extraction method is used so that the comparison of the fundamental currents and reference current can be produced. For the fast response current controlled inverters such as APF, it is important to have effective current control technique. Hysteresis current control (HCC) is an effective and accurate feedback current control method by forcing the actual current to track the reference current within the hysteresis band to generate the required triggering pulses [14]. In order to produce the control pulses for VSI switches, the actual currents of  $I_a$ ,  $I_b$  and  $I_c$  are evaluated in the hysteresis current controller so that the actual currents will track the reference currents closely inside the hysteresis band. The hysteresis band is the tolerance boundary of the compensating current. The currents diverge between upper and lower hysteresis band. The current changes from upper to lower of hysteresis band and vice versa will illustrate as the switching frequency of the HCC. Therefore, the switching frequency is not constant during the switching operation of VSI and modifies according to the current waveform. The APF will use instantaneous reactive power theory (p-q theory) as a control technique for the compensation of reference current that will be extracted by LPF. Low pass filter is used to improve the performance of the shunt HAPF to mitigate harmonic by filtering the distorted  $\alpha$ - $\beta$  components and extract the undistorted and balance voltage or current in a signal to obtain the average power desired.

This filter allows lower frequency than the cut-off frequency and rejects high frequency. The compensate reference currents, it is evaluated by PI controller and the HCC will generate signal output. Proportional integral (PI) controller is the most common controller used for DC bus voltage in shunt active power filters. PI controller is used to track the reference current from the measured DC bus voltage [15]. The shunt active power filter has several control algorithms including evaluation of the reference current signals for each of the three-phases of the inverter, produce the inverter gating pulses and sustain the dc link voltage constant. In order to maintain the dc link voltage constant, the DC capacitor voltage,  $V_{DC}$  is measured and compared to the voltage references value,  $V_{DC REF}$ . The configuration of the hybrid active power filter is in shunt. The HAPF will combine one or more of shunt PPF and low-rated shunt APF connected in series at the three-phase power system

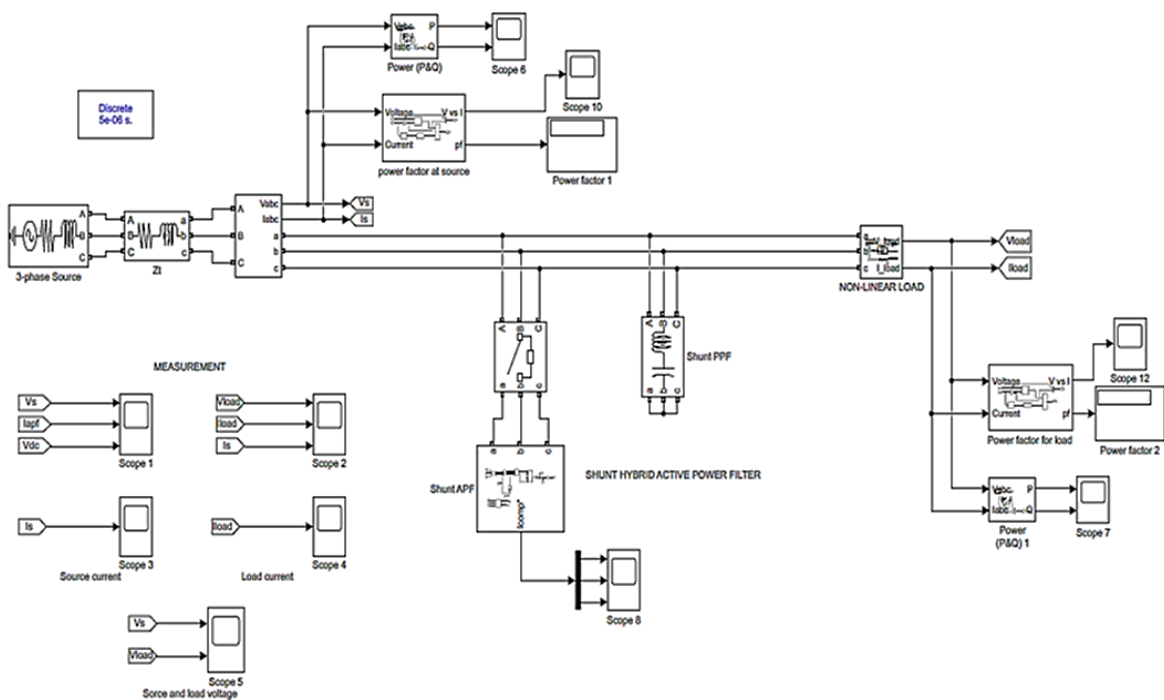

Figure 1. Proposed shunt hybrid active power filter circuit configuration

### 3. INSTANTANEOUS ACTIVE AND REACTIVE POWER THEORY

The p-q theory has been previously presented in [16, 17]. This theory has been used differently in this research, where it is specified on the instantaneous values of three phase power systems with or without the neutral wire and proved to be valid for transient as well as steady state situations. The idea of this theory is to generate the harmonic components to be suppressed with the non-linear loads. The p-q theory uses a Clarke transformation to voltages and currents from the three-phase 'a-b-c' by shifting the phase of the actual signal to 90° and transform to two-phase system, which is defined instantaneously. The three-phase load current and voltage is converted into  $\alpha$ - $\beta$  form using Clarke transformation matrix as follows:

$$\begin{bmatrix} I_\alpha \\ I_\beta \end{bmatrix} = [T] \begin{bmatrix} I_{La} \\ I_{Lb} \\ I_{Lc} \end{bmatrix} \quad (1)$$

where:  $T_{p-q}$  is the transformation matrix as:

$$T = \sqrt{2/3} \begin{bmatrix} 1 & 1/2 & -1/2 \\ 0 & \sqrt{3}/2 & -\sqrt{3}/2 \end{bmatrix} \quad (2)$$

The current in the  $\alpha$ - $\beta$  axis can be separated into DC and AC components by:

$$I_\alpha = \dot{I}_\alpha + \hat{I}_\alpha \quad (3)$$

$$I_\beta = \dot{I}_\beta + \hat{I}_\beta \quad (4)$$

Afterwards, the fundamental components at the pulse will be obtained by LPF directly from the  $\alpha$ - $\beta$  axis of the currents. The  $\alpha$ - $\beta$  components of the load currents are calculated by deducting the LPF input signals from the equivalent outputs. The resulting signals are the AC components of  $\dot{I}_\alpha$  and  $\dot{I}_\beta$  which are equivalent with the harmonic components of the load currents in the stationary reference frame.

The voltage source will be transformed to  $\alpha$ - $\beta$  of the reference frame by:

$$\begin{bmatrix} V_\alpha \\ V_\beta \end{bmatrix} = [T] \begin{bmatrix} V_{Sa} \\ V_{Sb} \\ V_{Sc} \end{bmatrix} \quad (5)$$

The instantaneous active and reactive power of P and Q are specified by:

$$P = \hat{P} + \ddot{P}, \quad P = (I_\alpha)(\hat{V}_\alpha) + (I_\beta)(\hat{V}_\beta) \quad (6)$$

$$Q = \hat{Q} + \ddot{Q}, \quad Q = (I_\beta)(\hat{V}_\alpha) + (I_\alpha)(\hat{V}_\beta) \quad (7)$$

where:

$\hat{P}$  and  $\hat{Q}$  are the fundamental components

$\ddot{P}$  and  $\ddot{Q}$  are the AC components

The  $\ddot{P}$  and  $\ddot{Q}$  that related to the  $\alpha$ - $\beta$  of the same voltages and currents can also be written as:

$$\begin{bmatrix} \ddot{P} \\ \ddot{Q} \end{bmatrix} = \begin{bmatrix} \hat{V}_\alpha & \hat{V}_\beta \\ -\hat{V}_\beta & \hat{V}_\alpha \end{bmatrix} \begin{bmatrix} I_\alpha \\ I_\beta \end{bmatrix} \quad (8)$$

The active power required,  $P_c$  then will be added to the AC components of the instantaneous real power,  $\ddot{P}$  for regulation of the DC bus voltage. Lastly, the filter reference current in the 'a-b-c' frame can be obtained by;

$$\begin{bmatrix} \hat{I}_a \\ \hat{I}_b \\ \hat{I}_c \end{bmatrix} = \sqrt{2/3} \begin{bmatrix} 1 & 0 \\ 1/2 & \sqrt{3}/2 \\ -1/2 & -\sqrt{3}/2 \end{bmatrix} \quad (9)$$

#### 4. RESULTS AND ANALYSIS

In order to validate the performance of the proposed HAPF, the complete model of the system has been built and simulated in MATLAB-Simulink environment. The main aspects of the simulation are to study 1) the harmonic components impact on the system; 2) the harmonic currents compensated by using different types of filters; 3) the reactive power compensation impact on the power factor. In addition, the simulated results and THD values are analyzed to investigate the performance of each filter used. The parameters values and specifications of the shunt hybrid active power filter illustrated in Figure 1 are presented in Table 1.

Table 1. Specification parameters

Specification Parameters	Values
Phase voltage and frequency	$V_S = 400 \text{ V}$ , $f = 50 \text{ Hz}$
Line impedance	$R = 0.01 \Omega$ , $L = 1 \mu\text{H}$
Current-source non-linear	$L = 10 \text{ mH}$ , $R = 70 \Omega$
Passive filter parameter	$L = 1.11 \text{ mH}$ , $C = 196 \mu\text{F}$
DC-capacitance	$C_{DC} = 3.5 \mu\text{F}$
Inner controller parameter	$K_p = 0.1$ , $K_i = 1$

##### 4.1. Harmonic impact on the system

Figure 2. shows that the voltage of the three-phase source,  $V_S$  and load voltage,  $V_L$  is balanced and not distorted in this case. The harmonic components presence is caused by the inductive non-linear load where reluctant square wave had formed in the load current waveform. The reluctant square wave formed had also affected the three-phase current source waveform as shown in Figure 3. The time response for the system is set to be  $t = 0.2\text{s}$  as it is the most dynamic time response. The value of THD encountered in the non-linear system is same as the THD value in the system which is 28.53% as shown in Figure 4. The harmonic occurred in the non-linear load has affected the current source and caused the THD value to be higher than the IEEE standard requirement.

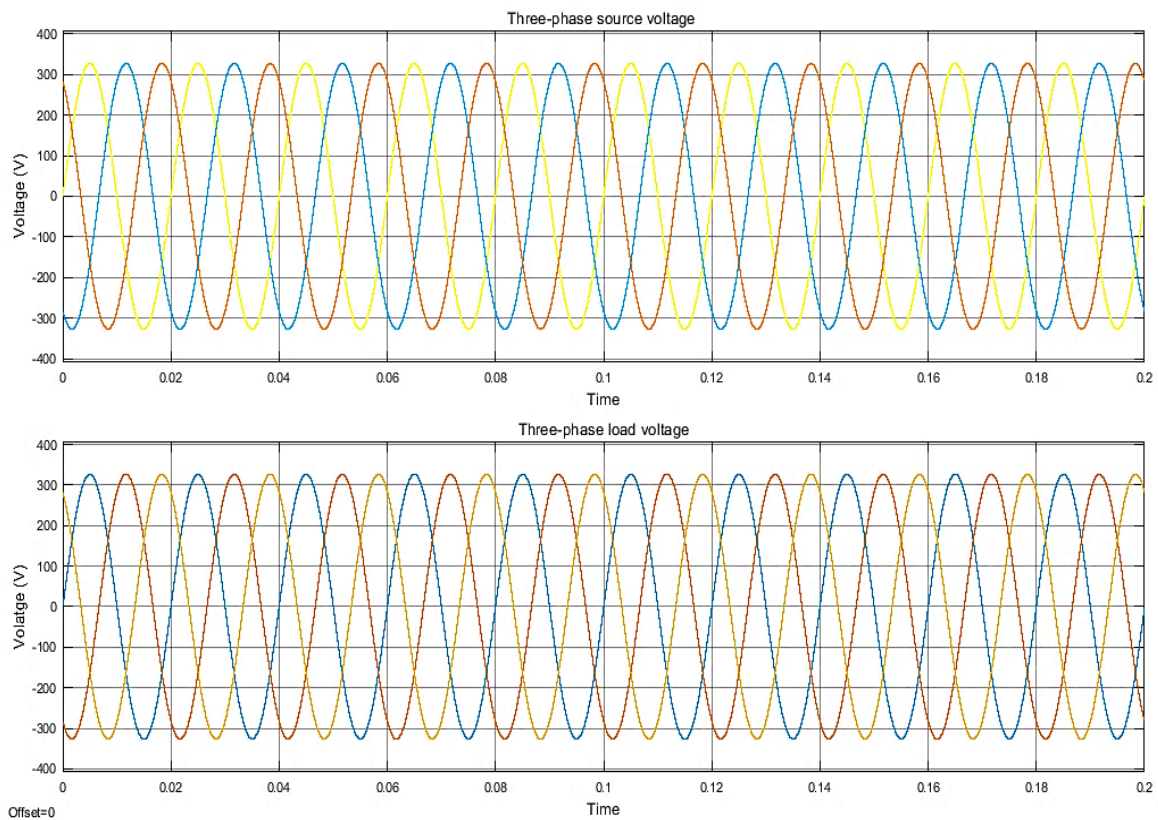

Figure 2. Three-phase source voltage and load voltage

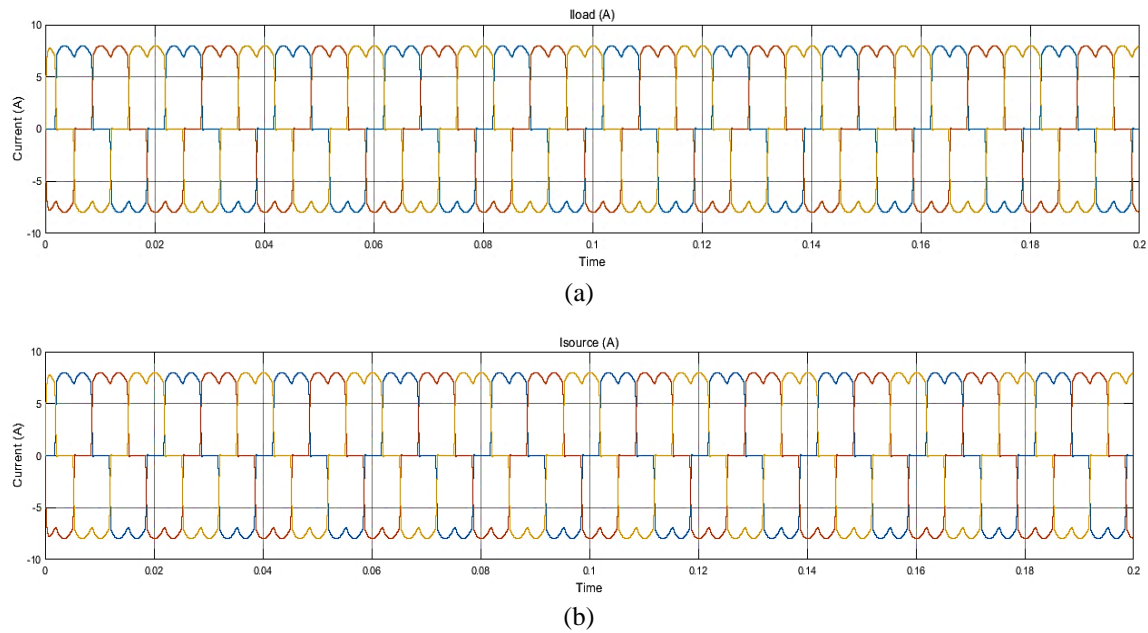

Figure 3. (a) Three-phase load current, and (b) three-phase source current

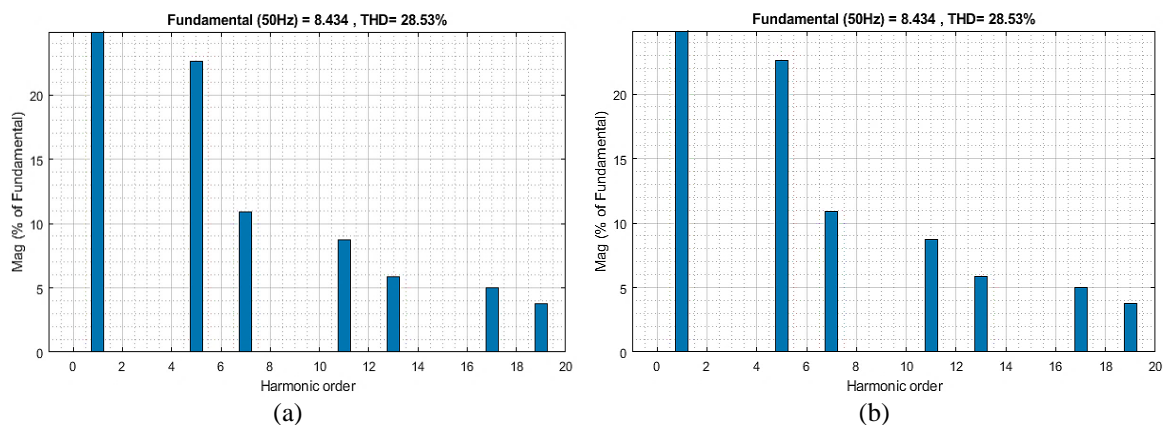

Figure 4. (a) THD value of source current in phase and (b) THD value of non-linear load current

#### 4.2. Harmonic compensation using different type of filters

In this part, the harmonic currents have been compensated by using different types of filters. The filters used are shunt PPF, shunt APF and shunt HAPF. The purpose of that is to benchmark and compare the robustness of the performance of each filter in terms of harmonic currents compensation and reduction of THD value. Figure 5 shows the difference of each current source waveform after different filters are applied. The current compensation has been improved with respect to the filters used. The current source waveform has compensated to almost sinusoidal waveform after shunt HAPF has been utilized comparing to the other filters used. The HAPF compensated the harmonic currents by providing the low impedance path to the single harmonic components in the PPF and the other harmonic components are mitigated by using p-q theory controller. This controller compensated the three-phase current in the form of two-phase in  $\alpha$ - $\beta$  form. The reference current is injected in the system through hysteresis current controller to allow the actual current track the reference current in the hysteresis band. The PI controller is used to track the reference current from the measured DC voltage. This controller allows the filter to compensate the harmonic current even in the stable three-phase voltage system. The value of THD also improved and reduced according to the other filters used. The THD value after shunt HAPF is applied is reduced from 28.53% to 1.96% as shown in Figure 6. According to IEEE 519 standard, the value of THD allowed in the system must be below than 5%. Therefore, the THD value after applying shunt HAPF is in parallel with the standard requirement. However, compared to the obtained result of THD value with respect to the previous research done in [10, 18-23], the THD value is 2.60% slightly higher than the simulation result obtained in this research.

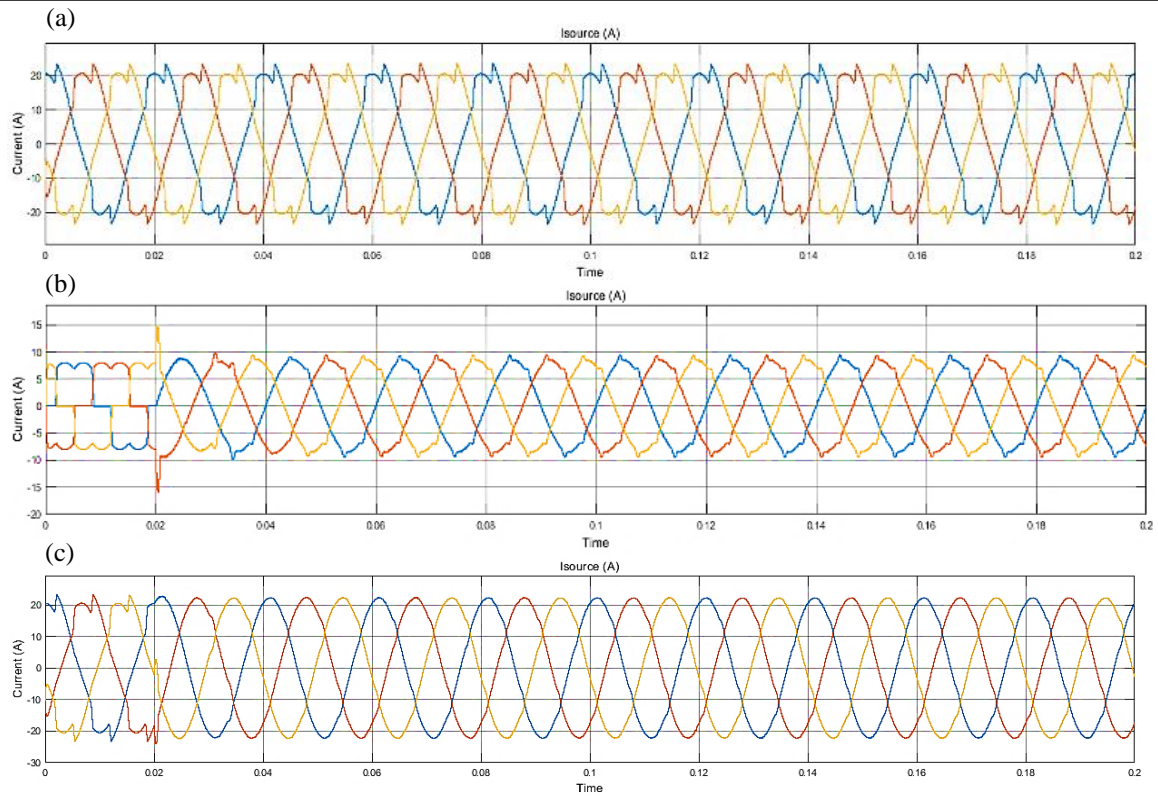

Figure 5. (a) Current source after applied shunt PPF, (b) current source after applied APF, and (c) current source after applied shunt HAPF

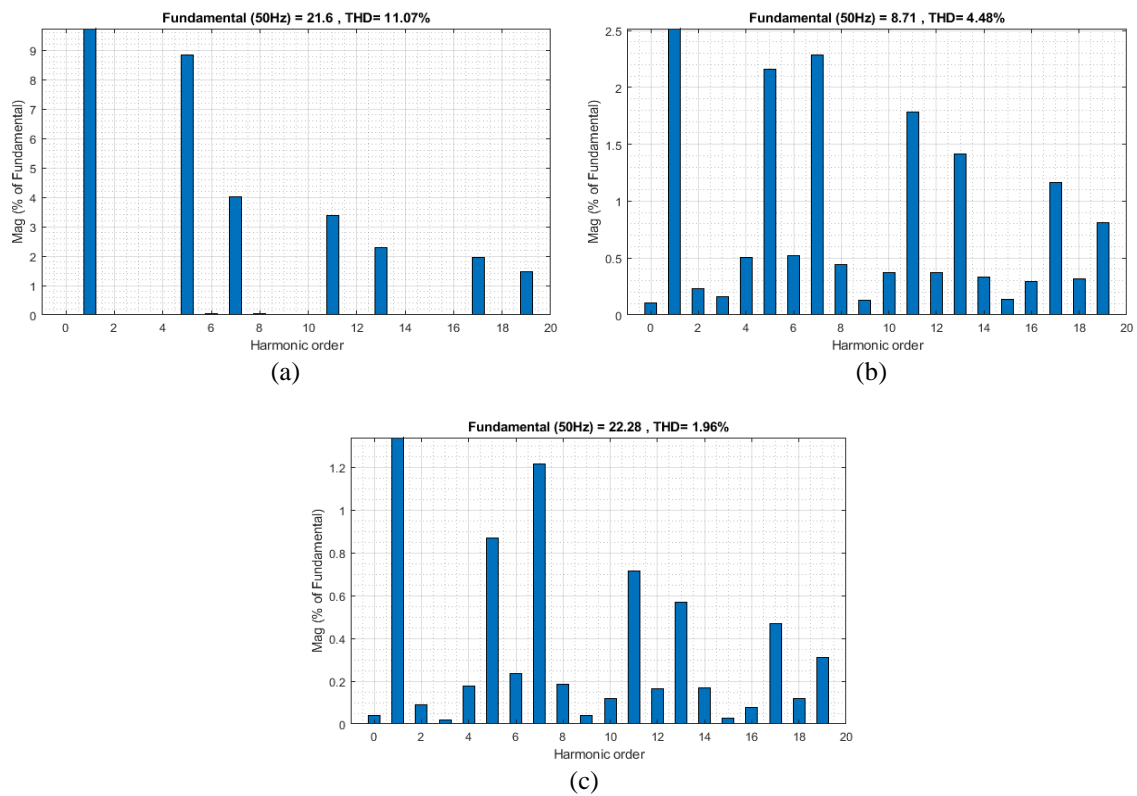

Figure 6. (a) THD value of source current after applied shunt PPF, (b) THD value of source current after applied shunt APF, and (c) THD value of source current after applied shunt HAPF

### 4.3. Reactive power compensation effect to power factor correction

The filters used to compensate the harmonic current also provided reactive power compensation. The inductive non-linear load happened to absorb the reactive power and effect the power factor as reactive power is undesired power in the system [24, 25]. The power factor of the non-linear load is considered low which is 0.65. Figure 7 shows the active and reactive power before filters were applied. Therefore, the application of the filter managed to correct the power factor by compensating the reactive power. After shunt HAPF has been applied to the system, the power factor improved to almost unity which is 0.96. Figure 8 shows the reactive power compensated by using different types of filters. The reactive power is provided by the use of capacitor in the PPF and APF filter.

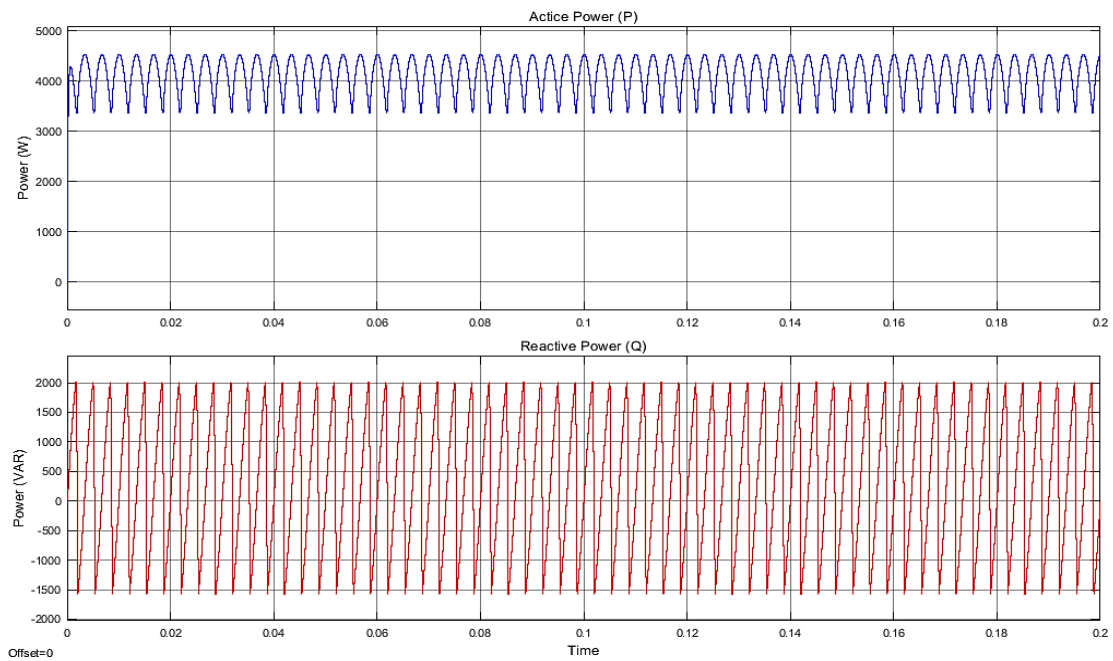
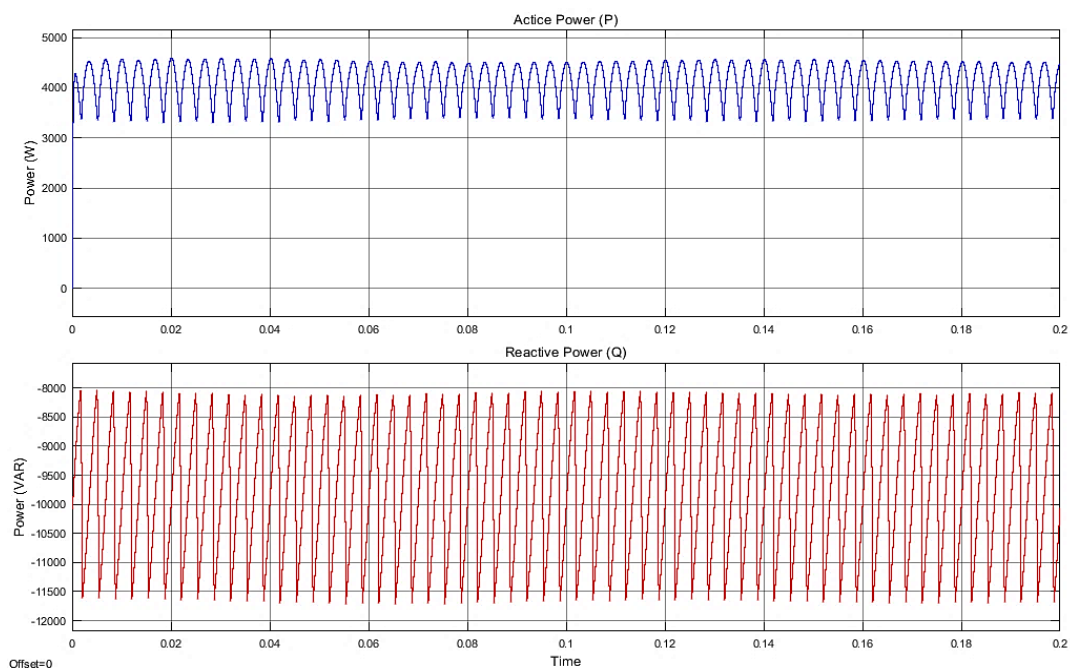

Figure 7. Active and reactive power before compensation



(a)

Figure 8. (a) Compensated reactive power after shunt PPF applied



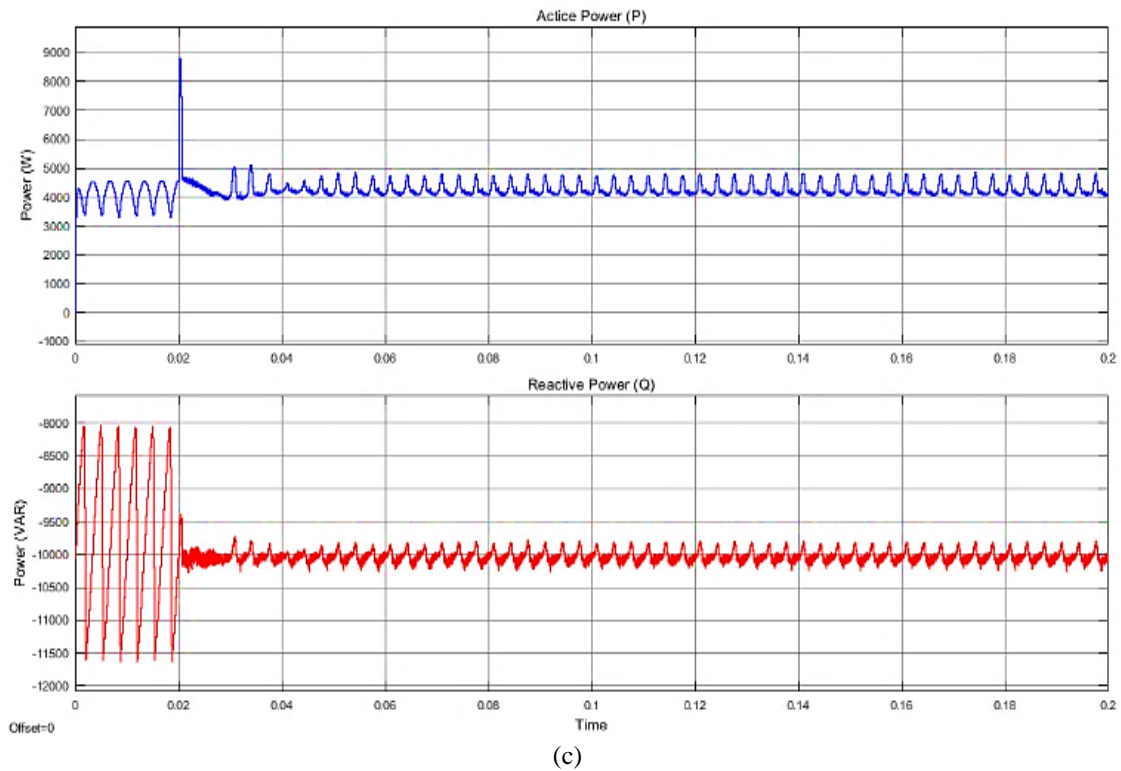
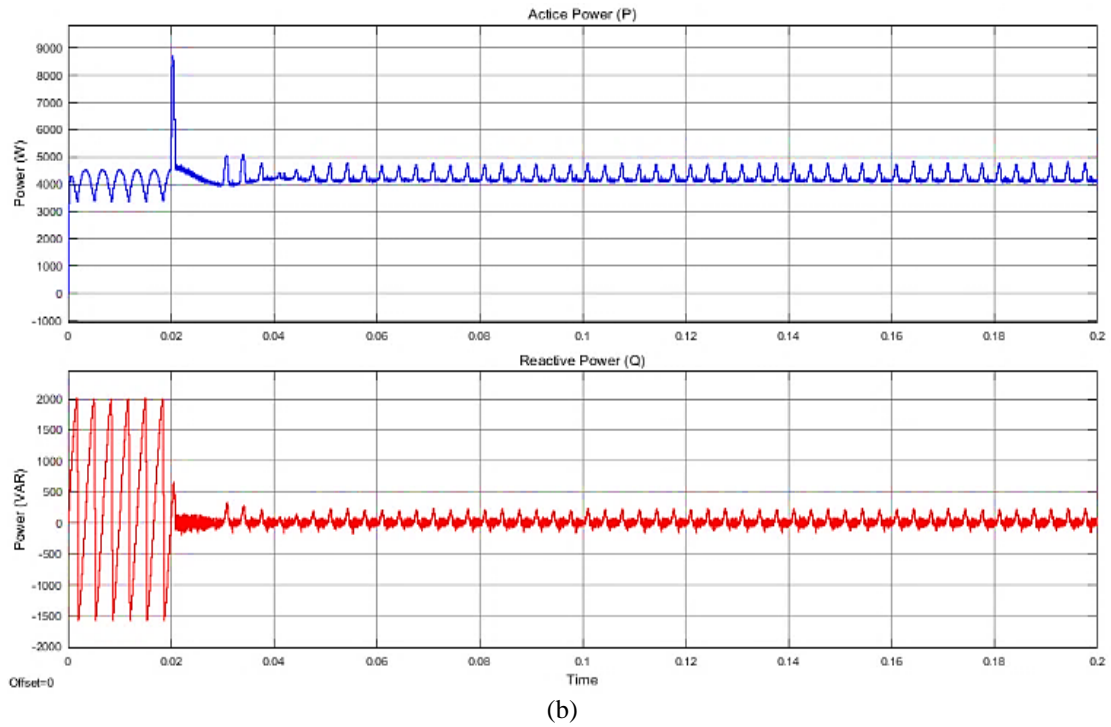

Figure 8. (b) compensated reactive power after shunt APF applied, and (c) compensated reactive power after shunt HAPF applied (continue)

### 5. CONCLUSION

This paper presented a method to compensate harmonic currents components and reactive power of a polluted power system. For this purpose, a shunt hybrid active power filter (HAPF) is designed in this research. The combination of shunt passive power filter (PPF) and shunt active power filter (APF) are connected in shunt configuration. The filter used control method of proportional integral (PI) controller, Hysteresis current

controller (HCC) and instantaneous active and reactive power (p-q) theory controller. From the results obtained, the three-phase power system connected to non-linear load produced reluctant square current waveform and high value of THD. Nevertheless, by applying the proposed shunt HAPF in the system, the current waveform produced is compensated to almost sinusoidal waveform. The THD value have also been reduced according to IEEE 519 standard requirements. The reactive power has also been compensated for significantly improving the power factor as the reactive power has been supplied to the system. The robustness of the proposed shunt HAPF has been validated and compared to the other filters previously used which are PPF and APF.

## REFERENCES

- [1] E. L. Owen, "A history of harmonics in power systems," *IEEE Industry Applications Magazine*, vol. 4, pp. 6-12, 1998.
- [2] D. A. Katsaprakakis, et al., "A power-quality measure," *IEEE transactions on Power Delivery*, vol. 23, no. 2, pp. 553-561, April 2008.
- [3] H. A. Attia, et al., "Harmonic distortion effects and mitigation in distribution systems," *Journal of American Science*, vol. 6, pp. 173-183, 2010.
- [4] C. K. Duffey and R. P. Stratford, "Update of harmonic standard IEEE-519: IEEE recommended practices and requirements for harmonic control in electric power systems," *IEEE Transactions on Industry Applications*, vol. 25, no. 6, pp. 1025-1034, 1989.
- [5] I. F II, "IEEE recommended practices and requirements for harmonic control in electrical power systems," *New York, NY, USA*, 1993.
- [6] P. Salmeron, S. P. Litran, "A control strategy for hybrid power filter to compensate four-wires three-phase systems," *IEEE Transactions on Power Electronics*, vol. 25, no. 7, pp. 1923-1931, February 2010.
- [7] M. A. Mohamed, "Design of shunt active power filter to mitigate the harmonics caused by nonlinear loads," *Universiti Tun Hussein Onn Malaysia*, 2015.
- [8] P. Salmeron, S. P. Litran, "Improvement of the electric power quality using series active and shunt passive filters," *IEEE transactions on power delivery*, vol. 25, no. 2, pp. 1058-1067, December 2009.
- [9] Z. Salam, P. C. Tan, and A. Jusoh, "Harmonics mitigation using active power filter: A technological review," *Elektrika Journal of Electrical Engineering*, vol. 8, no. 2, pp. 17-26, 2006.
- [10] S. Rahmani, A. Hamadi, et al., "A combination of shunt hybrid power filter and thyristor-controlled reactor for power quality," *IEEE Transactions on Industrial Electronics*, vol. 61, no. 5, pp. 2152-2164, May 2013.
- [11] H. Abu-Rub, et al, "Predictive current control of voltage-source inverters," *IEEE Transactions on Industrial Electronics*, vol. 51, no. 1, pp. 585-593, February 2004.
- [12] Z. A. Memon, et al., "Design of Three-Phase Hybrid Active Power Filter for Compensating the Harmonic Currents of Three-Phase System," *Mehran University Research Journal of Engineering and Technology*, vol. 31, no. 2, April 2012.
- [13] S. Shabeer, A. Grover, and A. H. Bhat, "Shunt hybrid power filter for harmonic reduction to improve power quality using PI and hysteresis controller," *International Journal of Computer Applications*, vol. 147, no. 4, pp. 7-12, August 2016.
- [14] F. Zare and G. Ledwich, "A hysteresis current control for single-phase multilevel voltage source inverters: PLD implementation," *IEEE transactions on power electronics*, vol. 17, no. 5, pp. 731-738, November 2002.
- [15] P. Kumar and A. Mahajan, "Soft computing techniques for the control of an active power filter," *IEEE transactions on power delivery*, vol. 24, no. 2, pp. 452-461, December 2008.
- [16] . L. Afonso, M. S. Freitas, and J. S. Martins, "pq Theory power components calculations," *2003 IEEE International Symposium on Industrial Electronics (Cat. No. 03TH8692)*, pp. 385-390, 2003.
- [17] E. H. Watanabe, M. Arede, and H. Akagi, "The pq theory for active filter control: some problems and solutions," *Sba: Controle & Automação Sociedade Brasileira de Automatica*, vol. 15, pp. 78-84, 2004.
- [18] S. Rahmani, A. Hamadi, N. Mendalek, and K. Al-Haddad, "A new control technique for three-phase shunt hybrid power filter," *IEEE Transactions on industrial electronics*, vol. 56, no. 8, pp. 2904-2915, August 2009.
- [19] I. Alhamrouni, W. Wahab, et al., "Modeling of Micro-grid with the consideration of total harmonic distortion analysis," *Indonesian Journal of Electrical Engineering and Computer Science*, vol. 15, pp. 581-592, August 2019.
- [20] Y. Tang, P. C. Loh, et al., "Generalized design of high performance shunt active power filter with output LCL filter," *IEEE Transactions on Industrial Electronics*, vol. 59, no. 3, pp. 1443-1452, September 2011.
- [21] X. Sun, L. Yang, et al., "A novel impedance converter for harmonic damping in loop power distribution systems," *IEEE Journal of Emerging and Selected Topics in Power Electronics*, vol. 4, no. 1, pp. 162-173, March 2016.
- [22] I. Alhamrouni, M. Hairullah, et al., "Modelling and design of PID controller for voltage control of AC hybrid micro-grid," *International Journal of Power Electronics and Drive Systems*, vol. 10, no. 1, pp. 151-159, March 2019.
- [23] M. Salem, A. Jusoh, N. R. N. Idris, and I. Alhamrouni, "Comparison of LCL resonant converter with fixed frequency, and variable frequency controllers," *2017 IEEE Conference on Energy Conversion (CENCON)*, pp. 84-89, 2017.
- [24] A. F. Zobia, S. H. E. A. Aleem, "A new approach for harmonic distortion minimization in power systems supplying nonlinear loads," *IEEE transactions on Industrial informatics*, vol. 10, no. 2, pp. 1401-1412, February 2014.
- [25] M. R. Arif, F. Mahmood, M. Hashmi, and S. Hänninen, "Application of passive filters to mitigate power quality problems caused by induction furnaces," *2012 IEEE International Conference on Condition Monitoring and Diagnosis*, pp. 1227-1230, September 2012.