

Fuzzy-Skyhook Controller with Cuckoo Search Algorithm for A Semi-Active Suspension System with Magnetorheological Damper

Mat Hussin Ab Talib*, Muhamad Hakim Helmi Zulkeflee and Hanim Mohd Yatim

School of Mechanical Engineering, Faculty of Engineering
Universiti Teknologi Malaysia
81310 UTM Johor Bahru
Johor, Malaysia

ABSTRACT

This study aims to investigate the performance of a semi-active suspension system of the quarter car using fuzzy-skyhook (fs) controller tuned by cuckoo search algorithm (CSA). Since the parameters of the controller are crucial to be determined, the CSA method is deemed a good approach when combined with the fuzzy-skyhook controller since the proposed controller is expected to improve the searching accuracy of the parameters. The magnetorheological (MR) damper model was developed using the Spencer model approach based on the force-velocity and force-displacement characteristics. Then, a full simulation of the suspension system excited with a sinusoidal road profile input was conducted using MATLAB/Simulink. A comparative study was carried out between the semi-active systems and benchmarked against a passive suspension. The effectiveness of the fuzzy-skyhook controller with CSA (fs-CSA) was analyzed and compared to the fuzzy-skyhook and skyhook controllers. The result indicates that fs-CSA gives the highest percentage of improvement for the body acceleration and displacement for up to 48.6% and 21.3%, respectively.

Keywords: *Cuckoo search algorithm, fuzzy logic, skyhook, magnetorheological damper, semi-active suspension*

1.0 INTRODUCTION

Nowadays, a good safety and comfort in the moving vehicle is very essential since most of the people needs a high quality of life when the vehicle devices such as suspension system is being used. The main purposes of the suspension system are to eliminate vibration that come from any types of road conditions as well as to provide road holding capability to the wheels. A perfect automobile suspension system may absorb road shocks that is produced by the vehicle rapidly and return it to the normal position slowly while maintaining the optimal contact between the tire and the road surface while ensuring the comfort of the passengers in the moving car [1].

There are several types of automotive suspension known as the passive, semi-active and active suspension systems. Each one of them has its own functions between the body and tires. The passive suspension system is designed with fixed values of parameters and it will not be optimal when the system changes. It is the cheapest and simplest suspension but its performance is limited since there is no force damping capability.

*Corresponding email: mathussin@utm.my

Compared to passive suspension, active suspension needs a very high performance in wide frequency. However, it requires major modification needs and high power source, actuators and many sensors. Consequently, by using semi-active suspension system, it can adopt the feature of active suspension in much simpler way as the suspension offers a good performance without using expensive hardware and large power source. In addition, the semi-active suspension system is emerging to be convenient alternatives in promoting as a low cost device and simple structure.

The magneto-rheological (MR) damper is a kind of device due to the controllable interface provided by the MR fluid inside the devices that enables the mechanical device to interact with electronic system. Some examples of devices using MR fluids that have been employed are dampers, clutches, transmission and brakes. Basically, a full vehicle model is preferred for the modeling and investigation of the dynamic behavior of the vehicle suspension system. MR damper is most popular especially for automotive shock absorbers. This is due to the fact that the automotive shock absorber is an important contributor to the ride comfort and road handling of vehicle. However, the roll and pitch behavior may be modeled as an equivalent force disturbance that acts on the mass of every vehicle body. Based on recent research, the success of MR damper in semi-active vehicle suspension applications is determined by two aspects related to accurate modeling of the MR damper and good selection of an appropriate control strategy [2].

The simulation and theoretical research have demonstrated that the performance of the semi-active control system is dependent on the use of effective control strategies. Various controllers were introduced by many researchers in the past few decades such as the skyhook and groundhook controllers [3], fuzzy logic controller [4], PID controller [5] and neural network controller [6]. Among others, the fuzzy logic controller was found to be the most widely used in industrial applications due to the fact that it exhibits strong robustness feature [7]. Other controller like skyhook as introduced by Karnopp is also one of the effective and easy to use techniques [8]. Thus, the hybridization of these two controllers might produce the effective performance of the vehicle system. Previously, Ubaidillah and Jamaluddin presented the combination of the fuzzy logic based and skyhook controllers; its performance has been proven to be better than the conventional skyhook [9]. However, in their research, no fuzzy gain scaling was considered since it is deemed as one of the important parts that needs to be considered in relation to context information [10]. In other words, no amount of gain scaling will affect the performance of the controller since the fuzzy input and output need to be refined in order to obtain the optimum values in relation with the fuzzy rules and membership functions. Thus, an intelligent optimization technique based on a cuckoo search algorithm (CSA) was adopted, proposed and integrated into the fuzzy-skyhook scheme to optimize the gain parameters. The CSA is one of the metaheuristic algorithms, emerging as a good optimizer and able to produce a controller with high performance level.

The intent of this study is to investigate the effect of the fuzzy logic based skyhook controller tuned using the metaheuristic algorithm incorporating the CSA technique in order to improve the vehicle ride comfort of the system. The *Spencer* model was used to represent the MR damper system by exploiting its behavior based on the force-velocity and force-displacement characteristics. The model was selected since it is deemed more accurate and able to represent its behavior for near-zero piston velocity rather than using other parametric modelings. Three semi-active control schemes, namely, the skyhook, fuzzy-skyhook (fs) and fs tuned by CSA (fs-CSA) controllers were investigated and evaluated in time domain simulation using a sinusoidal road profile input and were subsequently benchmarked with a standard passive system.

The rest of this paper is organised as follows; Section 2 focuses on the semi-active modeling complete with the MR damper system followed by the introduction of the fuzzy-skyhook controller and the CSA algorithm in Section 3. Modeling and control of the semi-active suspension system with CSA optimization is also included in this section. Analysis

and discussion based on the simulation results are described in Section 4 and the conclusion is later presented in Section 5.

2.0 SEMI-ACTIVE AND MR DAMPER SYSTEM

The semi-active control system provides both features of passive and active devices in terms of reliability and adaptability. MR damper is a damper controlled by magnetic field usually using an electromagnet and has received great attention from various fields of engineering due to the low manufacturing cost and fast response time. There are a number of modeling works performed on MR dampers in previous research. To better predict the reponse of magnetorheological (MR) damper, Spencer *et al.* proposed an extension of the *Bouc-Wen* model [11]. The model of modified *Bouc-Wen* or called *Spencer* model with the semi-active system is depicted in Figure 1.

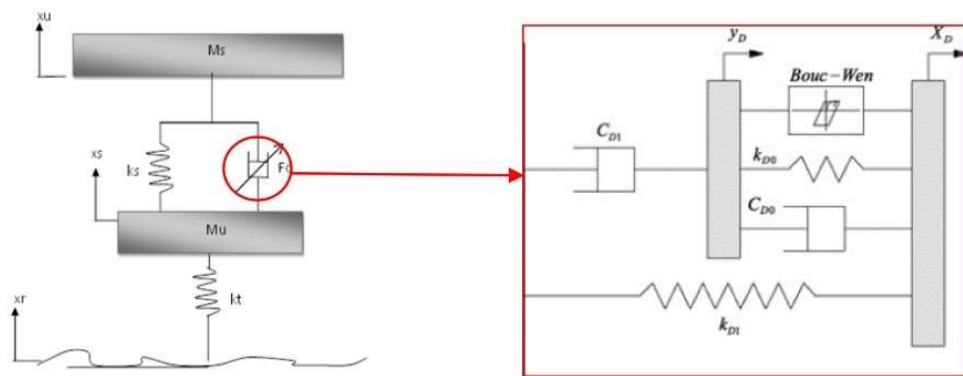

Figure 1: Semi-active system with *Spencer* model

The equations of the force in this model are given by:

$$F_d = C_{D1}\dot{y} + k_{D1}(x_D - x_0) \quad (1)$$

$$\dot{y} = \frac{1}{c_0 + c_{D1}} [\alpha z + c_{D0}\dot{x}_D + k_{D0}(x_D - y_D)] \quad (2)$$

$$\dot{z} = -\gamma|\dot{x}_D - \dot{y}_D|z|z|^{n-1} - \beta(\dot{x}_D - \dot{y}_D)|z|^n + A(\dot{x}_D - \dot{y}_D) \quad (3)$$

where

- | | | |
|-------------------------|---|---------------------------------------------------------------------------------------------------------------|
| F_d | : | damping force |
| C_{D1} and k_{D1} | : | internal damping constant and internal stiffness of accumulators, respectively |
| c_0 | : | viscous damping coefficient |
| c_1 | : | damping coefficient which could induce an attenuation of the restoring force in the range of the low velocity |
| k_0 | : | control stiffness at high velocity |
| x_0 | : | initial displacement of accumulator spring |
| α | : | stiffness parameter |
| γ, β and A | : | constants governing the smoothing of damper force–velocity curves |
| y_D | : | internal displacement |
| x_D | : | damper displacement |
| z | : | hysteretic restoring force |

Generally, the voltage applied to the damper is actually dependent on the current driver from parameters of the *Spencer* model and it can be expressed as follows:

$$\alpha = \alpha_a + \alpha_b u \quad (4)$$

$$c_0 = c_a + c_{0b} u \quad (5)$$

$$c_1 = c_a + c_{1b} u \quad (6)$$

where u represents the output of the first order filter given by:

$$\dot{u} = -\mu(u - v) \quad (7)$$

In the equation, μ and v is the filter time constant and the filter input, respectively. After the MR damper model was derived, the model must be validated to ensure the model gives the nonlinear characteristic resembling the actual MR damper. To validate the model, the parameter of the MR damper was obtained from a reliable source that gives promising result [12]. Next, the velocity input was applied to the model to obtain the behavior of the model. The input applied to the model is in sinusoidal form at 2.5 Hz. the result obtained was compared to the published results for the *Spencer* model. The related parameters used for the *Spencer* model in this study are shown in Table 1. The characteristics of the MR damper behavior in the form of force-velocity and force-displacement relationships are also depicted in Figures 2(a) and (b), respectively. According to these figures, it can be observed that as the voltage is increased, the force required shows a corresponding increase in values and its behavior is as predicted in the previous research done by *Spencer et al.* [11].

Table 1: Parameters for the *Spencer* model [11]

Parameter	Value	Parameter	Value
α_a	462000 N/Vm	k_{DO}	2 N/m
α_b	41200 N/Vm	k_{DO}	9.7 N/m
c_{0a}	110000 Ns/m	A	1107.2 m ⁻¹
c_{0b}	114300 Ns/Vm	β	164 m ⁻¹
c_{1a}	8359200 Ns/m	γ	164 m ⁻²
c_{1b}	7482900 Ns/Vm	η	100
x_0	0	n	2

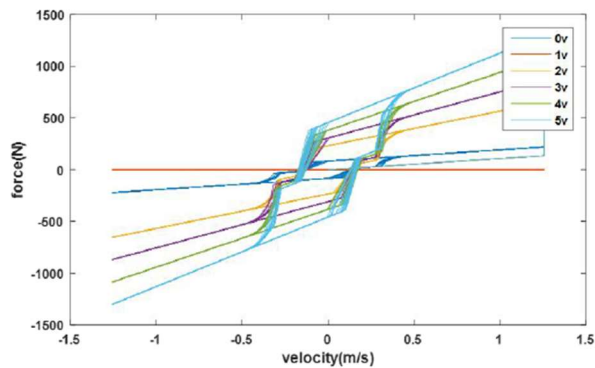

(a)

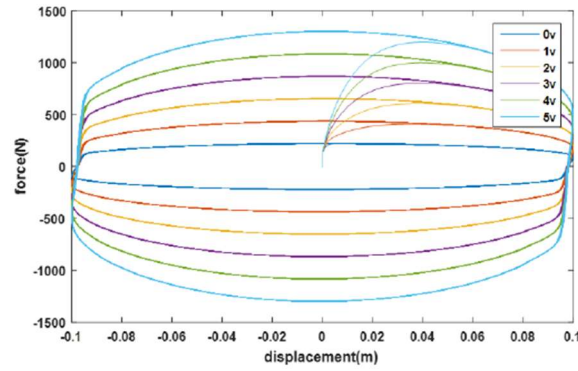

(b)
Figure 2: MR damper behavior for (a) force-velocity and (b) force-displacement characteristics

3.0 CONTROL SYSTEM WITH INTELLIGENT OPTIMIZATION

3.1 Fuzzy Logic Based Skyhook (Fuzzy-Skyhook) Controller

The skyhook controller is a well-known suspension-oriented controller algorithm as a disturbance rejection control. The basic equation for skyhook control is given by:

$$\begin{aligned} F_d &= c_{sky}\dot{x}_s & ; & \text{if } \dot{x}_s v_{rel} > 0 \\ F_d &= 0 & ; & \text{if } \dot{x}_s v_{rel} < 0 \end{aligned} \quad (8)$$

where

- F_d : desired damping force
- c_{sky} : skyhook coefficient
- \dot{x}_s : sprung mass velocity
- v_{rel} : relative velocity between the sprung and unsprung masses

Since, the skyhook coefficient needs a well-tuned condition, the use of fuzzy logic is a good approach in order to produce the optimum coefficient by varying the upper and lower values of the damping skyhook.

Fuzzy-skyhook is a fuzzy based skyhook controller. It does not require a mathematical model since it is a rule-based system. Therefore, it has an advantage over the traditional controller when applied to complex system. It can be developed with a very minimal knowledge about the system dynamic. In this study, the fuzzy logic control was designed to be the sprung mass velocity and relative velocity, as the fuzzy logic inputs and the desired damping constant based skyhook policy as the fuzzy output. There are a number of possible candidates for the shapes representing the membership functions that are most widely used including the *Gaussian*-type, *Bell*-type, hybrid *Gaussian* and *Bell*-type, *triangular*-type, *trapezoidal*-type and hybrid *triangular/trapezoidal*-type. The sensitivity analysis was conducted in order to identify the best type amongst them. Results indicates that the *trapezoidal* membership function was the best candidate and shall be used in the proposed fuzzy logic control scheme. Its membership function is defined as shown in Figure 3.

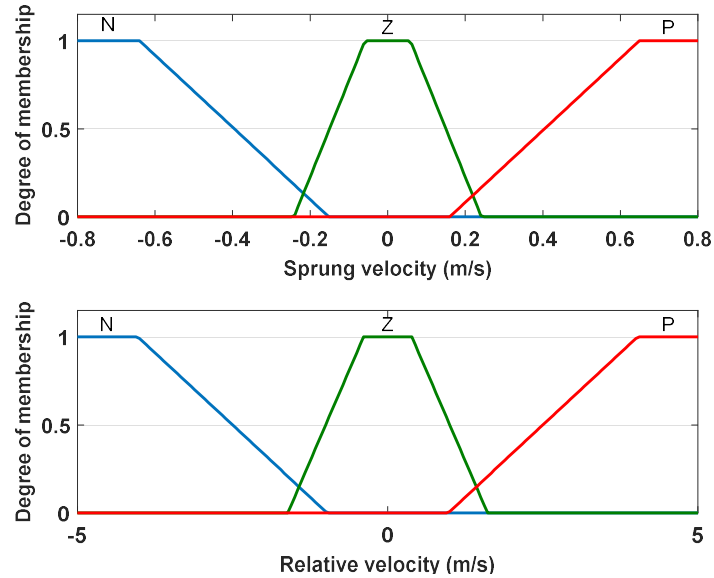

Figure 3: The *trapezoidal* membership functions

The inputs to the fuzzy controller are the sprung mass velocity and relative velocity of unsprung mass and sprung mass. The output of the controller is the damping coefficient which is used to calculate F_d . Both inputs are divided into three sections with the following linguistic variables related to positive (P), zero (Z) and negative (N). The execution of the rule of the controller is developed with generic form of fuzzy if-then rule shown as follows:

if v_s is P and v_{rel} is N then output is C

where v_s and v_{rel} represent the linguistic values for the absolute sprung mass and relative velocities, respectively across the damper. A *Sugeno* type fuzzy rule was used in this study and the prescribed output values were fixed. The values were determined by choosing some damping constant values between the high and low states of damping and the output values are shown in Table 2.

$$V = (C_{\min}, C_{d1}, C_{d2}, C_{d3}, C_{d4}, C_{\max}) \quad (9)$$

Where V is the range of the damping coefficient, C_{\min} is the minimum damping coefficient, C_{d1} , C_{d2} , C_{d3} and C_{d4} , are the damping values in between low and high damping coefficient and C_{\max} is the maximum damping values as shown in Table 2 that were used in the study. The fuzzy rules of the system were also developed. The fuzzy logic controller rule-base for this system is shown in Table 3. Since the output of the fuzzy logic control system is the desired damping coefficient, C_d , the multiplication between C_d and the damper velocity, v_{rel} is required in order to determine the desired damping force, F_d as follows:

$$F_d = C_d v_{rel} \quad (10)$$

Table 2: Fuzzy coefficients

C_{\min}	C_{d1}	C_{d2}	C_{d3}	C_{d4}	C_{\max}
700	3000	6000	9000	12000	15000

Table 3: Fuzzy rules

		Relative Velocity, v_{rel}		
		<i>N</i>	<i>Z</i>	<i>P</i>
Sprung Velocity, v_s	<i>N</i>	C_{max}	C_{d3}	C_{min}
	<i>Z</i>	C_{d4}	C_{d2}	C_{d1}
	<i>P</i>	C_{min}	C_{d2}	C_{max}

Two scaling factors which are the gain sprung velocity (*GSV*) and gain relative velocity (*GRI*) were incorporated into expressions for the sprung velocity input and the relative velocity input of the controller, respectively, while the gain coefficient (*GC*) is associated with the variable coefficient control output for improvement purpose. The selection for the evaluation of the fuzzy-skyhook gain scaling was optimized using the CSA strategy based on the lowest MSE value that will be elaborated in the next sub-section.

3.2 Cuckoo Search Algorithm (CSA)

CSA is one of the evolutionary algorithm that has been introduced and patented by Yang and Deb [13]. This algorithm is inspired based on the interesting breeding behavior such as brood parasitism of certain species of cuckoos [14]. The basic steps of cuckoo search behavior have been summarized as a pseudo code shown in Figure 4. There are three idealized rules introduced by Yang and Deb when applied is popularly known as the Cuckoo Search Algorithm (CSA) described as follows [13]:

- Each cuckoo lays one egg at a time, and dumps its egg in randomly chosen nest.
- The best nests with high quality of eggs will carry over to the next generations.
- The number of available host nests is fixed, and the egg laid by a cuckoo is discovered by the host bird with a probability $pa \in [0, 1]$.

The host bird can destroy them or abandon its nest, if the host bird discovered the cuckoo's eggs. In the two scenarios, a new nest will be developed with the probability P_a for a fixed number of nests. The gene of the nest can be expressed as the cell or nucleus and is stored as (R_p, I_p) ; R_p, I_p express, respectively, the real and imaginary parts of the variable. Later, the i th nest can be expressed as shown in Table 4 while the pseudo code of the CSA optimization technique is depicted in Figure 4. The flow chart of the CSA process and how it is adopted into the proposed controller is also described in Figure 5.

Table 4: Nest chromosome structure [12]

(R_{p1}, I_{p1})	(R_{p2}, I_{p2})	...	(R_{pM}, I_{pM})
--------------------	--------------------	-----	--------------------

```

begin
  Objective function  $f(\mathbf{x})$ ,  $\mathbf{x} = (x_1, \dots, x_d)^T$ 
  Generate initial population of
     $n$  host nests  $\mathbf{x}_i$  ( $i = 1, 2, \dots, n$ )
  while ( $t < \text{MaxGeneration}$ ) or (stop criterion)
    Get a cuckoo randomly by Lévy flights
    evaluate its quality/fitness  $F_i$ 
    Choose a nest among  $n$  (say,  $j$ ) randomly
    if ( $F_i > F_j$ ),
      replace  $j$  by the new solution;
    end
    A fraction ( $p_a$ ) of worse nests
      are abandoned and new ones are built;
    Keep the best solutions
      (or nests with quality solutions);
    Rank the solutions and find the current best
  end while
  Postprocess results and visualization
end

```

Figure 4: Pseudo code of the CSA

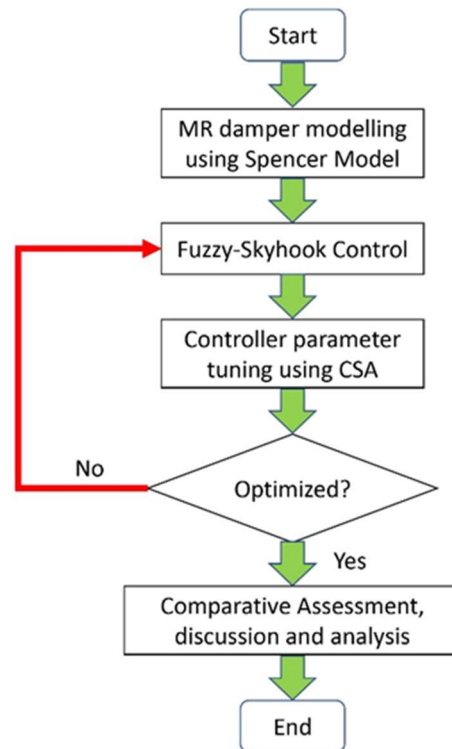

Figure 5: Flow of the CSA

The CSA parameters in this study were set as 25 number of nests, 100 iterations and the lower and upper boundaries were limited to 0.01 and 10, respectively. Full simulation of the semi-active suspension model adopting the CSA strategy into the fuzzy-skyhook control system is shown in Figure 6. The performances of the CSA in optimizing the gain scaling parameters and the final optimum values are also shown in Figure 6 and Table 5. Referring to Figure 7, it is worth mentioning that the optimum gain values were obtained when the number of iterations was around 60. The particle of cuckoo search has an optimum target based on the said iteration and the objective function of the CSA was found to remain converged until the maximum number of iterations. Thus, the optimum values of the gain scaling were used for the proposed controller for improvement purpose.

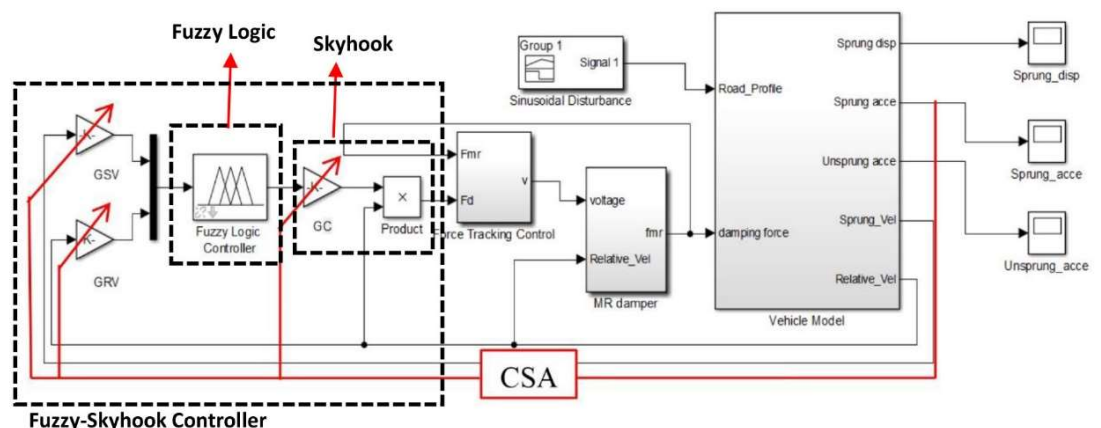

Figure 6: The fs-CSA control design

Table 5: Gain parameters result tuned using CSA method

Gain	Value
<i>GSV</i>	4.998
<i>GRV</i>	4.996
<i>GC</i>	4.862

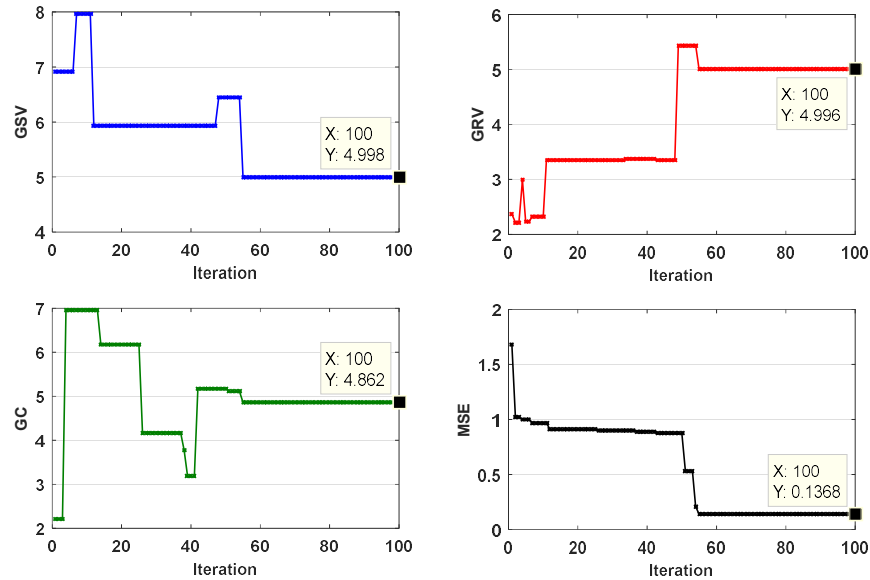

Figure 7: Gain scale for sinusoidal input

4.0 ANALYSIS AND DISCUSSION

The effectiveness of the fuzzy-skyhook with the CSA computation to track the input of the desired force was investigated in time domain. The MSE and percentage error of the proposed controllers including the desired force are listed in Table 6 for four different control schemes, namely, the passive, skyhook, fuzzy-skyhook and fs-CSA. The percentage improvement of the MSE values for all schemes were compared to the passive suspension system based on the output values.

Based on the table, the fs-CSA has the lowest MSE and highest percentage of improvement (up to 48.6%) for all parameters of interest compared to the passive suspension. This proves the capability of the intelligent algorithm to optimize the fuzzy-skyhook parameter and hence it is well-founded. Furthermore, the fuzzy-skyhook controller outclasses the skyhook controller significantly while the skyhook scheme made the least improvement for all parameters.

The graphs for comparing the amplitude and overshoot for each parameter of interest for a sinusoidal input are shown in Figures 8 and 9. With reference to these graphs, it is noteworthy to mention that the fs-CSA is able to reduce the sprung mass displacement and sprung mass acceleration amplitude when the system was excited with the sinusoidal road profile input. The use of the CSA method as an intelligent tuning method demonstrates that it is able to improve the controller performance significantly and graphical results also imply that it performs better than the fuzzy-skyhook and skyhook controllers' counterpart.

Table 6: MSE and percentage error for a sinusoidal input

Index	Passive	Skyhook	Fuzzy-Skyhook	fs-CSA
Sprung mass acceleration (m/s^2)	0.2661 (benchmark)	0.1991 (25%)	0.1898 (28.7%)	0.1368 (48.6%)
Sprung mass displacement (m)	3.89×10^{-4} (benchmark)	3.74×10^{-4} (3.9%)	3.64×10^{-4} (6.4%)	3.06×10^{-4} (21.3%)

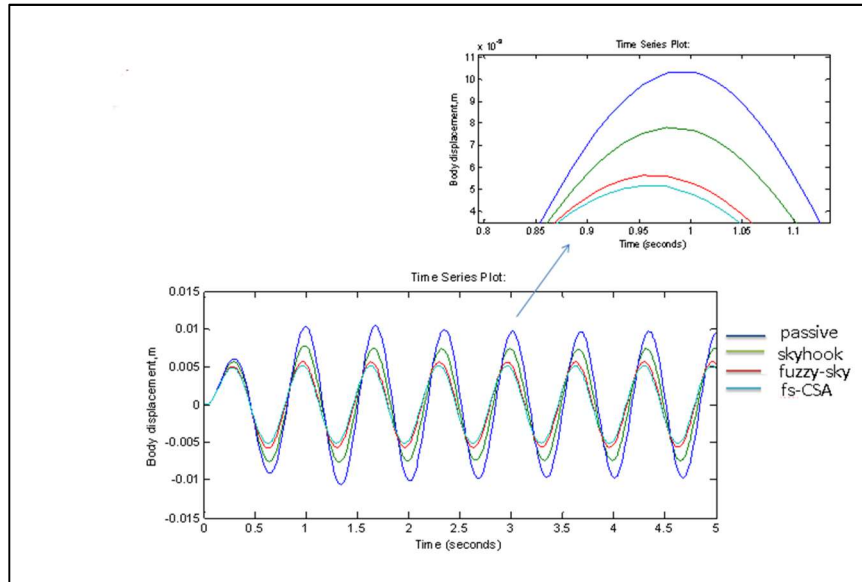

Figure 8: Body displacement over time

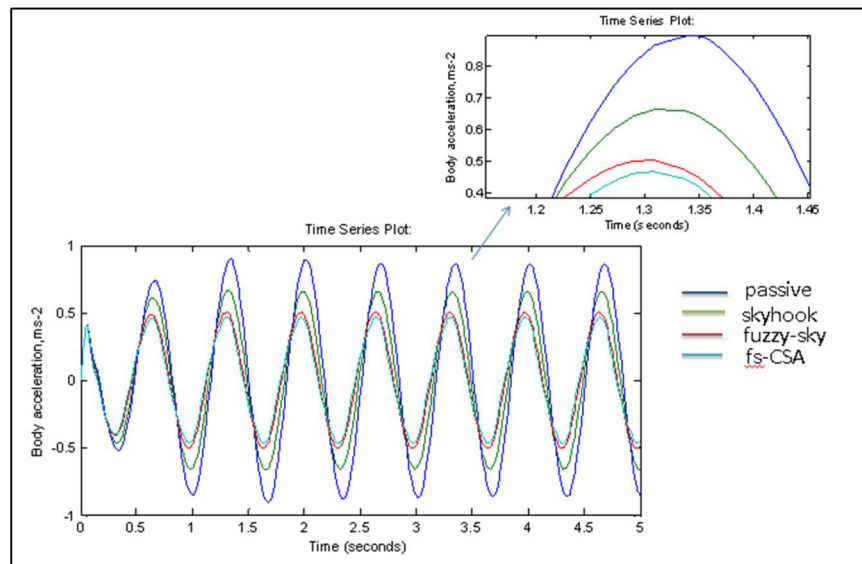

Figure 9: Body acceleration over time

5.0 CONCLUSION

An intelligent optimization method based on CSA technique used to tune the fuzzy-skyhook gain scaling is presented. The CSA has proven its capability to exhibit a global performance outcome and shown to be very effective when solving a high nonlinear problem. When the vehicle was excited with a sinusoidal input, the percentage

improvement achieved by fs-CSA is 21.3% and 48.6% for the body (sprung mass) displacement and acceleration, respectively. It is worth mentioning that the fs-CSA performs well and better compared to the fuzzy-skyhook controller without gain scaling since the fuzzy-skyhook itself has a limited control capability and this factor in turn leads to diminished or limited accuracy. Thus, by adding the gain scaling component and tuning with the proposed intelligent method using CSA, this kind of problem can be overcome and it will further stabilize the system.

ACKNOWLEDGMENTS

The authors would like to express their gratitude to the Minister of Education (MOE) Malaysia and Universiti Teknologi Malaysia (UTM) for funding and providing the facilities to conduct this research. This research is supported using UTM Research University Grant, Vote No.: 03K30.

REFERENCES

1. Tudon-Martinez J.C., Hernandez-Alcantara D., Sename O., Morales-Menendez R., and Lozoya-Santos J. de J., 2018. Parameter-Dependent H_∞ Filter for LPV Semi-Active Suspension Systems, *IFAC-PapersOnLine*, 51(26): 19–24.
2. C. Graczykowski and Pawłowski P., 2017. Exact Physical Model of Magnetorheological Damper, *Applied Mathematical Modelling*, 47: 400–424.
3. Allauddin A., Rajendra D. and Jalwadi S.N., 2014. Performance Analysis of Skyhook, Groundhook and Hybrid Control Strategies on Semiactive Suspension System, *International Journal Current Engineering and Technology*, 3: 7–10.
4. Pang H., Liu F. and Xu Z., 2018. Variable Universe Fuzzy Control for Vehicle Semi-active Suspension System with MR Damper Combining Fuzzy Neural Network and Particle Swarm Optimization, *Neurocomputing*, 306: 130–140.
5. Nagarkar M., Bhalerao Y., Patil G.V. and Patil R.Z., 2018. Multi-Objective Optimization of Nonlinear Quarter Car Suspension System - PID and LQR Control, *Procedia Manufacturing*, 20: 420–427.
6. Guo D.L., Hu H.Y. and Yi J.Q., 2004. Neural Network Control for a Semi-Active Vehicle, *Journal of Vibration and Control*, 10: 461–471.
7. Talib M.H.A. and Mat Darius I.Z., 2014. Development of Fuzzy Logic Controller by Particle Swarm Optimization Algorithm for Semi-active Suspension System Using Magnetorheological Damper, *WSEAS Transaction System and Control*, 9(1): 77-85.
8. Hong K.S., Sohn H.C. and Hedrick J.K., 2002. Modified Skyhook Control of Semi-Active Suspensions: A New Model, Gain Scheduling, and Hardware-in-the-Loop Tuning, *Journal of Dynamic System, Measurement, and Control*, 124(1): 158.
9. Ubaidillah K.H. and Jamaluddin H., 2011. Simulation and Experimental Evaluation on A Skyhook Policy-based Fuzzy Logic Control for Semi-active Suspension System, *International Journal of Structural Engineering*, 2(3): 243–272.
10. Magdalena L., 1997. Adapting the Gain of An FLC with Genetic Algorithms, *International Journal of Approximate Reasoning*, 17(4): 327–349.
11. Spencer B.F., Dyke S.J., Sain M.K. and Carlson J.D., 1997. Phenomenological Model of A Magnetorheological Damper, *Journal of Engineering Mechanical*, 1–23.
12. Azar B.F., Rahbari N.M. and Talatahari S., 2011. Seismic Mitigation of Tall Building Using Magnetorheological Dampers, *Asian J. Civ. Eng.*, 12(5): 637–649.
13. Yang X.-S. and Deb S., 2010. Engineering Optimisation by Cuckoo Search, *International Journal of Mathematical Modeling and Numerical Optimization*, 1(4): 330–343.
14. Yang X.S. and Deb S., 2009. Cuckoo Search via Levy Flights, *Procs. of World Congress on Nature & Biologically Inspired Computing (NaBIC 2009)*, 210–214.