



Inhibitory Effects of *Swietenia Mahagoni* Seeds Extract on A-Glucosidase and A-Amylase

N. S. Md Norodin^{a,b}, L. Md Salleh^{*a,b}, N. Yusof^c, N. M. Mustapha^d, F. Kamarulzaman^d, M. A. Mohamed Zahari^{a,b}, N. A. Bakeri^{a,b}

^a Center of Lipids Engineering and Applied Research (CLEAR), Ibnu Sina Institute Scientific & Industrial Research (Ibnu Sina ISIR), Universiti Teknologi Malaysia, Johor, Malaysia

^b Department of Bioprocess and Polymer Engineering, School of Chemical and Energy Engineering, University Teknologi Malaysia, Johor, Malaysia

^c Advanced Membrane Technology Research Centre (AMTEC), Universiti Teknologi Malaysia, Skudai, Johor, Malaysia

^d Natural Product Division, Forest Research Institute Malaysia (FRIM), Selangor Darul Ehsan, Malaysia

PAPER INFO

Paper history:

Received 16 December 2017

Received in revised form 25 January 2018

Accepted 08 February 2018

Keywords:

Swietenia Mahagoni Seed,
A-Glucosidase Enzyme,
A-Amylase Enzyme,
Supercritical Carbon Dioxide (SC-CO₂)
Extraction

ABSTRACT

This study analyzed the inhibition activity of *Swietenia mahagoni* seeds extract on α -glucosidase and α -amylase enzymes inhibition assays. *Swietenia mahagoni* seeds were extracted by using supercritical carbon dioxide (SC-CO₂) extraction at pressures of 20- 30 MPa and temperatures of 40- 60°C. The oil yields obtained were analyzed with α - glucosidase and α - amylase enzymes inhibition assays. All data obtained were expressed as mean \pm standard deviation for triplicate experiments. One way analysis was used for statistical significance by using statistica software version 7.0 (StartSoft, EUA) and IC₅₀ (extract concentration causing 50% enzyme inhibitory) was determined by using GraphPad Prism 6.0 software. *Swietenia mahagoni* seeds extract have a strong inhibition of α -glucosidase enzyme activity (98.4% \pm 0.2) but a moderate inhibition of α - amylase enzyme activity (34.9% \pm 1.2). These findings implied that *Swietenia mahagoni* seeds extract could be an effective natural antidiabetic agent.

doi: 10.5829/ije.2018.31.08b.20

1. INTRODUCTION

Currently, 117 million diabetes cases were reported and expected to rise to 336 million by the end of 2030 [1]. Diabetes is a prevalent disease depict by distorted glucose level in blood also known as hyperglycemia [2]. Hyperglycemia can be depict by the disorder of β -cells, insulin inadequacy and distorted glucose level in blood [3]. In managing diabetes mellitus, one of efficacious way is to delay the glucose level and to achieve this is by the inhibition of carbohydrate-digesting enzymes such as α -glucosidase and α -amylase [2]. In the final digestive process, α -glucosidase act as vital enzyme in catalyzing the disaccharides and oligosaccharides into glucose [4]. Meanwhile, α -amylase imply in catalyzing starch to disaccharides and oligosaccharides. Thus, α -glucosidase and α -amylase inhibitors can be used to

delay the release of d-glucose from carbohydrate which also delaying the absorption of glucose in the small intestine [5, 6]. Hence, reducing the glucose level in blood and repression of postprandial hyperglycemia (PPHG). By retaining the reduction of hyperglycemia, risk of developing microvascular and macrovascular complications can be reduce [7].

According to World Health Organization (WHO), approximately 80% of world population prefer traditional medicine rather than modern approach. Relatable, synthetic oral antidiabetic agents such as acarbose was reported with side effect and failure to reduce diabetes complications [8]. Therefore, interest for natural oral antidiabetic agent from medicinal plants is in demand. *Swietenia mahagoni* also known locally as 'tunjuk langit' in Malaysia is used traditionally to treat various diseases such as diabetes and high blood pressure [9]. *S. mahagoni* seeds also reported to have various biological activities such as anti-inflammatory

*Corresponding Author Email: i.liza@cheme.utm.my (L. Md Salleh)

activity, anticancer and antitumor activity [10] and also antidiabetic activity [11]. In Malaysia, the raw seeds have been used for hypertension and diabetes [12]. Previous research on *S. mahagoni* seeds had proven the antidiabetic activity as shown in Table 1.

As summarized in Table 1, conventional methods of extraction were used for the antidiabetic study *in vivo* and *in vitro* diabetic model. Limited study on antidiabetic study using advance extraction method such as supercritical carbon dioxide (SC-CO₂) extraction for *S. mahagoni* was studied. SC-CO₂ extraction is a separation process of matters by using supercritical carbon dioxide as solvent. Carbon dioxide is the most frequent solvent used that is an environmentally friendly (fairly non-toxic), low cost and can easily been removed from the extract [13]. Moreover, the extraction rate of SC-CO₂ can be easily manipulated or controlled by pressure and temperature which also influence the solvency power [14]. Also, by using SC-CO₂ extraction, degradation of thermolabile compounds are prevented due to the reduced operating temperature in the extraction [15].

Moreover, quantification of β -sitosterol was determined and the correlation of β -sitosterol and the inhibitory activities of α -glucosidase and α -amylase were evaluated. β -sitosterol (Figure 1) is one of the diversified group of compounds in phytosterols. Phytosterols are well known as plant sterols, one of the vital components of plant membranes [16]. The most ample compound in natural sterols is β -sitosterol [17] and it can be found in seeds, nuts, vegetables and fruits. Furthermore, β -sitosterol have been reported to have various pharmacological activities such as anti-inflammatory activity [18], chemopreventive effects [19], hypocholesterolemic activity [20], antioxidant effects [21] and also antidiabetic effects [22]. Previous study had shown that β -sitosterol may responsible to the antidiabetic activity shown in Table 2.

In this study, the aim is to evaluate the antidiabetic activity of *Swietenia mahagoni* seed extract from SC-CO₂ extraction. The antidiabetic activity of *S. mahagoni* seeds extract was analyzed by *in vitro* diabetic model (inhibition of carbohydrate-digesting enzymes). Moreover, the correlation of β -sitosterol and the inhibitory activities of α -glucosidase and α -amylase were also evaluated.

2. EXPERIMENTAL

2.1. Materials Commercial grade liquid carbon dioxide (purity 99.99%) used in supercritical carbon dioxide extraction was purchased from Kras, Instrument

and Services, Johor, Malaysia. Acarbose, 1-deoxynojirimycin, p-nitrophenyl- α -D-glucopyranoside (pNPG), sodium dihydrogen phosphate, sodium phosphate tartrate, disodium hydrogen phosphate, sodium hydroxide, dimethyl sulfoxide (DMSO), potassium chloride, 3,5-dinitrosalicylic acid (DNS), starch (soluble), α -amylase from porcine pancreas and α -glucosidase from *Saccharomyces cerevisiae* supplied by Sigma-Aldrich (St. Louis MO, USA). Sodium chloride (Bendosen Laboratory Chemicals, Bendosen, Norway. Potassium phosphate monobasic supplied by Merck, Millipore, Billerica, (Massachusetts, USA).

2.2. Sample Preparation of *Swietenia Mahagoni* Seeds

Swietenia mahagoni seeds were bought in the local market. The seeds were rinsed with tap water to remove any foreign particles and dirt prior to drying. Then, the cleaned seeds were cut into small pieces and dried by using oven at temperature of 50°C for a week to remove moistures. The seeds were ground by using a blender (Merck, Panasonic) and sieved to approximate 0.50 mm of particle size.

2.3. Supercritical Carbon dioxide (SC-CO₂) extraction

Clear supercritical fluid extraction (SFE) machine in Center of Lipids Engineering and Applied Research (CLEAR), Universiti Teknologi Malaysia consisted of CO₂ gas cylinder, CO₂ controller pump (Lab Alliance), co-solvent pump (Lab Alliance), oven (Mettler, Germany), 10 ml stainless steel extraction vessel, pressure gauge (Swagelockk, Germany), automatic back pressure regulator (Jasco BP 2080- Plus) and restrictor valve. A schematic diagram of CLEAR SFE apparatus is illustrated in Figure 2.

The parameters and constant parameters used in extraction process are presented in Table 3. Five gram of sample was placed in 10 ml stainless steel extraction vessel and sealed tightly in the oven. Set all the parameters (temperature, pressure and flowrate of CO₂), the extraction process started after all the parameters were attained. Lastly, depressurized the system and the oil yields were collected after 120 minute extraction time.

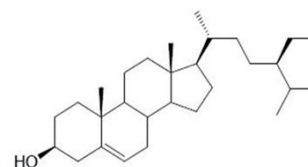

Figure 1. Structure of β -sitosterol [17]

TABLE 1. Summary of studies on antidiabetic effects of Swietenia Mahagoni

Experimental Model (<i>In vitro</i>)	Extraction method	Results	Suggested mechanism(s) of action	Reference
<i>In vitro</i> studies				
<i>In vitro</i> bioassay (glucose utilization assay)	Chloroform	Exhibited a significant improvement ($p < 0.005$) of peripheral glucose utilization	Insulin mimetic	[23]
<i>In vitro</i> glucose absorption by isolated everted intestine	Petroleum ether	Did not significantly inhibit glucose absorption through everted intestinal	NA*	[24]
<i>In vitro</i> α -amylase inhibitory activity	Petroleum ether	Showed the highest inhibitory activity, measured 86.81 percent inhibition	Inhibition of digestive enzyme activities	[25]
<i>In vitro</i> (non-cell based enzymatic assay)	Ethanollic	Showed the highest inhibitory activity, measured 18.647 percent inhibition	Inhibition of digestive enzyme activities	[6]

NA = Not available

TABLE 2. Summary of studies on antidiabetic effects of β -sitosterol

Experimental Model	Results	Suggested mechanism(s) of action	Reference
<i>In vivo</i> studies			
Streptozotocin-induced diabetic rats	Decreases in glycated hemoglobin, serum glucose, and nitric oxide, with concomitant increases in serum insulin levels	Insulin mimetic and β -cell regeneration	[22]
Alloxan-induced diabetic mice	Lowered the serum glucose level in diabetic mice	Decrease glucose production at liver	[26]

TABLE 3. The process parameters for SC-CO₂ extraction

Parameter	Range/ value
Temperature (°C)	40-60
Pressure (MPa)	20-30
Flowrate of CO ₂ (ml/min)	2.00
Particle size (mm)	0.50
Mass of sample (g)	5.00
Extraction time (min)	120

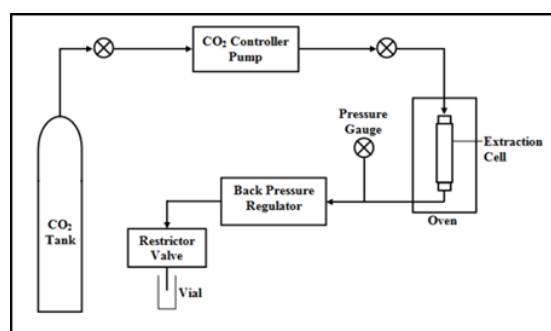
**Figure 2.** Schematic diagram of CLEAR supercritical fluid extraction (SFE) machine

Collected oil yield was calculated as percentage of oil yield by using equation below:

$$\text{OilYield}(\%) = \left(\frac{M_1}{M_2} \right) \times 100 \quad (1)$$

Where, M_1 is the mass of oil extract in gram and M_2 is the mass of the sample in gram.

2. 4. High Performance Liquid Chromatography (HPLC) Analysis

β -sitosterol was analyzed [27] with a slight modification by using a Waters HPLC system (Milford, MA, USA) consisting of a pump and system controller (Model Waters e2695) and photodiode array detector (Model 2998). The compound separation was carried out by a C18 reserved phase Kinetex Biphenyl column (5 μ m, 4.6 \times 150 mm) with a flow rate of 1.0 ml/min. The mobile phase was consisted of Methanol (60%)/ Acetonitrile (40%), in an isocratic program. The injection volume is 20 μ L. All samples were filtered with 0.45 μ m nylon filters prior to injection. The detection was monitored at 210 nm and data were integrated by Empower 3 software (Waters) (Milford, MA, USA). Figure 3 shows the calibration curve for β -sitosterol and the equation obtained was used to calculate the β -sitosterol content in each extracts.

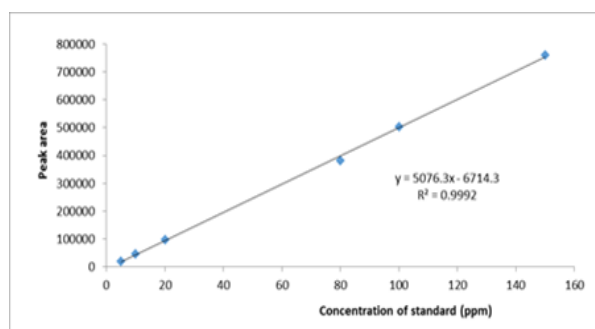

Figure 3. Calibration curve of β -sitosterol

2. 5. α -glucosidase Inhibition Assay α -glucosidase inhibition activity was determined following previous methods [28-30] with modifications. 10 μ L of sample with various concentrations (0- 100 μ g/ml), acarbose (positive control) and DMSO (negative control) were transferred to 96-well plate (Greiner Bio-one) using micropipettes (Eppendorf, ResearchPlus). After that, 20 μ L of α -glucosidase, 40 μ L of phosphate buffer saline (PBS) pH 6.5 and 20 μ L of distilled water were pipetted into each wells and incubated at 37°C for 10 minutes (pre-incubation) by using thermo-shaker incubator (Allsheng, MSC-100). Next, 10 μ L of pNPG was added into all wells in dark and immediately the first absorbance was read at 405 nm (A^0 min) using spectrophotometer (BMG, FLUOstar Omega). Then, the plate was incubated at 37°C for 30 minutes and the absorbance was read again at 405 nm (A^{30} min). Final reaction mixture contain 0.1 U/mL enzyme and 1.25 mM pNPG substrate. Inhibition of α -glucosidase (%) was calculated using equation below:

$$\text{Inhibition}(\%) = \left(\frac{A^{\text{Control}} - A^{\text{Sample}}}{A^{\text{Control}}} \right) \times 100 \quad (2)$$

where A is the absorbance of test mixture of wavelength of 405 nm.

2. 6. α -amylase Inhibition Assay α -amylase inhibition activity was determined following previous methods [28, 31, 32] with modifications. 10 μ L of sample, acarbose (positive control) and 5% DMSO (negative control) were transfer to test and blank well in 96-well plate (Greiner Bio-one) using micropipettes (Eppendorf, ResearchPlus). After that, 50 μ L of α -amylase solution (4.0 U/mL) and 40 μ L of distilled water were added into each wells (add 90 μ L of distilled water at blank wells) and the plate was incubated at 25°C for 5 minutes (pre-incubation) by using thermo-shaker incubator (Allsheng, MSC-100). Then, 100 μ L of starch (0.5 % w/v) solution was added into every wells and incubated at 25°C for 7 minutes. Next, 100 μ L of DNS color solution was added into all wells in dark and incubate at 85°C for 30 minutes. The plate was allowed to cool to room temperature before measuring the

absorbance at 540 nm. Final reaction mixture contain 100 μ g/mL sample, 1.0 U/mL enzyme and 0.25% w/v starch. Inhibition of α -amylase (%) was calculated by using equation below:

$$\text{Inhibition}(\%) = \left(\frac{A^{\text{Control}} - A^{\text{Sample}}}{A^{\text{Control}}} \right) \times 100 \quad (3)$$

where A is the absorbance of test mixture of wavelength of 540 nm.

2. 7. Statistical Analysis Data obtained were expressed as mean \pm SEM from triplicate experiments. One-way analysis of variance was used to test for statistical significance between means using Statistica software version 7.0 (StatSoft, EUA) and IC_{50} (extract concentration causing 50% enzyme inhibitory) was determined using GraphPad Prism 6.0 software. $p < 0.01$ and $p < 0.05$ were considered as significant. The Pearson correlation test was performed to obtain correlation value (r) between β -sitosterol concentration and α -glucosidase and α -amylase inhibition.

3. RESULTS AND DISCUSSION

3. 1. Supercritical Carbon Dioxide (SC-CO₂) Extraction

The extraction of the essential oil of *Swietenia mahagoni* seeds by using SC-CO₂ extraction showed that the highest yield (14.45 %) obtained was at the maximum level (30MPa, 60°C) meanwhile lowest (1.49%) at (20MPa, 60°C) as shown in Table 4. At high temperature, the decomposition of cell walls occurred thus extracted oil produced is also high [33]. Operating at higher pressure will influence the solvent density, thus enhanced the solvency power (the interaction of inter-molecules and solutes increase) [34]. Similar result was reported in the extraction of the essential oil of *Swietenia mahagoni* seeds using SC-CO₂ extraction [35].

TABLE 4. Extraction of the essential oil of *Swietenia mahagoni* seeds at different conditions (pressure, P and temperature, T)

Condition (s)	Oil yield (%)
P= 20MPa, T= 40°C	6.56
P= 20MPa, T= 50°C	3.68
P= 20MPa, T= 60°C	1.49
P= 25MPa, T= 40°C	6.64
P= 25MPa, T= 50°C	4.95
P= 25MPa, T= 60°C	4.56
P= 30MPa, T= 40°C	7.02
P= 30MPa, T= 50°C	8.61
P= 30MPa, T= 60°C	14.45

3. 2. Quantification of β -sitosterol Content β -sitosterol content of *S. mahagoni* seeds extract at different conditions in SC-CO₂ extraction were identified and quantified. The highest β -sitosterol obtained was 9.20 mg/g at 30 MPa and 40°C meanwhile the lowest (3.12 mg/g) was obtained at 20 MPa and 50°C as summarized in Table 5.

β -sitosterol is a non-polar compound [36] and supercritical carbon dioxide (SC-CO₂) extraction is more appropriate to extract non-polar nature compounds [37] than solvent extraction. From Table 5, the highest yield of β -sitosterol was obtained at the lowest temperature studied. This shows that the domination of solute vapor pressure at low temperature [38]. Meanwhile at high pressure, the recovery of β -sitosterol was higher. This result also accordance with previous research in the extraction of β -sitosterol by using SC-CO₂ extraction [39-42]. It shows that the increase of SC-CO₂ density cause the increase in the solubility of β -sitosterol in SC-CO₂. Figures 4 and 5 show the HPLC chromatograms of the standard (β -sitosterol) at concentration of 80 ppm and β -sitosterol compound detected in *S. mahagoni* oil extract accordingly.

TABLE 4. Extraction of the essential oil of *Swietenia mahagoni* seeds at different conditions (pressure, P and temperature, T)

Condition (s)	B-sitosterol content (mg/g)
P= 20MPa, T= 40°C	3.52
P= 20MPa, T= 50°C	3.12
P= 20MPa, T= 60°C	5.91
P= 25MPa, T= 40°C	7.03
P= 25MPa, T= 50°C	6.23
P= 25MPa, T= 60°C	8.72
P= 30MPa, T= 40°C	9.20
P= 30MPa, T= 50°C	3.67
P= 30MPa, T= 60°C	6.70

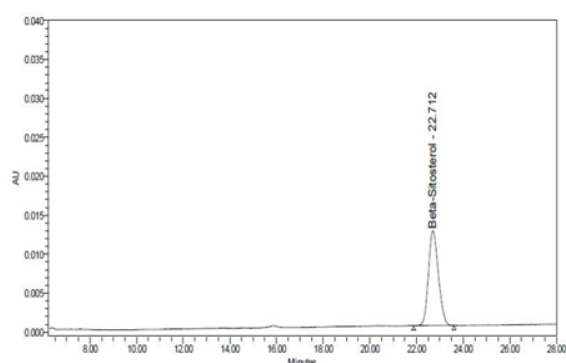

Figure 4. HPLC chromatography of the standard (β -sitosterol) at concentration of 80 ppm.

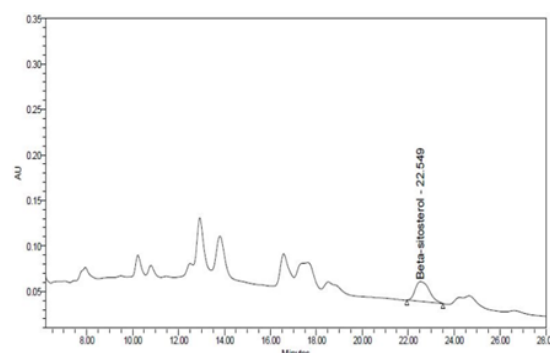

Figure 5. HPLC chromatogram of β -sitosterol compound detected in *S. mahagoni* oil extract at 30 MPa and 40°C.

3. 3. α -glucosidase activity Inhibitory activity of α -glucosidase from *S. mahagoni* seeds extract at different condition is shown in Table 6. All conditions achieved IC₅₀ value (extract concentration causing 50% enzyme inhibitory). The stronger the α -glucosidase inhibitory activity, the lowest the IC₅₀. In this study, the lowest IC₅₀ value achieved was $11.92 \pm 0.23 \mu\text{g/mL}$ ($p < 0.01$) at 20 MPa and 60°C and the highest IC₅₀ achieved was $39.62 \pm 2.95 \mu\text{g/mL}$ ($p < 0.05$) at 25 MPa and 50°C. Currently, no studies were found for different conditions of SC-CO₂ extraction on inhibitory activity of carbohydrate-digesting enzymes.

Previous research on α -glucosidase inhibitory activity of *S. mahagoni* is shown in Table 7 with comparison with the result in this study. It shows that by using SC-CO₂ extraction, the percent inhibition is much higher than using conventional methods. This may due to the reduced operating temperature in the SC-CO₂ extraction that prevent the degradation of thermolabile [15]. Despite the fact that conventional extraction methods with solvents could achieve the target, but during elimination of solvent, oxidative deteriorations may occur [43]. This may resulting in the low percent inhibition of α -glucosidase activity using the conventional methods mention in Table 7.

Moreover, effect of pressure and temperature of SC-CO₂ also affect on α -glucosidase inhibitory activity. Figure 6 shows the effect of pressure and temperature on IC₅₀ of α -glucosidase inhibitory activity. The evaluation for the effect of temperature toward α -glucosidase inhibitory activity showed that at constant pressure of 20, 25 and 30 MPa, the IC₅₀ value increases as temperature increase from 40 to 50°C and decrease as its reached 60°C. This is because as temperature further increase, the recovery of compound responsible to the inhibitory activity of α -glucosidase may decrease due to vaporization or decomposition of the volatile compound during the extraction.

TABLE 6. IC₅₀ data of α -glucosidase inhibitory activity of *S. mahagoni* seeds extract at different conditions (pressure, P and temperature, T). The values presented are expressed as mean \pm standard error of the mean of triplicate experiments

Condition (s)	IC ₅₀ (μ g/mL)
Positive control	62.45 \pm 1.79
P= 20MPa, T= 40°C	31.11 \pm 2.25**
P= 20MPa, T= 50°C	34.55 \pm 2.61**
P= 20MPa, T= 60°C	11.92 \pm 0.23*
P= 25MPa, T= 40°C	27.53 \pm 2.07*
P= 25MPa, T= 50°C	39.62 \pm 2.95**
P= 25MPa, T= 60°C	13.9 \pm 0.33*
P= 30MPa, T= 40°C	17.56 \pm 0.19*
P= 30MPa, T= 50°C	34.70 \pm 1.15**
P= 30MPa, T= 60°C	19.28 \pm 1.13*

* $p < 0.01$ as compared with positive control

** $p < 0.05$ as compared with positive control

TABLE 7. Comparison of extraction methods on % inhibitory activity of α -glucosidase inhibitory from *S. mahagoni* seeds extract at concentration of 100 μ g/ml.

<i>Swietenia mahagoni</i> seeds extraction method	% Inhibition	Reference
Aqueous maceration	4.376 \pm 0.192	[6]
Ethanol maceration	18.647 \pm 3.86	
Aqueous reflux	5.309 \pm 0.514	This study
Ethanol reflux	14.313 \pm 3.522	
SC-CO ₂	93.773 \pm 1.306	

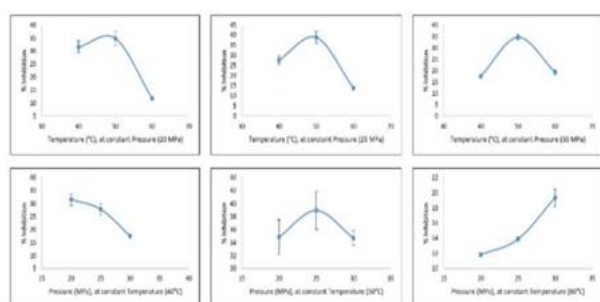

Figure 6. The effect of pressure and temperature on IC₅₀ of α -glucosidase inhibitory activity

Next, at constant temperature of 40°C shows decreasing IC₅₀ of α -glucosidase inhibitory activity. As mentioned, the stronger the α -glucosidase inhibitory activity, the lowest IC₅₀. At low temperature, the degradation of compounds can be avoided. Meanwhile at constant temperature of 50°C, the IC₅₀ value increases

as pressure increase from 20 to 25 MPa and decrease as it reached 30 MPa. Lastly, at constant temperature of 60°C, as pressure increases, the IC₅₀ value increases. In this study, β -sitosterol in the extract was quantified by high performance liquid chromatography (HPLC). The correlation of β -sitosterol content and α -glucosidase inhibitory activity was studied and shown in Figure 7.

From Figure 7, the β -sitosterol concentration in extracts showed a negative correlation toward the activity of α -glucosidase at constant pressure of 20, 25 and 30 MPa. Meanwhile at constant temperature of 60°C shows no correlation at all but at constant temperature of 40°C and 50°C shows negative and positive correlation respectively. This result shows inconsistency of β -sitosterol concentration in extracts correlate with the activity of α -glucosidase. Thus, synergy of all the compounds in the extract may responsible to the activity instead of single compound.

3. 4. α -amylase activity Inhibitory activity of α -amylase from *S. mahagoni* seeds extract at different condition shown in Table 8. In this study, the lowest percent inhibition was 2.12 \pm 1.24 ($p < 0.01$) at 25 MPa and 50°C and the highest was 34.89 \pm 1.23 ($p < 0.05$) at 30 MPa and 40°C. At high pressure and low temperature, the density of solvent increase [13, 34]. This will also enhanced the solvency power and increase the solute solubility [34] resulting in higher recovery of compound responsible to the activity of α -amylase.

Previous research on α -amylase inhibitory activity of *S. mahagoni* is shown in Table 9 with comparison with the result in this study. It shows that moderate percent inhibition was obtained compared with Subhadip *et al.* [25]. However, moderate α -amylase inhibition with strong α -glucosidase inhibition may offer better therapeutic strategy that could slow the availability of dietary carbohydrate substrate for glucose production in the gut [44]. Furthermore, the effect of pressure and temperature of SC-CO₂ also affect the α -amylase inhibitory activity.

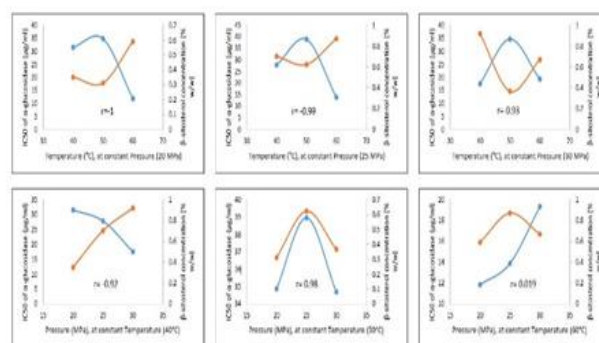

Figure 7. Correlation of IC₅₀ of α -glucosidase (μ g/ml) and β -sitosterol concentration (% w/w)

Figure 8 shows the effect of pressure and temperature on percent inhibition of α -amylase inhibitory activity. At constant pressure of 20 MPa, the temperature increases as the α -amylase inhibitory activity increases meanwhile at 25 and 30 MPa, the α -amylase inhibitory activity increases as temperature increase from 40 to 50°C and decrease as its reached 60°C. This is because as temperature further increase, the recovery of compound responsible to the inhibitory activity of α -amylase may decrease due to vaporization or decomposition of the volatile compound during the extraction.

Next, at constant temperature of 40°C shows the increase of the inhibition activity as pressure increase from 20 to 30 MPa. Meanwhile, at constant temperature of 50 and 60°C, the α -amylase inhibitory activity decrease as pressure decrease from 20 to 25 MPa but increase slight at pressure 30 MPa. The correlation of β -sitosterol content and α -amylase inhibitory activity was studied and shown in Figure 9.

The β -sitosterol concentration in extracts showed a positive correlation toward the activity of α -amylase at constant pressure of 20, 25 and 30 MPa. Meanwhile at constant temperature of 40°C shows positive correlation but at constant temperature of 50°C and 60°C shows negative correlation. This result shows inconsistency of β -sitosterol concentration in extracts correlate with the activity of α -amylase. Previous research showed that β -sitosterol may not affect α -amylase inhibitory activity [45].

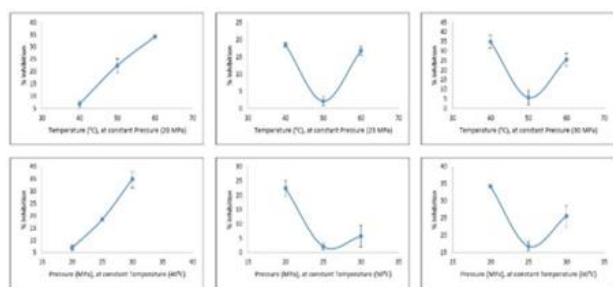

Figure 8. The effect of pressure and temperature on α -amylase inhibitory activity

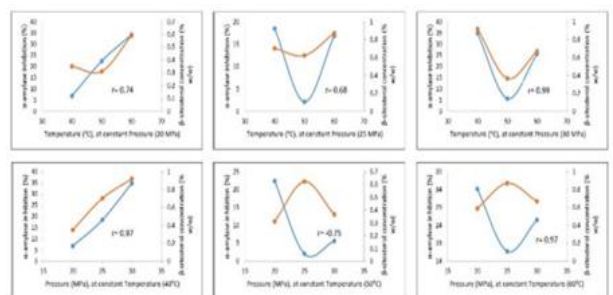

Figure 9. The effect of pressure and temperature on α -amylase inhibitory activity

TABLE 8. α -Amylase inhibitory activity of *S. mahagoni* seeds extract at different conditions (pressure, P and temperature, T). The values presented are expressed as mean \pm standard error of the mean of triplicate experiments.

Condition (s)	Inhibition (%)
Positive control	94.34 \pm 0.62
P= 20MPa, T= 40°C	6.86 \pm 1.30*
P= 20MPa, T= 50°C	22.44 \pm 2.82*
P= 20MPa, T= 60°C	34.21 \pm 0.48*
P= 25MPa, T= 40°C	18.50 \pm 0.67*
P= 25MPa, T= 50°C	2.12 \pm 1.24*
P= 25MPa, T= 60°C	16.82 \pm 1.23*
P= 30MPa, T= 40°C	34.89 \pm 1.23*
P= 30MPa, T= 50°C	5.69 \pm 3.88*
P= 30MPa, T= 60°C	25.58 \pm 3.11*

TABLE 9. Comparison of extraction method on % inhibitory activity of α -amylase inhibitory from *S. mahagoni* seeds extract at concentration of 100 μ g/ml.

<i>Swietenia mahagoni</i> seeds extraction method	% Inhibition	Reference
Petroleum ether maceration	64.84 \pm 0.52	[25]
SC-CO ₂	34.89 \pm 1.23	This study

4. CONCLUSION

Swietenia mahagoni seeds extract exhibit a strong α -glucosidase activity with mild α -amylase activity. In addition, the relationship of β -sitosterol content in extract and the inhibitory activities of α -glucosidase and α -amylase shows that β -sitosterol do not contribute to the activities but may be the synergize of all compounds in the extract.

5. ACKNOWLEDGEMENT

The authors would like to acknowledge the financial support from the Ministry of Higher Education Malaysia and Universiti Teknologi Malaysia under Fundamental Research Grant Scheme (R.J130000.7846.4F929), GUP grant (Q.J130000.2546.16H29), and Higher Institution Centre of Excellence (HiCOE) grant (R.J090301.7846.4J180). The authors would also like to acknowledge the technical and management support from Research Management Centre (RMC), Universiti Teknologi Malaysia.

6. REFERENCE

- Adefegha, S.A., Oboh, G., Adefegha, O.M., Boligon, A.A. and Athayde, M.L., "Antihyperglycemic, hypolipidemic, hepatoprotective and antioxidative effects of dietary clove (*Syzygium aromaticum*) bud powder in a high-fat diet/streptozotocin-induced diabetes rat model", *Journal of the Science of Food and Agriculture*, Vol. 94, No. 13, (2014), 2726-2737.
- Kumar, S., Narwal, S., Kumar, V. and Prakash, O., "A-glucosidase inhibitors from plants: A natural approach to treat diabetes", *Pharmacognosy Reviews*, Vol. 5, No. 9, (2011), 19.
- Association, A.D., "Diagnosis and classification of diabetes mellitus", *Diabetes Care*, Vol. 37, No. Supplement 1, (2014), S81-S90.
- Cheng, A.Y. and Fantus, I.G., "Oral antihyperglycemic therapy for type 2 diabetes mellitus", *Canadian Medical Association Journal*, Vol. 172, No. 2, (2005), 213-226.
- Casirola, D.M. and Ferraris, R.P., "A-glucosidase inhibitors prevent diet-induced increases in intestinal sugar transport in diabetic mice", *Metabolism*, Vol. 55, No. 6, (2006), 832-841.
- WRESDIYATI, T., SA'DIAH, S., Winarto, A. and Febriyani, V., "Alpha-glucosidase inhibition and hypoglycemic activities of swietenia mahagoni seed extract", *HAYATI Journal of Biosciences*, Vol. 22, No. 2, (2015), 73-78.
- Tas, S., Sarandol, E., Ziyank, S., Aslan, K. and Dirican, M., "Effects of green tea on serum paraoxonase/arylesterase activities in streptozotocin-induced diabetic rats", *Nutrition research*, Vol. 25, No. 12, (2005), 1061-1074.
- Triggle, C.R. and Ding, H., "Cardiovascular impact of drugs used in the treatment of diabetes", *Therapeutic advances in chronic disease*, Vol. 5, No. 6, (2014), 245-268.
- Goh, B.H., Abdul Kadir, H., Abdul Malek, S. and Ng, S.W., "Swietenolide diacetate from the seeds of swietenia macrophylla", *Acta Crystallographica Section E: Structure Reports Online*, Vol. 66, No. 6, (2010), o1396-o1396.
- Goh, B.H. and Kadir, H.A., "In vitro cytotoxic potential of swietenia macrophylla king seeds against human carcinoma cell lines", *Journal of Medicinal Plants Research*, Vol. 5, No. 8, (2011), 1395-1404.
- Maiti, A., Dewanjee, S., Kundu, M. and Mandal, S.C., "Evaluation of antidiabetic activity of the seeds of swietenia macrophylla in diabetic rats", *Pharmaceutical Biology*, Vol. 47, No. 2, (2009), 132-136.
- Balijepalli, M.K., Suppaiah, V., Chin, A.-m., Buru, A.S., Sagineedu, S.R. and Pichika, M.R., "Acute oral toxicity studies of swietenia macrophylla seeds in sprague dawley rats", *Pharmacognosy Research*, Vol. 7, No. 1, (2015), 38.
- Liza, M., Rahman, R.A., Mandana, B., Jinap, S., Rahmat, A., Zaidul, I. and Hamid, A., "Supercritical carbon dioxide extraction of bioactive flavonoid from strobilanthes crispus (pecah kaca)", *Food and Bioproducts Processing*, Vol. 88, No. 2-3, (2010), 319-326.
- Liza, M.S., Russly, A.R., Jinap, S., Azizah, H. and Md, Z., "Optimization of extraction condition for supercritical carbon dioxide (scco 2) extraction of strobilantes crispus (pecah kaca) leaves by response surface methodology", *Journal of Food Processing and Technology*, Vol. 4, No. 1, (2013).
- Foster, N., Mammucari, R., Dehghani, F., Barrett, A., Bezanehtak, K., Coen, E., Combes, G., Meure, L., Ng, A. and Regtop, H.L., "Processing pharmaceutical compounds using dense gas technology", *Industrial & Engineering Chemistry Research*, Vol. 42, No. 25, (2003), 6476-6493.
- Schuler, I., Milon, A., Nakatani, Y., Ourisson, G., Albrecht, A.-M., Benveniste, P. and Hartman, M.-A., "Differential effects of plant sterols on water permeability and on acyl chain ordering of soybean phosphatidylcholine bilayers", *Proceedings of the National Academy of Sciences*, Vol. 88, No. 16, (1991), 6926-6930.
- Saeidnia, S., Manayi, A., Gohari, A.R. and Abdollahi, M., "The story of beta-sitosterol-a review", *European Journal of Medicinal Plants*, Vol. 4, No. 5, (2014), 590.
- Loizou, S., Lekakis, I., Chrousos, G.P. and Moutsatsou, P., "B-sitosterol exhibits anti-inflammatory activity in human aortic endothelial cells", *Molecular Nutrition & Food Research*, Vol. 54, No. 4, (2010), 551-558.
- Ju, Y.H., Clausen, L.M., Allred, K.F., Almada, A.L. and Helferich, W.G., "B-sitosterol, β -sitosterol glucoside, and a mixture of β -sitosterol and β -sitosterol glucoside modulate the growth of estrogen-responsive breast cancer cells in vitro and in ovariectomized athymic mice", *The Journal of Nutrition*, Vol. 134, No. 5, (2004), 1145-1151.
- Miettinen, T.A. and Gylling, H., "Ineffective decrease of serum cholesterol by simvastatin in a subgroup of hypercholesterolemic coronary patients", *Atherosclerosis*, Vol. 164, No. 1, (2002), 147-152.
- Vivancos, M. and Moreno, J.J., "B-sitosterol modulates antioxidant enzyme response in raw 264.7 macrophages", *Free Radical Biology and Medicine*, Vol. 39, No. 1, (2005), 91-97.
- Gupta, R., Sharma, A.K., Dobhal, M., Sharma, M. and Gupta, R., "Antidiabetic and antioxidant potential of β -sitosterol in streptozotocin-induced experimental hyperglycemia", *Journal of Diabetes*, Vol. 3, No. 1, (2011), 29-37.
- Maiti, A., Dewanjee, S. and Sahu, R., "Isolation of hypoglycemic phytoconstituent from swietenia macrophylla seeds", *Phytotherapy Research*, Vol. 23, No. 12, (2009), 1731-1733.
- Hashim, M.A., Yam, M.F., Hor, S.Y., Lim, C.P.P., Asmawi, M.Z. and Sadikun, A., "Anti-hyperglycaemic activity of swietenia macrophylla king (meliaceae) seed extracts in normoglycaemic rats undergoing glucose tolerance tests", *Chinese Medicine*, Vol. 8, No. 1, (2013), 11.
- Hajra, S., Mehta, A., Pandey, P., John, J., Mehta, P. and Vyas, S., "Free radical scavenging and α -amylase inhibitory activity of swietenia mahagoni seeds oil", *International Journal of Pharmacognosy and Phytochemical Research*, Vol. 5, No. 1, (2013), 51-56.
- Karan, S.K., Mishra, S.K., Pal, D. and Mondal, A., "Isolation of sitosterol and evaluation of antidiabetic activity of aristolochia indica in alloxan-induced diabetic mice with a reference to in-vitro antioxidant activity", *Journal of Medicinal Plants Research*, Vol. 6, No. 7, (2012), 1219-1223.
- Sánchez-Machado, D., López-Hernández, J., Paseiro-Losada, P. and López-Cervantes, J., "An hplc method for the quantification of sterols in edible seaweeds", *Biomedical Chromatography*, Vol. 18, No. 3, (2004), 183-190.
- Jemain, M.M., Musa'adah, M.N., Rohaya, A., Rashid, L.A. and Hadiani, I.N., "In vitro antihyperglycaemic effects of some Malaysian plants", *Journal of Tropical Forest Science*, Vol. 23, No. 4, (2011), 467-472.
- Bothon, F.T., Debiton, E., Avlessi, F., Forestier, C., Teulade, J.-C. and Sohounhloue, D.K., "In vitro biological effects of two anti-diabetic medicinal plants used in Benin as folk medicine", *BMC Complementary and Alternative Medicine*, Vol. 13, No. 1, (2013), 51-58.
- Rivera-Chávez, J., González-Andrade, M., Del Carmen González, M., Glenn, A. E., and Mata, R., "A-glucosidase inhibitors from mexu 27095, an endophytic fungus from *hintonia latiflora*", *Phytochemistry*, Vol. 94, (2013), 198-205.

31. Miller, G.L., "Use of dinitrosalicylic acid reagent for determination of reducing sugar", *Analytical Chemistry*, Vol. 31, No. 3, (1959), 426-428.
32. Ali, H., Houghton, P. and Soumyanath, A., "A-amylase inhibitory activity of some malaysian plants used to treat diabetes; with particular reference to phyllanthus amarus", *Journal of Ethnopharmacology*, Vol. 107, No. 3, (2006), 449-455.
33. Machmudah, S., Kawahito, Y., Sasaki, M. and Goto, M., "Supercritical co2 extraction of rosehip seed oil: Fatty acids composition and process optimization", *The Journal of supercritical fluids*, Vol. 41, No. 3, (2007), 421-428.
34. Pereira, C.G. and Meireles, M.A.A., "Supercritical fluid extraction of bioactive compounds: Fundamentals, applications and economic perspectives", *Food and Bioprocess Technology*, Vol. 3, No. 3, (2010), 340-372.
35. Hartati Salleh, L., Yunus, A. and Aziz, A., "Optimization of supercritical co2 extraction of swietenia mahagoni seed by response surface methodology", *Journal of Teknologi and Sciences Engineering*, Vol. 67, No. 1, (2014), 15-20.
36. Sajftrtová, M., Ličková, I., Wimmerová, M., Sovová, H. and Wimmer, Z., "B-sitosterol: Supercritical carbon dioxide extraction from sea buckthorn (*hippophae rhamnoides* l.) seeds", *International Journal of Molecular Sciences*, Vol. 11, No. 4, (2010), 1842-1850.
37. Vilegas, J.H., de Marchi, E. and Lancas, F.M., "Extraction of low-polarity compounds (with emphasis on coumarin and kaurenoic acid) from *mikania glomerata* ('guaco') leaves", *Phytochemical Analysis: An International Journal of Plant Chemical and Biochemical Techniques*, Vol. 8, No. 5, (1997), 266-270.
38. Kawahito, Y., Kondo, M., Machmudah, S., Sibano, K., Sasaki, M. and Goto, M., "Supercritical co2 extraction of biological active compounds from loquat seed", *Separation and Purification Technology*, Vol. 61, No. 2, (2008), 130-135.
39. Catchpole, O., Perry, N., Da Silva, B., Grey, J. and Smallfield, B., "Supercritical extraction of herbs i: Saw palmetto, st john's wort, kava root, and echinacea", *The Journal of Supercritical Fluids*, Vol. 22, No. 2, (2002), 129-138.
40. Simandi, B., Kristo, S.T., Kery, A., Selmeczi, L., Kmecz, I. and Kemeny, S., "Supercritical fluid extraction of dandelion leaves", *The Journal of Supercritical Fluids*, Vol. 23, No. 2, (2002), 135-142.
41. András, C.D., Simándi, B., Örsi, F., Lambrou, C., Missopolinou-Tatala, D., Panayiotou, C., Domokos, J. and Doleschall, F., "Supercritical carbon dioxide extraction of okra (*hibiscus esculentus* l) seeds", *Journal of the Science of Food and Agriculture*, Vol. 85, No. 8, (2005), 1415-1419.
42. Cossuta, D., Simándi, B., Vági, E., Hohmann, J., Prechl, A., Lemberkovics, É., Kéry, Á. and Keve, T., "Supercritical fluid extraction of vitex agnus castus fruit", *The Journal of Supercritical Fluids*, Vol. 47, No. 2, (2008), 188-194.
43. Díaz-Reinoso, B., Moure, A., Domínguez, H. and Parajó, J.C., "Supercritical co2 extraction and purification of compounds with antioxidant activity", *Journal of Agricultural and Food Chemistry*, Vol. 54, No. 7, (2006), 2441-2469.
44. Kajaria, D., Ranjana, J.T., Tripathi, Y.B. and Tiwari, S., "In-vitro α amylase and glycosidase inhibitory effect of ethanolic extract of antiasthmatic drug—shirishadi", *Journal of Advanced Pharmaceutical Technology & Research*, Vol. 4, No. 4, (2013), 206.
45. Safamansouri, H., Nikan, M., Amin, G., Sarkhail, P., Gohari, A.R., Kurepaz-Mahmoodabadi, M. and Saeidnia, S., "A-amylase inhibitory activity of some traditionally used medicinal species of labiatae", *Journal of Diabetes & Metabolic Disorders*, Vol. 13, No. 1, (2014), 114.

Inhibitory Effects of *Swietenia Mahagoni* Seeds Extract on A-Glucosidase and A-Amylase

N. S. Md Norodin^{a,b}, L. Md Salleh^{a,b}, N. Yusof^c, N. M. Mustapha^d, F. Kamarulzaman^d, M. A. Mohamed Zahari^{a,b}, N. A. Bakeri^{a,b}

^a Center of Lipids Engineering and Applied Research (CLEAR), Ibnu Sina Institute Scientific & Industrial Research (Ibnu Sina ISIR), Universiti Teknologi Malaysia, Johor, Malaysia

^b Department of Bioprocess and Polymer Engineering, School of Chemical and Energy Engineering, Universiti Teknologi Malaysia, Johor, Malaysia

^c Advanced Membrane Technology Research Centre (AMTEC), Universiti Teknologi Malaysia, Skudai, Johor, Malaysia

^d Natural Product Division, Forest Research Institute Malaysia (FRIM), Selangor Darul Ehsan, Malaysia

P A P E R I N F O

چکیده

Paper history:

Received 16 December 2017

Received in revised form 25 January 2018

Accepted 08 February 2018

Keywords:

Swietenia Mahagoni Seed,
A-Glucosidase Enzyme,
A-Amylase Enzyme,
Supercritical Carbon Dioxide (SC-CO₂)
Extraction

مطالعه حاضر به بررسی فعالیت مهارکننده استخراج عصاره گیاه ماهون در آزمایش مهار آنزیم α گلوکز و α آمیلاز میپردازد. عصاره گیاه ماهون با استفاده از دی اکسید کربن فوق بحرانی با فشار 20-30 مگاپاسکال و دماهای 40-60 درجه سانتیگراد استخراج میشوند. بازدهی روغن حاصل از آنالیز با آنزیم α گلوکز و α آمیلاز آنالیز می شود. تمامی داده ها در قالب میانگین \pm انحراف معیار برای آزمایشهای سه گانه تفسیر شده اند. از نرم افزار *Statistica* نسخه 7 برای معنی دار شدن آماری آنالیز یکطرفه استفاده شد و غظت عصاره 50 درصد آنزیم مهارکننده با استفاده از نرم افزار *GraphPad Prism* 6.0 تعیین شد. قدرت مهارکنندگی عصاره گیاه ماهون در فعالیت آنزیم α گلوکز ($98.4\% \pm 0.2$) شدید و در فعالیت آنزیم α آمیلاز متوسط ($34.9\% \pm 1.2$) است. این یافته ها نشان میدهد که عصاره گیاه ماهون میتواند ماده ضد دیابت طبیعی موثر باشد.

doi: 10.5829/ije.2018.31.08b.20