

Requirements engineering of Malaysian radiological medical emergency response simulator

Amy Hamijah binti Ab. Hamid, Mohd Zaidi Abd Rozan, Roliana Ibrahim, Safaai Deris, Ali Selamat & Muhd. Noor Muhd. Yunus

To cite this article: Amy Hamijah binti Ab. Hamid, Mohd Zaidi Abd Rozan, Roliana Ibrahim, Safaai Deris, Ali Selamat & Muhd. Noor Muhd. Yunus (2018) Requirements engineering of Malaysian radiological medical emergency response simulator, Journal of Information and Telecommunication, 2:3, 305-321, DOI: [10.1080/24751839.2017.1376559](https://doi.org/10.1080/24751839.2017.1376559)

To link to this article: <https://doi.org/10.1080/24751839.2017.1376559>



© 2018 The Author(s). Published by Informa UK Limited, trading as Taylor & Francis Group



Published online: 27 Mar 2018.



Submit your article to this journal [↗](#)



Article views: 200



View related articles [↗](#)



View Crossmark data [↗](#)

Requirements engineering of Malaysian radiological medical emergency response simulator

Amy Hamijah binti Ab. Hamid^{a,b}, Mohd Zaidi Abd Rozan^a, Roliana Ibrahim^a, Saffaai Deris^d, Ali Selamat^{b,c,e} and Muhd. Noor Muhd. Yunus^b

^aDepartment of Information Systems Faculty of Computing, Universiti Teknologi Malaysia (UTM), Johor Bahru, Malaysia; ^bMalaysian Nuclear Agency (Nuklear Malaysia), Ministry of Science, Technology and Innovation (MOSTI), Kajang, Malaysia; ^cDepartment of Software Engineering, Faculty of Computing, Universiti Teknologi Malaysia (UTM), Johor Bahru, Malaysia; ^dFaculty of Bioengineering and Technology, Universiti Malaysia Kelantan (UMK), Kota Bharu, Malaysia; ^eCenter for Basic and Applied Research, University of Hradec Kralove, FIM, Hradec Kralove, Czech Republic

ABSTRACT

The development of the Malaysian radiological medical emergency response simulator emphasized human factors according to the stakeholder's tacit and explicit knowledge. These human factors criteria were usability tested and analysed according to the socio-technical components. These analyses and interpretations were corroborated by the statistical criteria which emphasized on business process-based requirements modelling and simulation system development tools. Recent findings suggested that there were no differences of risk perceptions among these multi-agency stakeholders in the respective emergency planning framework and simulator. However, the stakeholders had differences in knowledge and experiences in the radiological and nuclear emergency planning framework (RANEPF). This paper analyses the proposed conceptual framework for further enhancement of the current RANEPF simulator. This development was in concurrence with the proposed hypothesis of the process factors and response diagram. The majority (75%) of the stakeholders and experts, who had been interviewed, witnessed and accepted that the simulator would be effective to resolve various types of disaster and resource management issues. We suggest further investigation to establish the additional functionality of the simulator as a strategist, condensed, concise, comprehensive public disaster preparedness and intervention guidelines to be a useful and efficient computer simulation.

ARTICLE HISTORY



Received 11 March 2017
Accepted 4 September 2017

KEYWORDS

Emergency; requirement; interpretive case study; planning framework; modelling; simulation

Introduction

Asia is home to 128 operable nuclear power reactors, 40 under construction and firm plans for 90 more. There are eight nuclear power plants (NNPs) and research reactors in South

CONTACT Amy Hamijah binti Ab. Hamid  amyhamijah@gmail.com  aselamat@utm.my

© 2018 The Author(s). Published by Informa UK Limited, trading as Taylor & Francis Group
This is an Open Access article distributed under the terms of the Creative Commons Attribution License (<http://creativecommons.org/licenses/by/4.0/>), which permits unrestricted use, distribution, and reproduction in any medium, provided the original work is properly cited.

East Asia (ASEAN). Six research nuclear reactors were active and operational in Malaysia, Indonesia, Thailand and Vietnam. Furthermore, Vietnam has plans to build two NPPs in the near future. Previous Malaysian experience with the climatic haze problem originated from the malicious act of Indonesian forest burning. Despite that, triumphant regional collaboration was established to overcome this crisis immediately from worsening. Thus, the same scenario could happen in the same fashion if any radiological and nuclear (RN) disasters or emergencies ever occurred in ASEAN or Asia Pacific region. To be prepared, ASEAN needs a regional and incorporated international RN emergency plan such as radiation and nuclear emergency planning framework (RANEPF).

Accordingly, the disastrous meltdown of radiation and nuclear events require a cumbersome and complicated scale of emergency health and social care capacity planning framework. Therefore, this paper recommended guideline that will prevent unnecessary conflicts such as insufficient, inconsistent and impractical requirements of the simulation system analysis and design (Hamid et al., 2015a, 2015b). Foremost, data collection of the research questionnaires is constructed theoretically refers to the identified customers, participants, processes and activities in the associated emergency plan as the simulation system components respectively. Consequently, these simulation system components are developed and validated as the RANEPF simulator that implied business process-based requirements modelling and simulation system development (BPRMS) and integrated with the radiological trauma triage capacity planning framework. Suggested development and validation are solutions that will improve the Malaysian RN emergency planning framework as the proposed simulator. This simulator plans and organizes the stakeholder's capacity and capability for radiological medical response and risk assessment. Significantly, these solutions are considered helpful to validate assurance of the public acceptance to the emergency regulatory framework prominent to the Malaysian Nuclear Power Development Program (Jabatan Perdana Menteri, 2010).

Case studies and research methods

This research implemented empirical and non-empirical studies which consisted of case studies data gathered among 96 stakeholders and experts using mostly open- and close-ended questionnaires but also, interviews. In addition, this research included 357 random samples of patients from operational, managerial and clinical information database. This research also relied on the simulator analysis and design according to the information systems (IS) theoretical interpretation and methodological triangulation by implementing BPRMS. The theoretical interpretation was refers to the proposed socio-technical components indicated in the following sections. Prior to earlier research findings, the research variables were independent and unbiased by having inherent relationships (Hamid, Rozan, Deris, & Ibrahim, 2013; Hamid et al., 2015, *Prototyping and validating*; Hamid, Rozan, Ibrahim, Deris, & Yunus, 2014). Therefore, this research indicated consequential and situated actions in the emergency planning framework were mutually constitutive (Feldman & Orlikowski, 2011). The research focused on the theory building (generation) technique that is divided into (1) requirements feasibility validation and synthesis; (2) designing of the simulator interfaces according to the conceptual framework; (3) process flow and capacity measurement analysis and (4) finalized justification of the simulator usability test analysis as the following sections.

Requirements feasibility validation and synthesis

The research participants' perceptions and experts' justifications are validated and synthesized according to the overall process map in Figure 1 (Aguilar-Saven, 2004; Hamid et al., 2013). The research validation and synthetization discussed in this section as the following: (1) thematic synthesis conceptualization, (2) affinity analysis, (3) Pareto analysis and (4) cause and effect analysis.

Conceptualization of the synthesis

Prior 'as-is' process models and RANEPF snapshot highlighted four themes described as the research key processes and activities (see Table 1). These themes would be interpreted, transcribed and mapped according to the information systems design theory (ISDT) key concepts in order to determine the integral chain of evidence between them.

Table 1 notifies the respondents' identifications, namely, C1–C20 as the represented cases of the research participation distribution. This table validated the possible relationships among the process elements as to be developed into simulation system components (Avison & Fitzgerald, 2006; Hamid et al., 2013; Urquhart, 2013).

Affinity analysis

Secondly, the affinity analysis indicated the proposed contingency (or contingent ranking) table as depicted in Table 2. The affinity analysis calculation is defined as in (Asgary &

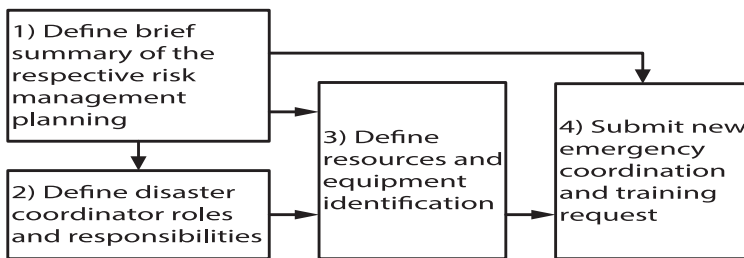

Figure 1. Overall process map.

Table 1. Mapping the features of highlighted themes and ISDT key concepts.

| Theme | ISDT key concepts | | | | | |
|--|-------------------|------------------|------------------|--------------|-----------------------|-----------------------|
| | | | | System | | |
| | Data | Information | Knowledge | People | Objects | Procedures |
| Process 1: Define brief summary of RN risk management planning | | C2 | C2 | C16 | C2 | C2, C16 |
| Process 2: Define disaster coordinator roles and responsibilities | C14 | C5, C8, C14, C20 | C5, C8, C14, C20 | C16, C20 | | C5, C8, C16, C18, C20 |
| Process 3: Define resources and equipment identification | C15 | C2, C8, C10 | C2, C8, C10 | C8, C10, C18 | C2, C8, C10, C17, C18 | C2, C8, C10, C18 |
| Process 4: Submit new emergency plan coordination and training request | C17 | C5, C6, C17, C20 | C5, C6, C17, C20 | C20 | | C5, C6, C20 |

Table 2. Contingent ranking of the affinity analysis.

| Theme | ISDT key concepts | | | | | | RF | TP (%) |
|----------------------|-------------------|----|----|--------|---|----|----|--------|
| | D | I | K | System | | | | |
| | | | | A | B | C | | |
| Process 1 | 0 | 1 | 1 | 2 | 1 | 2 | 7 | 11 |
| Process 2 | 1 | 7 | 5 | 2 | 0 | 5 | 20 | 31 |
| Process 3 | 1 | 5 | 3 | 3 | 5 | 5 | 22 | 34 |
| Process 4 | 1 | 5 | 5 | 1 | 0 | 3 | 15 | 23 |
| Total no. of answers | 3 | 18 | 14 | 8 | 6 | 15 | 64 | 100 |

Abbreviations: D, data; I, information; K, knowledge; A, people; B, objects; C, procedures; RF, relative frequency; TP, total percentage.

Mousavi-Jahromi, 2011; Subbiah & Ibrahim, 2011). The suggested equation is to indicate whether the data are being impartial or else. Reported margin of error is typically about twice the standard deviation which is the radius of 95% confidence interval (CI). The outcome of the cited formulation is placed in Table 2. This analysis is a method to experiment varying degrees of relationship among the processes and activities performed in the respective phenomenon. The analysis is also a data mining technique to discover co-occurrence relationships among the research participants. The technique was applied to determine the prominent information to be integrated within the simulation system components. The information generated divergent thinking related to activities performed by (or recorded about) individuals or organizations simultaneously in the respective emergency planning frameworks. This process is essential to avoid duplication. Data generation activity provided individual terms of information; edited research participants' perceptions were later sorted, grouped and transcribed as categories determined by the ISDT key concepts (that referred to thematic coding procedure) (Avison & Fitzgerald, 2006).

Contingency analysis or ranking, a survey-based method and a choice-based modelling focused on preferences modelling of the emergency planning key processes and activities described according to their attributes and levels (Asgary & Mousavi-Jahromi, 2011) (Hoang, 2017). Attribute valuation of the contingent ranking allows more than one direct route of valuation. This implication involved characteristics or attributes of such processes and marginal changes in their characteristics. The ranking logit is ordered as model specification and the maximum likelihood as the estimation procedure.

This analysis determines the relationship dependency between the classifications of IS development key concepts and the research participants' opinions using cut-off or independent test as described in Table 3. The analysis applied cross tabulation to record and examines the relationships between two or more categorical variables. As a result, the *T* value was less (13.30) than the cut-off value (25), anticipated respondents' opinions are unbiased towards the ISDT key concepts (see Table 4). Hence, these findings can be structured accordingly featuring the transformation of the key concepts into simulation components later.

Pareto analysis

Table 5 is the Pareto analysis displayed the most common sources might take issue and challenged circumstances in the framework process. The 80–20 rule is the evident in the Pareto chart: 80% of the emergency planning framework issues came from

Table 3. The independent test of the affinity analysis.

- Step 1:** Create categorization of the frequency table accordingly
- Step 2:** $n_i, n_j/n$
- Step 3:** $n_{ij}-(n_i, n_j/n)$
- Step 4:** $[n_{ij}-(n_i, n_j/n)]^2$
- Step 5:** $[n_{ij}-(n_i, n_j/n)]^2 / (n_i, n_j/n)$

Table 4. Finalized result of the independent test.

| | | | | | | Total |
|---------------|------|------|------|------|------|-------|
| 0.33 | 0.48 | 0.18 | 1.45 | 0.18 | 0.08 | 2.69 |
| 0.00 | 0.34 | 0.09 | 0.10 | 1.88 | 0.02 | 2.43 |
| 0.00 | 0.23 | 0.68 | 0.02 | 4.18 | 0.00 | 5.12 |
| 0.13 | 0.14 | 0.90 | 0.41 | 1.41 | 0.08 | 3.06 |
| SUM (T) | | | | | | 13.30 |
| CUT-OFF VALUE | | | | | | 25.00 |

Table 5. Pareto analysis of the overall process map themes.

| Theme | Frequency | Cumulative frequency | Cumulative percentage |
|----------------------|-----------|----------------------|-----------------------|
| Process 3 | 22 | 22 | 35 |
| Process 2 | 20 | 42 | 66 |
| Process 4 | 15 | 57 | 89 |
| Process 1 | 7 | 64 | 100 |
| Total no. of answers | 64 | | |

processes 2 and 3, and 20% came from the causes as depicted in Figure 2 (Subbiah & Ibrahim, 2011; Tague, 2004). As a result, arranging the reasons in decreasing order yields a cumulative function that is concave. Figure 2 depicts reducing issues and challenges in the event of a radiological or nuclear disaster and emergencies by 80%, whereas the Pareto bar accounted and accumulated two-thirds (66%) of insufficient definition and identification of the disaster coordinator roles, responsibilities, resources and equipment, which causes three times higher the customer disappointment. The

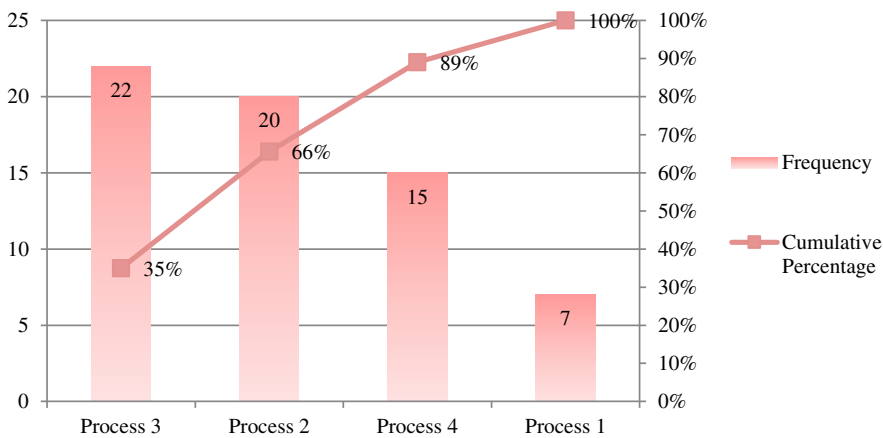

Figure 2. Pareto chart is corresponding to the same analysis mentioned above.

customers are the Malaysian licensed radiation workers and also radiation related workers recognized as the research stakeholders in the research. In addition to that, the surrounding community is also included. As a new research discovery, clinical patients are indicated as customers as well, prior to be rescued during any disaster and emergency situations (Hamid et al., 2013). Significantly, these findings were the highlighted structure of the nuclear safety consequences as defined in (Hamid et al., 2013).

Cause and effect analysis

Prior to the Pareto analysis, nearly two-thirds (66%) of the organizational issues consisted of the stakeholders' incapability and incompetence. Consequently, the Pareto analysis findings will be followed by the cause and effect analysis in order to highlight critical factors of the process models referred to as ISDT key concepts and job hazard analysis using a root cause analysis (Avison & Fitzgerald, 2006; Chan, 1998; Crutchfield & Roughton, 2008; Kaoru Ishikawa, 1990). This analysis applied the exploration of true 'root cause' and suggested adequate corrective actions. The main corrective actions were to define and identify the disaster coordinators' capacities and capabilities in terms of their roles, responsibilities, resources and equipment. The most prominent indicator of the simulator key requirements and success factors, according to the experts' justification was to practically implement the respective emergency framework mechanisms from initiating RN disasters and emergencies best practices and lesson learned, whereby they showed the direction, as well as, prioritized and useful goals to be achieved.

Designing the simulation interfaces according to the conceptual framework

The conceptual framework of the simulation system analysis and design, namely, [Figure 3](#) is the hypothesis process factors and responses diagram underlying the system requirements feasibility validation and synthesis. The causes are the controllable and uncontrollable input factors, responses and output measures. This diagram applied the impact analysis of the respective phenomenon. The main research contribution incorporated the know-how of the respective emergency planning framework into an agent-based social simulator development. Most significantly, this diagram contributed to the simulator design of experiments. It was constructed as a structured, organized method used to determine the relationship between the input factors (X1, X2) affecting a process and the output of the process (Y1, Y2) (Russell & Taylor, 2011).

[Figure 3](#) also depicts the enlisted translation and transformation of the emergency planning framework into a physically and empirically constructive agent-based social simulation system. Consequentially, [Figure 4](#) features multi-facet of the agent-based and discrete-event interfaces that implied agent-based and system dynamics modelling of the respective simulator.

The simulator purposefully aimed to prevent complete disorder in the pre-hospital care related to the incremental survival of the casualties accordingly. Cordially, this research provided health and social care plan for the respective RN emergency plans and response. The simulator applies patients' classification that refers to their injury and level of radiation

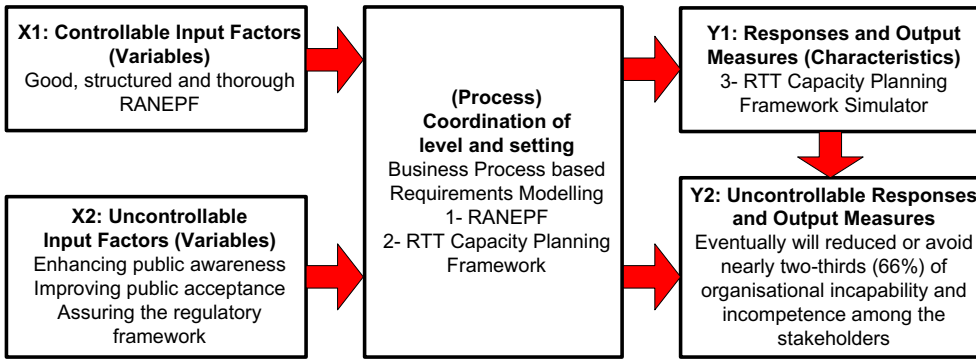

Figure 3. Process factors and responses diagram.

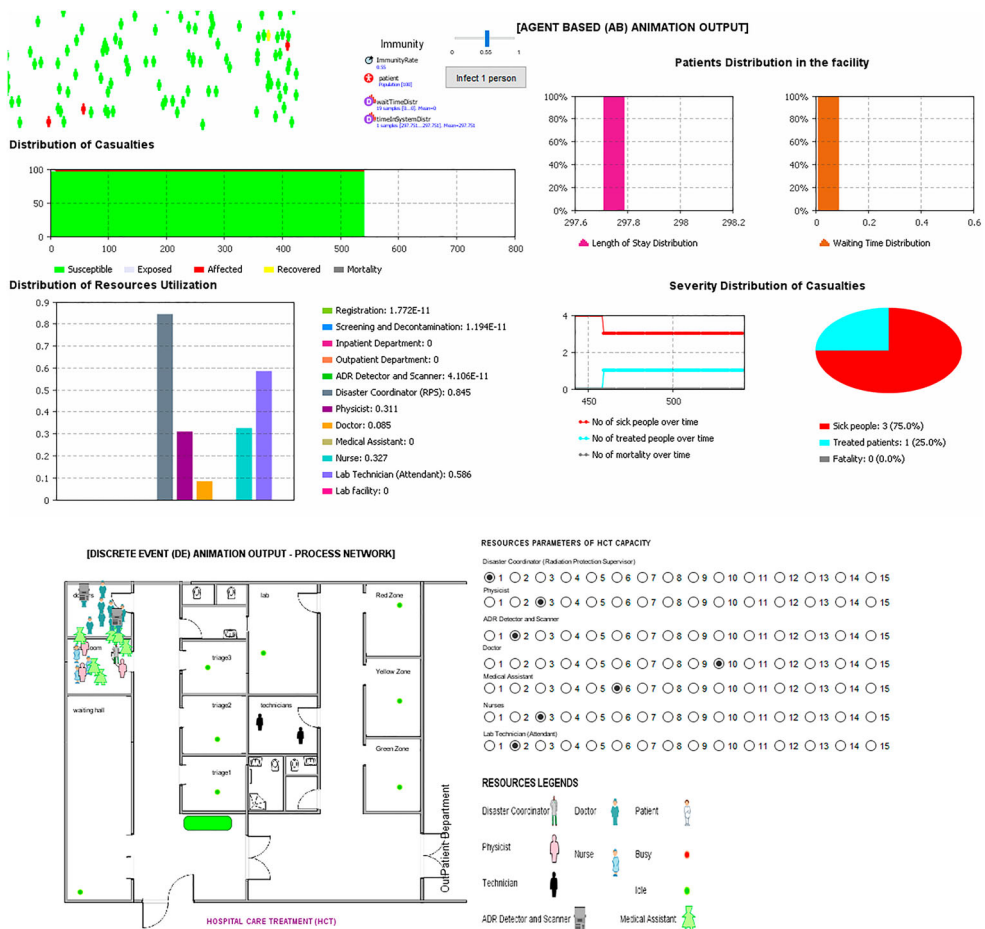

Figure 4. The simulator design.

sickness. The patients' diagnoses and treatment classification, estimated the supply and demand resources of the associated medical delivery system. This system also assisted the stakeholder's resources planning while managing the RN incidents of the

corresponding treatment areas promptly. First, the on-site emergency plan carried out decontamination activities at the site of the RN event, namely, initial area treatment. Second, the off-site emergency plan applied radiological trauma triage in the reception area or shelter and the hospital care treatment (HCT) areas. By simulating these conditions, the research framework of the integrated stakeholder's and system requirements was developed. These requirements were validated according to IS theoretical lenses by applying process simulation modelling.

The medical treatment and populations' decontamination are activated at the earliest minutes to hours of the RN disaster and emergency. Following that, the intermediate medical care is implemented from hours to days into the later phase of months and years respectively. This action indicated the execution of the respective radiological medical triage. This triage identified the patients' radiation exposure levels based on the characteristics of the acute radiation poisoning signs and symptoms. The poisoning verification refers to the patients' radiation sickness, which is believed to be radiological exposed only, contaminated only, both contaminated and exposed, and neither has been contaminated nor exposed. Consequently, the ongoing medical treatment of dedicated radiation injuries based on elaborated medical management can be defined as in (Waller et al., 2009). Additionally, radiation dosimetry is provided to evaluate the radiation dose exposure of the responders and public using physical measurements, predicted values and use of biological markers. Accordingly, this research proposed empowering people by increasing public awareness of emergencies and recommending personal preparedness plans (Kuljis, Paul, & Stergioulas, 2007).

Consequently, [Figure 4](#) depicts the justified components of the simulator design which divided into the animation input and output models, and related process coding interventions. The animation models of the simulator divided into agent-based and discrete-event interfaces; meanwhile the process coding interventions involved the susceptible-exposed-affected-recovered (SEAR) state charts (using agent-based and system dynamics modelling) and network-based process models. The simulation components refer to the problem statements of the Goiana situation (International Atomic Energy Agency, 1988, 1998a, 1998b) and related epidemic studies (Borshchev, 2013; Gunes, 2014).

According to the mentioned literatures above, in 1985, the cause of the Goiana radiological accident in Brazil originated from a radiography source with localized activity intake of 410-Sv dose range. This accident has been among the most serious radiological accidents ever. This accident happened when a private radiotherapy institute was moved to new premises and transported a cobalt-60 tele therapy unit and left a caesium-137 tele therapy unit without notifying the licensing authority (regulator). The unit was removed and dismantle improperly. The radioactive source is a form of highly soluble caesium chloride salt, which was readily dispersible. The environment was contaminated and several persons critically affected by the radiation.

Capacity measurement analysis of the process flow

[Figure 5](#) is the measured process flow of the simulator capacity performance. This flow chart displayed the radiological and medical trauma triage capacity planning framework that refers to SEARS categorization as in [Table 6](#) (Hamid, Wah, Majid, Samah, & Abdullah, 2012). The process flow unit consisted of a patient. [Table 6](#) is the patient categorization

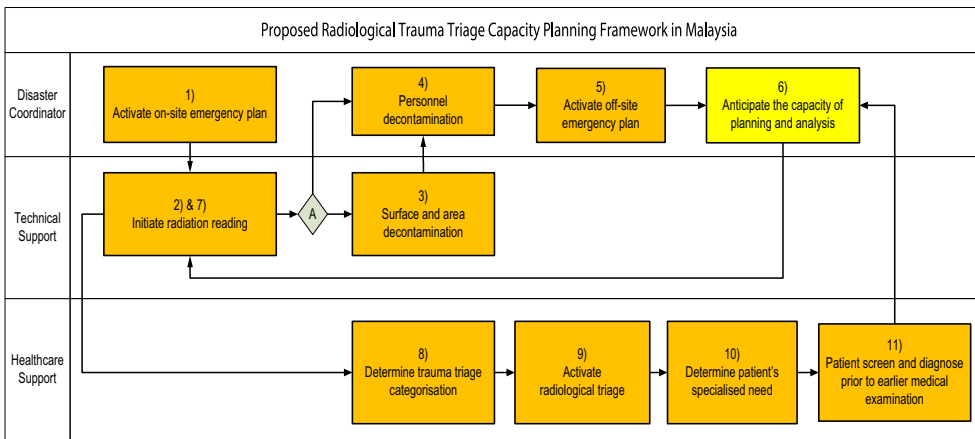

Figure 5. The simulator justified workflow diagram.

Table 6. The patient categorization according to absorbed dose range and radiation sickness.

| Type of patient | Absorbed dose range (Gray) | Triage categorization | SEAR distribution |
|-----------------|----------------------------|-----------------------|--------------------|
| P1 | 4–6 | Severe | Affected/recovered |
| P2 | 2–3 | Moderate | Affected/recovered |
| P3 | <0.75–2 | Mild | Susceptible |
| P4 | 6–10 | Very severe | Mortality |

characteristics of the absorbed dose range and radiation sickness as stated in (Hamid, Samah, et al., 2011; Hamid, Rozan, et al., 2011; Hamid et al., 2012; Pidd, 2009). The patients were referred to as the radiological-affected casualties. The process flow time analysis anticipated a random sample of 357 patients over a month-long period. The patients' time estimation of entry and exit data points were individually analysed, refer to the hospital information database and radiological medical safety reports (Hamid, Samah, et al., 2011; Hamid et al., 2012).

Elongated scenario estimates simplified generic medical responses from 10 into 25 data points incorporated of the radiological medical response interventions within 83 minutes and 40 seconds. Figure 5 depicts the applied process flow time in precise and separate examinations into constituent workflow activities. The orange boxes indicate the summarized business process of the frameworks. Meanwhile, the yellow box describes the capacity planning and analysis of the underlying capability of the resources involved.

Furthermore, Figure 6 displays extended process flowchart of the prioritized activities and their precedence relationships. It is an instant process entry point of a patient embarking into the health and injury inspection facility finished with the coloured exit points as defined in (Hamid et al., 2015, Requirements engineering of Malaysia's; Hamid et al., 2016). Figures 5 and 6 depict the requirements feasibility analysis as an appropriate mechanism for the radiological medical emergency preparedness and response plans (Hamid et al., 2015, Prototyping and validating; Hamid et al., 2016). Consequently, each process must be sequentially operationalized and analysed based on the patients' activity and flow time during their visits. In another instance, the second activation of the radiological

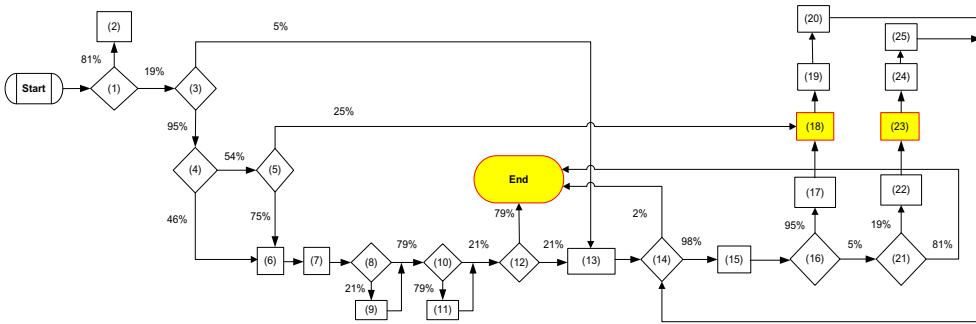

Figure 6. Process flowchart corresponding to the simulator.

triage activities for process 14–25 will be repeated once the patients’ accumulation reaches 98% with an average of 1.98 visits. Therefore, an average activity time for process 14 multiplied 1.98 for each medical visit before preceded into process 15 as in [Figure 6](#) according to the simulated data computations. Thus, the computations identified that path 5 of the first activation of the radiological triage is the most critically profound as it took 65 minutes delay of each patient treated in the estimated flow-time efficiency as defined in (1) (Anupindi, Chopra, Deshmukh, Mieghen, & Zemel, 2006; Hamid et al., 2015, *Prototyping and validating*; Hamid et al., 2016):

$$\text{Flow-time efficiency} = \text{Theoretical flow time} / \text{Average flow time.} \tag{1}$$

Besides, the computerized simulation estimated the waiting time like nine times greater during radiological disaster and emergency in this scenario. Even though, all resources were scheduled to operate from 8.00 a.m. to 5.00 p.m. each day, six days per week. However, during the disruptive occurrence, the HCT operates 24 hours, 7 days per week for the prior 72 hours. The proposed mechanism in [Figure 6](#) indicated that the throughput (R) of each patient treatment is 24 minutes on average, which is 9 minutes behind the time of the accustomed medical response interventions. The throughput of a process, R, was the average number of flow units processed over time. Subsequently, the disaster coordinator is the main resource bottleneck with 33 minutes delay of each patient’s treatment. This theoretical capacity bottleneck indicated that no patient survived at this point. The bottleneck evaluation refers to the capacity utilization analysis in order to measure the effectiveness of the resource performance to be utilized by the process as defined in (2) as cited in (Anupindi et al., 2006; Hamid et al., 2015, *Prototyping and validating*; Hamid et al., 2016):

$$\begin{aligned} \text{Capacity utilization of resource pool } p &= \\ \text{Throughput/theoretical capacity of resource pool } (p_{pp} &= R/R_p). \end{aligned} \tag{2}$$

Simulation usability test analysis

[Figures 1](#) and [5](#) exhibit the simulator ‘as-is’ and ‘to-be’ abstract models. Beforehand, these models are validated concurrently before the simulator demonstration, whereas another

Table 7. Positioning of the inter-coder reliability analysis of the abstract models.

| Abstract models | Descriptions |
|-----------------|---|
| 'As-is' | <ul style="list-style-type: none"> The Kappa agreement is 85.75 (95% CI = 0.777 to 0.938) The inter-coder agreement was significant (p-value $<.05$) and almost perfect |
| 'To-be' | <ul style="list-style-type: none"> The Kappa agreement is 78.18 (95% CI = 0.685 to 0.879) The inter-coder agreement was significant (p-value $<.05$) and substantially perfect |

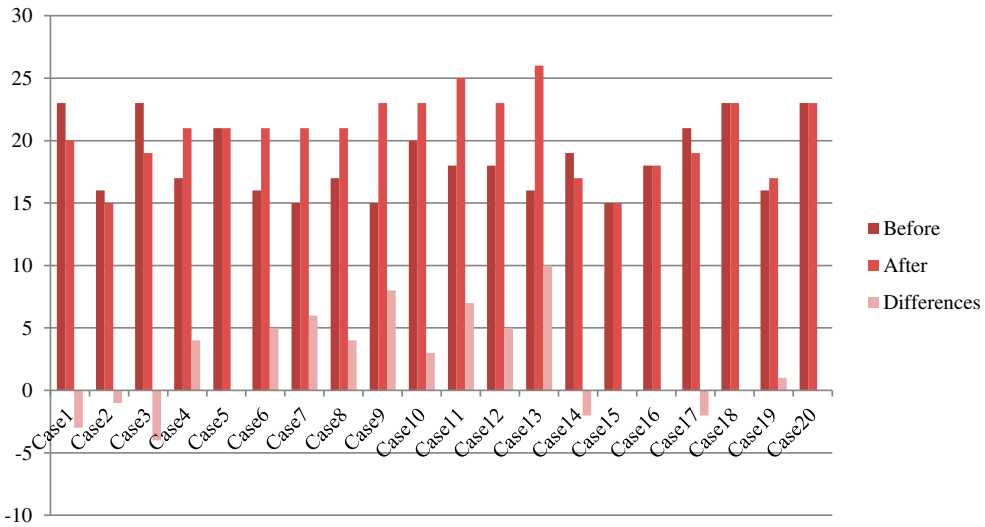

Figure 7. Agreement differences between the stakeholders in evaluating the simulator demonstrations.

demonstration is carried out to establish the usability test. Primarily, these validations are analysed to identify relative discrepancies of the simulator implementation (as depicted in Table 7 and Figure 7).

Table 7 explains the positioning analysis of the research variables of the given participants' perception are unbiased and independent (referred to the affinity analysis), but they have inherent relationships indicated through the socio-technical system components and ISDT key concepts justifications. Therefore, the perceptions given are in highly significant agreement with an average Kappa agreement of 82% indicated mutually constitutive process and simulation models by producing p -value less than .05 with 95% CI. Therefore, these processes and simulation models that referred to the work system framework components were highly agreed upon and accepted among the research participants. These components were important as an instruction to develop the simulation models. The highlighted justifications were brought to light by adapting theory building (generation) technique that emphasized on the hypothesized conceptual framework (see Figure 3).

Hence, Figure 7 presents in highly significant agreements among the research participants that displayed inherent relationships of the simulator elements respectively. On average, the majority (75%) of the stakeholders and experts who had been interviewed, witnessed and accepted that the simulator would be effective to resolve various types of disaster and resource management issues. This result indicates that there were no

exact differences of perspectives among the stakeholders before and after the evaluation. Thus, the two tailed value of this test was $p = .03$; z -score = -2.34 which was significant (less than 95% CI).

Moreover, [Figure 7](#) reveals significance incremental scoring before and after the simulation demonstrations is mutual and constitutively agreed by the knowledgeable stakeholders and experts. They indicated the simulator provided less uncertainty of the emergency and disaster expectations (due to the straightforward identifications and the characteristics of the emergencies and disasters), direct failure identifications, and less risky and easier-to-conduct experimentation. The cumulative membership probability exceeded .95 and suggested that percentage agreement was almost perfect, according to Landis-Koch benchmark scale. Consequently, the Kappa agreement was 85.13 (95% CI equal to 0.527 to 1), concluded that the inter-coder agreement was significant (p -value $<.05$) and almost perfectly accepted. Prior studies indicated that agreement scoring marks more than 0.50 and between 0.667 and 0.800 indicated as reasonably significant between the research participants (Adams, Green, Clark, & Youngson, 1999; Krippendorff, 2013).

Conclusions and future work

[Figures 1, 5](#) and [6](#) are the proposed process models were validated and synthesized through the theory generation (building) techniques in order to approve key success factors of the suggested simulation modelling as cited in (Kuljis et al., 2007). Additionally, the research validation and synthesis also provided endorsement from the respective stakeholders as the expertise of the associated emergency planning frameworks. Thanks to the stakeholder's expertise acceptance had raised the usefulness of the proposed simulation model adoption. The expertise acceptance is prior to correlation of 86% average (with a 95% CI). Therefore, the disaster coordinator roles and responsibilities, resources and equipment were thoroughly defined and identified which are exceedingly demanding in Malaysia as they contributed nearly 70% of any untoward radiation and nuclear circumstances. Meanwhile, the capacity measurement analysis of the process flow stated disaster coordinator did show the bottleneck of the process activities into nearly three-quarters (72%), overly utilized by the system as cited in (Hamid et al., 2015, *Prototyping and validating*: Hamid et al., 2016).

Next, this research also significantly integrated theoretical interpretation and methodological triangulation of the case studies and simulation system development that could be mixed with other methods as described in (Pidd, 2012). As the simulator imitates real world representations, therefore, interpretive models (i.e. [Figures 1](#) and [5](#)) are conceptualized devices prior to the logical model development of the business process modelling (see [Figure 6](#)) as cited in (Pidd, 2012). These process and simulation models emphasized a chain of evidence, reliability, accuracy and representativeness as cited in (Amy Hamijah Ab. Hamid et al., 2013). They demonstrated the operational response and interconnections of the stakeholder organizations, along with radiation dose range screening, severity diagnosis and treatment of the casualties.

These output determinants supported the logical view of the specified radiological trauma triage system in regular and case-by-case care as in (Hamid et al., 2012; Hamid, Samah, et al., 2011). The sequential data collections applied constant comparisons.

Consequently, the research findings were analysed inductively into specified contexts or conditions by applying socio-technical system theories, and revealed a lack of discrepancies between data processes that need no further clarification. For instance, [Table 7](#) lists constant similarities concurrently of the defined inter-coder reliability analyses between the 'as-is' and 'to-be' models as in (Loonam & McDonagh, 2009; Urquhart, 2013).

[Figure 3](#) generates the conceptual framework of the simulator prototype design as to enable validation of the work system effectiveness of the recognized emergency planning frameworks using the socio-technical components. Furthermore, this iterative conceptualization imposing extended theoretical interpretations and requirements analysis was scaled up into the proposed simulator process flow, and capacity measurement analysis has turned into a broader theme of the simulation development (i.e. the translation and transformation of [Figures 1](#) and [5](#) into [Figure 6](#)). Occasionally, by conducting this guideline, theoretical integration was established prior to the preceding theories as cited in (Urquhart, 2013). These claims supported the stakeholder perception, whereas multiple methodologies generated deeper insights into the emergent theories. Multiple research strategies resolved the weakness of one approach to another and intensified the advantages of the chosen one. This application is also defined as another inductive coding method complemented the qualitative and interpretive research methods as cited in (Loonam & McDonagh, 2009). Consequently, the resolution of any conflicting simulation requirements is justified based on the stakeholder's agreement and acceptance in particular.

Besides, the applied requirements elicitation and analysis significantly integrated process activities as the acknowledged qualitative and interpretive methods as cited in (Hamid et al., 2013; AHA Hamid et al., 2014; Sommerville, 2007). This action was initiated to bring forward preceded theories and methods in order to transform unstructured requirements into organized workflow clusters of simulation process, agent and actors. For instance, the recommended requirements elicitation and analysis supported ISDT key concepts consisted of people, computer hardware and software, and also performed service actions according to the stakeholder's environment as cited in (Kotonya & Sommerville, 1995). The results represented adequate stakeholders and system requirements, even though they applied dynamic analytical procedures. In short, these procedures supported requirements for engineering a process efficiently and in a consistent manner.

This paper also provided socio-technical requirements elicitation to define each simulated process requirement significantly according to their context (time, place and situation) in which they are observed as cited in (Loucopoulos & Karakostas, 1995). Socio-technical requirements elicitation evaluated prominent technical problems and processes established within a social context. The requirement elicitation involved optimum stakeholders justifications gathered during the member checking sessions. Member checking sessions implemented sequential data collections of the research participants' perceptions and experts' justifications as well as during the simulator demonstration and usability test sessions. The social issues categorization in the simulator workflow relatively and interdependently associated to the technical aspect accordingly as the result of the assigned affinity analyses. These analyses supported these theoretical statements as the *T* value is lesser than the cut-off value.

This paper is comprehensive RN disaster preparedness and intervention guideline refers to the suggested conceptual framework accommodating to be a useful and efficient

computer simulation system analysis and design. The conceptual framework exhibited effective theory building techniques that complimented the simulator design and validation by integrating the requirements elicitation and analysis method. The simulator demonstrated useful implementation of an overall national disaster plan. This guideline could be applied by other emergency managers and analysts for further implementations. Future implementations could apply this guideline to other disaster and emergency phenomenon. The guideline would be initiated by specifying irradiation facilities and NPPs to be transformed into segregated categories of identified and non-identified emergencies. Future solutions of the customers' dissatisfactions must be addressed in order to decrease any severities and disorders, especially among the appointed customers. Subsequently, the next task is also to establish and address thorough time control empirically, as this is difficult to define, given current system limitations.

Acknowledgements

We are thankful to Prof. Dr Maman Djauhari for his outstanding and dedicated expertise in the Qualitative Regression Analysis (QRA) technique. We would like to convey our appreciation to Dr Faridah Mohamad Idris for her inclination to advise the author on matters regarding to nuclear physics and so forth.

Disclosure statement

No potential conflict of interest was reported by the authors.

Funding

This work was supported by Malaysia Government - UNIVERSITI TEKNOLOGI MALAYSIA: [Grant Number QJ130000.7828.4L051]; Ministry of Higher Education Malaysia Fundamental Research Funding Scheme (FRGS): [Grant Number 4F550]; Universiti Teknologi Malaysia: [Grant Number 02G31].

Notes on contributors

Amy Hamijah Ab. Hamid is a Senior Research Officer at Information Technology Center, Technical Support Division of Malaysian Nuclear Agency (Agensi Nuklear Malaysia) under the Malaysian Ministry of Science, Technology and Innovation (MOSTI) since 2001. She is graduated with Doctor of Philosophy in Information Systems from Universiti Teknologi Malaysia in 2016. She is also received Masters in Information Technology degree from Universiti Kebangsaan Malaysia in 2002, Bachelor Degree in Public Management (Hons.) from Universiti Utara Malaysia in 1999 including Diploma in Public Administration from Universiti Teknologi MARA, Malaysia in 1995. Her research interests involved theoretical beneficence and applications in information systems, software engineering, as well as the business continuity (ISO 22301) and information security (ISO 27001) management.

Mohd Zaidi Abd Rozan, is an Associate Professor, Department of Information Systems, Faculty of Computing since 2016, where he is a Senior Lecturer since 2009 and Lecturer since 2002. He has B.Sc. (Physics). Comp. Ed and M.Sc. (IT) in Universiti Teknologi Malaysia and received D. Eng. in Information Science and Control Engineering from Nagaoka University of Technology, Japan in 2007. He has worked and held various positions from academic and non-academic organizations. He is currently appointed as the manager of UTM Technology Entrepreneurship Center (UTMTEC) as his main interest is in entrepreneurship. Moreover, he is Certified Project Management PRINCE2

Practitioner, Microsoft Certified Technology Specialist (Microsoft Office Project 2007), OBASHI Registered, and MNCC Certificate of Business and Systems Analysis as well. Above all, he is a member of automobile engineering and safety organizations such as Society of Automobile Engineering (SAE), USA, Kansei Engineering and Japan Traffic Safety Association.

Roliana Ibrahim is an Associate Professor and also the Head of the Information Systems Department, Faculty of Computing in Universiti Teknologi Malaysia (UTM). She received her B.Sc. (Hons.) Computer Studies from Liverpool John Moores University, M.Sc. Computer Science from Universiti Teknologi Malaysia and PhD in the field of Systems Engineering from Loughborough University. She has been an academic staff at Information Systems Department for since 1999 and was previously a Coordinator of B.Sc. Computer Science (Bioinformatics) Program and Master of Information Technology (IT Management).

Safaai Deris is a Professor at Faculty of Technology Creative and Heritage University Malaysia Kelantan. He was a Professor of Artificial Intelligence and Software Engineering at the Faculty of Computing, Universiti Teknologi Malaysia. He is the Chief Information Officer and Director of the Center for Information and Communication Technology. His previous positions include Deputy Dean of School of Graduate Studies and Head of Software Engineering Department. He is also Head of Artificial Intelligence and Bioinformatics Research Group. He received the M. Eng. degree in Industrial Engineering, and the D. Eng. degree in Computer and System Sciences, both from the Osaka Prefecture University, Japan. His research interests include the software engineering, applications of intelligent techniques in planning, scheduling, bioinformatics and system biology.

Ali Selamat has received a B.Sc. (Hons.) in Information Technology from Teesside University, UK and M.Sc. in Distributed Multimedia Interactive Systems from Lancaster University, UK in 1997 and 1998, respectively. He has received a Dr Eng. Degree from Osaka Prefecture University, Japan in 2003. He is currently a professor at Department of Software Engineering, Faculty of Computing, Universiti Teknologi Malaysia, Malaysia. He is also currently a Chief Information Officer (CIO) and Director of Computer and Information Technology, Universiti Teknologi Malaysia (UTM). He was the Dean of Research, Knowledge Economy Research Alliance, UTM. He is also the Editorial Boards of Knowledge Based Systems, Elsevier, International Journal of Information and Database Systems (IJIDS), Inderscience Publications, Vietnam Journal of Computer Science, Springer Publications, Advances in Distributed Computing Intelligence Journal (ADCAIJ), Salamanca University Press. He is the Program Chair of International Conference on Software Engineering Tools, Methodologies (SOMET), 2017 to be held in Kanazawa, Japan. He has been a visiting professor at Hradec-Kralove University of Czech Republic, Kuwait University, and few others universities in Japan. His research interests include cloud based software engineering, software agents, information retrievals, pattern recognition, genetic algorithms, neural networks, and soft-computing, knowledge management, and key performance indicators.

Muhd. Noor Muhd. Yunus graduated from Universiti Teknologi Malaysia in Mechanical Engineering in 1979. Furthermore, he pursued his Master's and PhD Degrees in Chemical Engineering for Combustion and Pollution Controls in 1991 and Flue Gas Treatment Using Activated Carbon in 1995 from University of Sheffield, UK. His career started with PUSPATI (currently known as Malaysian Nuclear Agency) as a research officer in 1979. He is further appointed as Deputy Director General (Technical) from 2007 to 2011 which then promoted to Deputy Director General (R&D) in 2011 till his retirement in 2015. He was the national expert in waste management, in particular incineration technology which involved national governance and international expertise for Republic of Korea International Combustion, Incineration, Pollution and Emission Controls Seminars (ICIPEC) and Sheffield University Waste Incineration Center (SUWIC). Above all, his major involvement in R&D for nuclear science and technology plays an important role and contributes to the implementation and realization of national science and technology (S&T) policies to ensure that it remains a relevant public research and development institute. Deliberately, he was also the advisor for Director General of International Atomic Energy Agency (IAEA), member of the Standing Advisory Group on Nuclear Energy (SAGNE), and also national coordinator via advisor in Forum for Nuclear Cooperation Asia (FNCA) and Malaysia Nuclear Power Cooperation (MNPC).

ORCID

Ali Selamat  <http://orcid.org/0000-0001-9746-8459>

References

- Adams, E. J., Green, J. A., Clark, A. H., & Youngson, J. H. (1999). Comparison of different scoring systems for immunohistochemical staining. *Journal of Clinical Pathology*, *52*, 75–77. doi:10.1136/jcp.52.1.75
- Aguilar-Saven, R. S. (2004). Business process modelling: Review and framework. *International Journal of Production Economics*, *90*(2), 129–149.
- Anupindi, R., Chopra, S., Deshmukh, S. D., Mieghen, J. A. M., & Zemel, E. (2006). *Managing business process flows: Principles of operations management* (2nd ed.). Cranbury, NJ: Pearson Education.
- Asgary, A., & Mousavi-Jahromi, Y. (2011). Power outage, business continuity and businesses' choice of power outage mitigation measures. *American Journal of Economics and Business Administration*, *3* (2), 307–315.
- Avison, D., & Fitzgerald, G. (2006). *Information systems development: Methodologies, techniques and tools* (4th ed.). Boston, MA: McGraw-Hill Education (UK).
- Borshchev, A. (2013). *Multi-method modeling*. Paper presented at the Proceedings of the 2013 Winter Simulation Conference.
- Chan, C. S. A. (1998). *An overview of job hazard analysis technique*. Beijing: Progress in Safety Science and Technology, Science Press.
- Crutchfield, N., & Roughton, J. (2008). *Job hazard analysis: A guide for voluntary compliance and beyond*. Oxford: Elsevier and Butterworth-Heinemann.
- Feldman, M. S., & Orlikowski, W. J. (2011). Theorizing practice and practicing theory. *Organization Science*, *22*(5), 1240–1253. doi:10.1287/orsc.1100.0612
- Gunes, G. (2014). *Agent-based simulation and an example in anylogic*. Istanbul: Yildiz Technical University.
- Hamid, A. H. A., Rozan, M. Z. A., Deris, S., & Ibrahim, R. (2013). Business process analysis of emergency plan using work system theory. *Journal of Information Systems Research and Innovation (JISRI)*, *3*, 37–43.
- Hamid, A. H. A., Rozan, M. Z. A., Deris, S., Ibrahim, R., Rahman, A. A., Selamat, A., ... Yunus, M. N. M. (2015a). *Business process based requirements modeling of radiological trauma triage capacity planning framework*. Paper presented at the 4th International Conference on Research and Innovation in Information Systems (ICRIIS2015), Malacca.
- Hamid, A. H. A., Rozan, M. Z. A., Deris, S., Ibrahim, R., Rahman, A. A., Selamat, A., ... Yunus, M. N. M. (2015b). Business process based requirements modeling of radiological trauma triage capacity planning framework. *ARPN Journal of Engineering and Applied Sciences*, *10*(23), 17624–17631.
- Hamid, A. H. A., Rozan, M. Z. A., Ibrahim, R., Deris, S., & Selamat, A. (2015). *Prototyping and validating requirements of radiation and nuclear emergency plan simulator*. *Advancing of Nuclear Science and Energy for National Development: Proceedings of the Nuclear Science, Technology, and Engineering Conference 2014 (NuSTEC2014)*, 1659. doi:10.1063/1.4916848
- Hamid, A. H. A., Rozan, M. Z. A., Ibrahim, R., Deris, S., Selamat, A., & Yunus, M. N. M. (2015). Requirements engineering of Malaysia's radiation and nuclear emergency plan simulator. *Intelligent Software Methodologies, Tools and Techniques Communication in Computer and Information Science*, *513*, 83–97. doi:10.1007/978-3-319-17530-0_7
- Hamid, A. H. B. A., Rozan, M. Z. A., Deris, S., Ibrahim, R., Samah, A. A., & Hashim, S. (2011, July 12–14). *Categories for vulnerable groups using system dynamics simulation modelling*. Paper presented at the Sixth International Symposium on Radiation Safety and Detection Technology (ISORD-6), Awana Porto Malai, Langkawi, Kedah, Malaysia.
- Hamid, A. H. B. A., Samah, A. A., Majid, H. A., Anwar, S., Rozan, M. Z. A., Deris, S., ... Hashim, S. (2011, November 23–24). *Recommended factors for triage categories using simulation modelling*. Paper presented at the International Conference on Research and Innovation in Information Systems (ICRIIS'11) Seri Pacific Hotel, Kuala Lumpur.

- Hamid, A. H. B. A., Wah, L. K., Majid, H. A., Samah, A. A., & Abdullah, W. S. W. (2012, March 27–28). *Towards the development of an absorbed dose range detection and treatment simulation system to manage the healthcare consequences of a nuclear accident in Malaysia*. Paper presented at the Operational Research Society Simulation Workshop 2012 (SW12), Worcestershire, UK.
- Hamid, A., Rozan, M., Ibrahim, R., Deris, S., & Yunus, M. (2014). Framing a nuclear emergency plan using qualitative regression analysis. *Journal of Nuclear and Related Technologies (JNRT)*, 11(1), 28–47.
- Hamid, A. H. A., Deris, M. Z. A. R., S., Ibrahim, R., Abdullah, W. S. W., Rahman, A. A., & Yunus, M. N. M. (2016). *Analyzing and sense making of human factors in the Malaysian radiation and nuclear emergency planning framework*. *Advancing Nuclear Science and Engineering for Sustainable Nuclear Energy Infrastructure: Proceeding of the International Nuclear Science, Technology and Engineering Conference (iNUSTEC2015)*, 1704. doi:10.1063/1.4940104
- Hoang, V.-D. (2017). Multiple classifier-based spatiotemporal features for living activity prediction. *Journal of Information and Telecommunication*, 1(1), 100–112. doi:10.1080/24751839.2017.1295668
- International Atomic Energy Agency. (1988). *The radiological accident in Goiania* (pp. 149). Vienna: Author.
- International Atomic Energy Agency. (1998a). *Safety report series No. 2*. Vienna: Author.
- International Atomic Energy Agency. (1998b). *Safety report series No. 4*. Vienna: Author.
- Jabatan Perdana Menteri. (2010). *Economic transformation programme: A roadmap for Malaysia (1 Malaysia)*. Kuala Lumpur: Performance Management and Delivery Unit (PEMANDU).
- Kaoru Ishikawa. (1990). Introduction to quality control. Retrieved from <http://www.worldcat.org/oclc/61341428>
- Kotonya, G., & Sommerville, I. (1995). Requirements engineering with viewpoints (C. Department, Trans.). In C. S. E. Group (Ed.), *Technical report: CSEG/10/1995* (pp. 1–26). Lancaster: Lancaster University.
- Krippendorff, K. (2013). *Content analysis: An introduction to its methodology* (3rd ed.). Los Angeles, CA: Sage.
- Kuljis, J., Paul, R. J., & Stergioulas, L. K. (2007). *Can health care benefit from modeling and simulation methods in the same way as business and manufacturing has?* Paper presented at the 2007 Winter Simulation Conference, Washington, DC, USA.
- Loonam, J., & McDonagh, J. (2009). A grounded theory study of enterprise systems implementation: Lessons learned from the Irish health services. In A. Cater-Steel & L. Al-Hakim (Eds.), *Information systems research methods, epistemology and applications* (pp. 58–72). Hershey: IGI Global.
- Loucopoulos, P., & Karakostas, V. (1995). *Systems requirements engineering*. London: The McGraw-Hill International Series in Software Engineering.
- Pidd, M. (2009). *Tools for thinking: Modelling in management science*. Chichester: Wiley.
- Pidd, M. (2012). *Mixing other methods with simulation is no big deal*. Paper presented at the Proceedings of the 2012 Winter Simulation Conference.
- Russell, R. S., & Taylor, III, B. W. (2011). *Operations management*. Hoboken, NJ: Wiley.
- Sommerville, I. (2007). *Software engineering* (8th ed.). Harlow: Addison-Wesley.
- Subbiah, A., & Ibrahim, O. (2011, November 23–24). *Implementing affinity analysis in determining critical factors on e-service systems in Malaysia*. Paper presented at the 2011 International Conference on Research and Innovation in Information Systems (ICRIIS), Kuala Lumpur.
- Tague, N. R. (2004). *Seven basic quality tools the quality toolbox*. Milwaukee, WI: American Society for Quality.
- Urquhart, C. (2013). *Grounded theory for qualitative research: A practical guide*. Los Angeles: Sage.
- Waller, E., Millage, K., Blakely, W. F., Ross, J. A., Mercier, J. R., Sandgren, D. J., & Disraelly, D. S. (2009). Overview of hazard assessment and emergency planning software of use to RN first responders. *Health Physics The Radiation Safety Journal*, 97(2), 145–156.