

## The Effect of Plasma-Treated Boron Nitride on Partial Discharge Characteristics of LDPE

N.A. Awang, M.H. Ahmad, Y.Z. Arief, I. H. Zakaria, N.A. Ahmad

Institute of High Voltage & High Current (IVAT), Faculty of Electrical Engineering, Universiti Teknologi Malaysia, 81310 Johor Bahru, Malaysia

---

### Article Info

#### Article history:

Received Jun 9, 2016

Revised Nov 20, 2016

Accepted Dec 11, 2016

---

#### Keyword:

Atmospheric pressure plasma

Boron nitride

CIGRE method II

Low density polyethylene

Partial discharge

---

### ABSTRACT

Power supply reliability is a key factor in a country economic stability. It is contributed by the reliable power distributor via transmission lines, overhead or underground cables. However, the power cables and accessories are always exposed to pre-breakdown phenomena known as partial discharges (PD) which commonly occur in microvoids, defects or protrusions inside the insulation. To improve the performance of the cable insulation against PD, nanofillers are added into the insulating materials. However, to achieve superior performance of PD resistance, the nanofillers must be homogeneously dispersed into the polymer matrices with tightly bonded interfacial zones. Therefore, this could be achieved by employing method of surface functionalization by using cold atmospheric plasma to strengthen the filler/polymer interfaces. In view of foregoing, this study investigated the effects of surface treated boron nitride (BN) nanoparticles in Low Density Polyethylene (LDPE) on the PD characteristics by following CIGRE Method II at 7 kVrms applied voltage. The phase resolved PD characteristics were performed. The results revealed that by treating the nanofillers with cold plasma, the PD resistance of LDPE were highly achieved compared with the untreated BN nanofillers.

Copyright © 2017 Institute of Advanced Engineering and Science.  
All rights reserved.

---

### Corresponding Author:

M.H. Ahmad,

Institute of High Voltage & High Current,

Faculty of Electrical Engineering,

Universiti Teknologi Malaysia

Email: mohdhafizi@fke.utm.my

---

### 1. INTRODUCTION

Polymeric insulating materials are widely used in high voltage equipment, especially in power cables. However, under long period, polymeric cables which exposed to the ageing and degradation will eventually lead to electrical failure. One of the main causes of electrical failure in insulation cables is partial discharge. Partial discharge (PD) is defined as a localized dielectric breakdown of a small portion of an insulation solid or fluid that partially bridge the insulation between the conductors which may or may not occur adjacent to a conductor [1]. Thus, PD phenomenon needs to be considered in insulation diagnostics and performance assessment measurement. Since this phenomenon only occurs within the defect in the insulation, it does not cause a direct breakdown of the insulation immediately [2]. Failures in high voltage components due to insulation breakdown can result in costly and time consuming maintenance as the whole component may need to be replaced. Therefore, one of the methods against PD is by adding nanofillers into the polymer to reduce the PD activities in polymeric insulation. However, the nanofillers tend to agglomerate in polymer matrices due to their incompatibility. The homogeneous dispersion and good adhesion of the nanoparticles cannot be achieved thereby leading to properties degradation of the power cable insulation. As a solution, coupling agent was used to modify the surface of the nanoparticles chemically. This method has shown some promising results by improving the interfacial bonding [3], but this technique still has some

common drawbacks such as complexity and high toxicity due to the use of chemical solvents [4].

In order to enhance the dielectric performance of polymer nanocomposites, a surface modification method via atmospheric pressure plasma (APP) was employed. APP has been successfully employed in some fields such as etching, surface activation, ozone production and decontamination [5]. Yan et al. [6-8] found that the surface modification using plasma treatment method reduced the agglomeration and improved the chemical bonds thereby leading to the improvement of the electrical insulation properties. In this study, atmospheric pressure plasma method was used by treating the BN nanofillers with plasma discharges. This technique could be an optimum solution to the production of highly PD resistant insulation for high voltage application especially in power cables.

## 2. EXPERIMENT AND TEST OBJECTS

### 2.1. Sample Preparation

The LDPE was used as base polymer of the polymer nanocomposite sample. It was supplied by Titan Chemical, Malaysia. It has density of  $0.922\text{g/cm}^3$  and the melting index of  $25\text{g}/10\text{min}$ . Also, the nanofiller used was Boron Nitride. Boron Nitride was hexagonal shape with average particle size of  $137\text{nm}$  supplied by Nanostructured and Amorphous Materials, USA.

Compounding process of LDPE and BN filler was performed using a Brabender mixer with the chamber size of  $50\text{cm}^3$  by melt mixing at  $165^\circ\text{C}$ . The electrode speed mixer has a high shear force and it was controlled at  $35\text{rpm}$  to ensure the mixing process was mixed homogeneously between polymer and the nanofillers. The mixing time of LDPE and the nanofillers was set at 2 minutes for each sample.

The samples of LDPE nanocomposites were prepared into square shape with dimension of  $15\text{cm} \times 15\text{cm} \times 1\text{mm}$  by hot pressing at  $160^\circ\text{C}$ . Preheating process was conducted for 5 minutes followed by 5 minutes of compression. After that, the moulded sample was placed inside the hydraulic cold press machine for cooling process.

### 2.2. Surface Modification using Plasma

The BN nanofillers were modified using atmospheric pressure plasma in utilizing the concept of dielectric barrier discharge (DBD) configuration system. The DBD of plasma setup consists of two glass plates in between of the high voltage electrode covered with wire mesh as shown in Figure 1. The atmospheric air pressure plasma was generated by a  $50\text{Hz}$  power supply with a maximum  $10\text{kVrms}$  applied voltage. The plasma power was consumed at  $10\text{W}$ . The nanoparticles were placed between DBD's plate in the plasma chamber and treated time was performed for 30 minutes. To obtain a homogeneous exposure, the nanoparticles were stirred for 30 seconds at every 5 minutes of surface treatment [6]. Table 1 shows the sample code and composition of each sample.

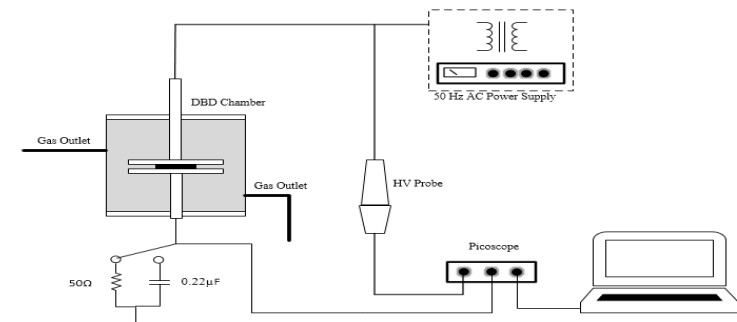

Figure 1. Atmospheric Pressure Plasma Reactor

Table 1. Code and Composition of each Sample

| Sample code | Composition  |
|-------------|--|
| A0          | Pure Low Density Polyethylene  |
| B1          | Low Density Polyethylene/5wt% Untreated Boron Nitride Nanocomposite      |
| B2          | Low Density Polyethylene/5wt% Plasma Treated Boron Nitride Nanocomposite |

### 2.3. CIGRE Method II Electrode Configuration

The high voltage was applied at the upper of the sphere electrode of the test cell and also the molded sphere electrode with specimen that was fabricated by using LDPE at the centre of the CIGRE Method II. Then, the nanocomposite sample and kapton spacer were put at the bottom of the specimen. The rod electrode was directly contacted with the specimen, while the specimen and the ground electrode were separated by a gap of about 0.125mm. This is to ensure a strong and inhomogeneous field in the cavity, thus concentrating the discharge area with a radius about twice of the sphere as shown in Figure 2.

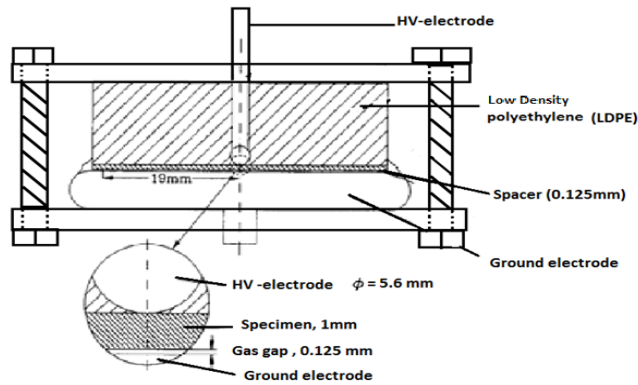

Figure 2. CIGRE Method II electrode configuration

### 2.4. Characterization and Partial Discharge Testing

The Field Emission Scanning Electron Microscopy (FESEM) analyses of each sample were performed using a Zeiss Supra 35VP scanning electron microscope to observe the dispersion and the homogeneity of BN nanoparticles in the samples of the untreated and plasma treated nanocomposites.

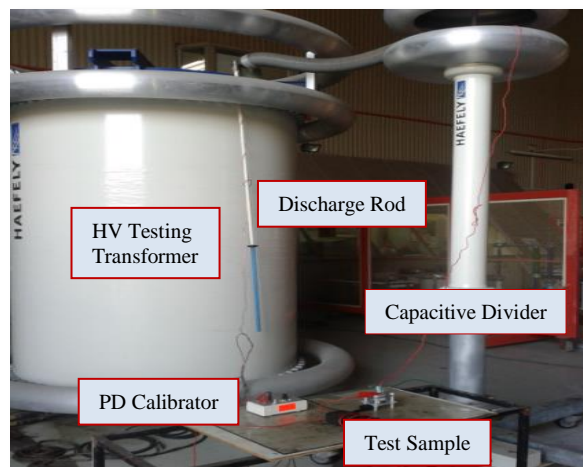

Figure 3. Experimental setup for the PD measuring system

The PD experiment setup was conducted in High Voltage Laboratory as shown in Figure 3. PD test has followed the IEC 60270: 2000 standard [9] including preparation of measurement tools as a standard of solid insulating material which stated that the AC voltage of 50 Hz power supply needed to be injected in the solid insulation. This standard was designed with the purpose of characterizing the ability of insulating material that to prevent the inception of partial discharges when they are subjected to high electrical stresses. The voltage was applied up to 7 kVrms for 1 hour ageing time of each LDPE nanocomposites sample. Besides that, the PD measurement setup had the background noise level at 0.25 pC.

### 3. RESULTS AND ANALYSIS

#### 3.1. Partial Discharge Characteristics

Partial discharge occurrences of pure LDPE and LDPE/BN nanocomposites with 5wt% for 1 hour were measured. This charge pulse obtained during the testing samples of PD characteristics in High Voltage laboratory. Based on the experiment, the results obtained by using PD Detector DDX-9101 Remote Control software was set at 7 kV<sub>rms</sub> voltage level during the ageing process.

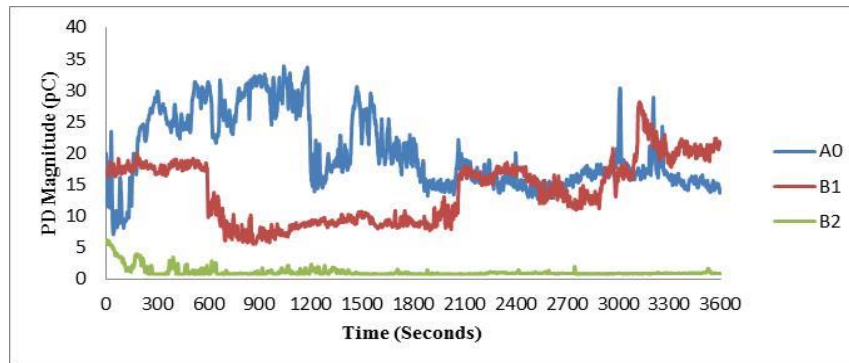

Figure 4. PD magnitude pattern over one hour ageing time at 7kV<sub>rms</sub>

Figure 4 depicts the PD magnitude patterns over one hour ageing time of all samples for PD experiment test. As clearly seen from the figure, the A0 sample has higher PD magnitude value at 300 second and B2 sample has the lowest PD magnitude among other samples. Meanwhile, the occurrences of PD activities started to fluctuate at 2100 seconds between A0 and B1 sample. This phenomenon is considered as electromagnetic interference that occurs during experiment. The results in Figure 5 showed that the average of PD magnitude that influenced by the value of voltage stress exerted on the sample. It has happened at a critical value of high voltage, the void would experience a PD activity which caused by the breakdown voltages within the cavity.

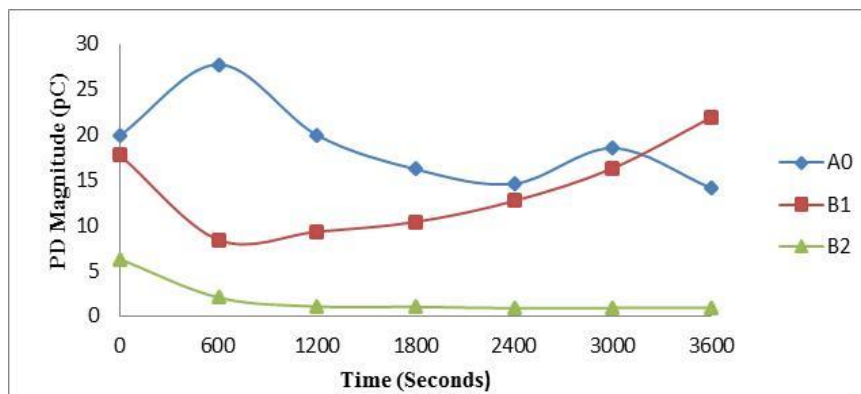

Figure 5. Average of PD magnitude over one hour ageing time at 7kV<sub>rms</sub>

The value of breakdown voltage occur in the void was initiated at some value of voltage in excess of the nominal breakdown voltage of the sample. The occurrences of PD at higher nanofiller amount had a smaller charge as compared to the sample without nanofiller. The overall PD patterns start to change during 1 hour of ageing time. At the first 600 seconds, the PD magnitude of the B2 sample shows a significant decrease that resulted in the lowest PD magnitude among the three samples. However, for last 600 seconds, the PD magnitude of the B1 sample increased abruptly up to 23 pC compared to other samples. It may be associated with electromagnetic interference.

Statistical analysis was applied for the computation of several statistical operators. The definitions of most of these statistical operators are described below. The phase angle  $\phi$ , PD charge magnitude  $q$  and PD

number of pulses  $n$ . PD distribution patterns are composed of these three parameters. Statistical parameters are obtained for phase resolved pattern (n-q). During the experiment of partial discharge, a small green point represents the PD activities that occurred of each sample. From the NQP patterns in Figure 6, the PD occurred between zero crossing and the peak of both half cycles. In average, the amplitude of the pattern is similar in A0 and B1 samples but the PD number of A0 sample has the higher value among others. The sample with addition of nanofiller has the layer that prevents the sample from the occurrences of PD. Therefore, it may reduce the PD number and also the PD occurrences. While, the NQP pattern for B2 sample was significantly different because it has a lower PD magnitude and PD number. It can be seen in Figure 8(b), the agglomeration has occurred in the plasma treatment obtained with a filamentary discharge. It resulted in a few parts which exposed to the plasma treatment at the surface compared to the other parts thereby resisting the PD discharges. Agglomeration of nanoparticles contributes to the high repetition of PD activities in term of PD number. However, plasma treatment produced stronger chemical bonds and could improve the dispersion level of the nanoparticles.

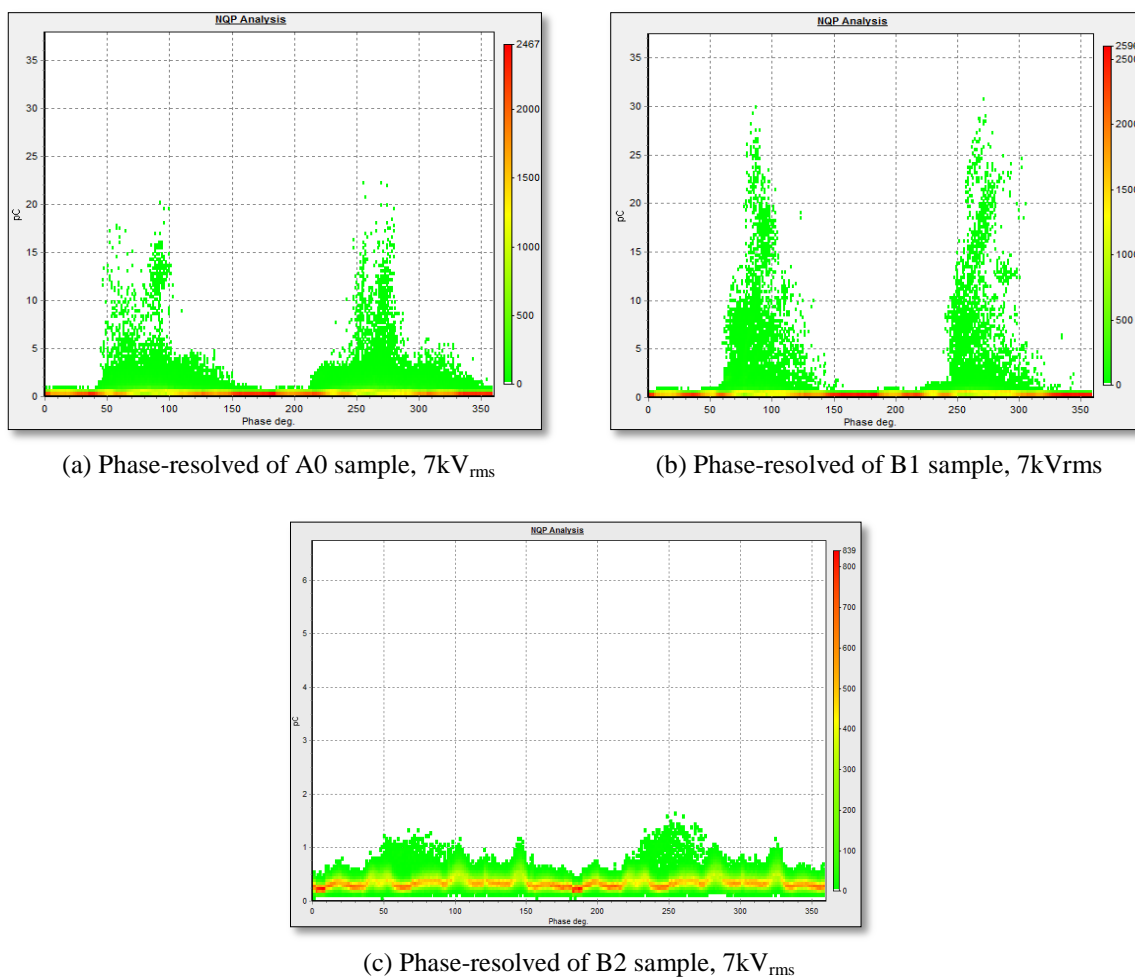

Figure 6. NQP pattern of LDPE-BN nanocomposite

### 3.2. Morphological Analysis

The FESEM analysis of untreated and plasma treated nanoparticles and nanocomposite samples were carried out as shown in Figures 7 and 8, respectively.

It can be seen in Figure 7(b), the treated of nanoparticles has uniform and smoother surface because of plasma coating compared to the untreated sample. In addition, there are less nanoparticles accumulation after plasma treatment. The formation of the agglomeration in the untreated nanoparticles compared to the plasma treated nanoparticles. Overall, there are no obvious morphological changes occurred between untreated and treated nanoparticles.

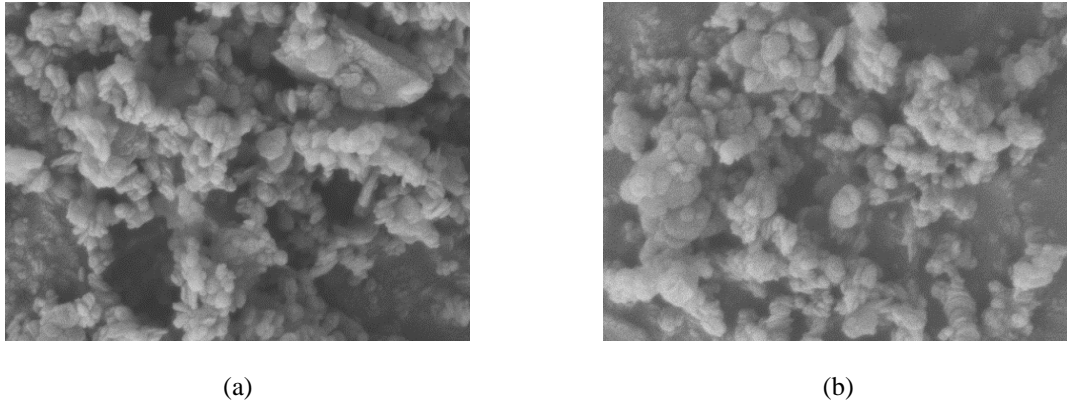

Figure 7. FESEM images of (a) untreated BN nanoparticles and (b) plasma treated BN nanoparticles

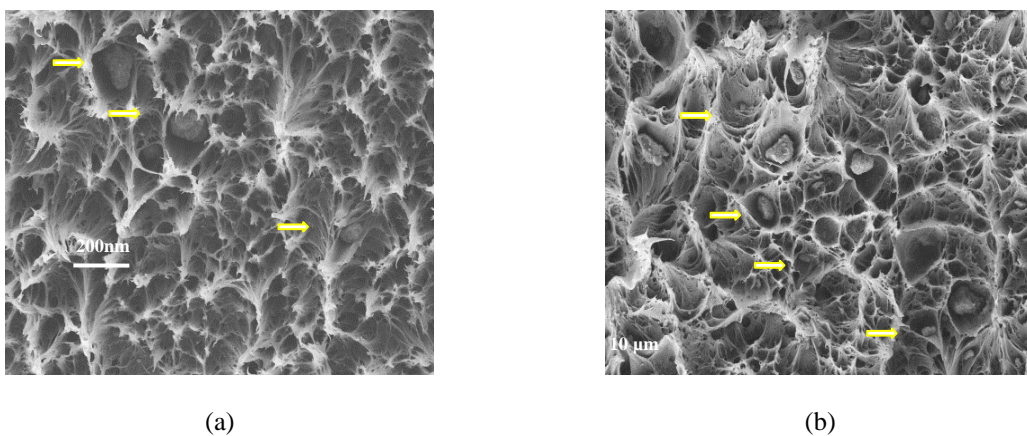

Figure 8. FESEM images of cross-section of (a) untreated LDPE and (b) plasma treated LDPE nanocomposites

Moreover, the cross-sectional FESEM images of the untreated and plasma treated LDPE nanocomposite samples are depicted in Figure 8. Observation shows that the agglomeration still occurs in the nanocomposite sample even with plasma treated nanoparticles. However, the sizes of cluster are relatively smaller than that in nanocomposite with untreated nanoparticles. This happens because of the average particle size of BN (137 nm) is relatively bigger than requirement nanoparticle size which is less than 100 nm. Also, 5wt% of the nanofiller concentration used in this study is considered as large amount thereby leading to the high rate of agglomeration of the nanoparticles [10].

#### 4. CONCLUSION

The PD measurements and analysis of the untreated and plasma treated LDPE nanocomposites were performed successfully. The results revealed that the plasma treated sample exhibited better PD resistance in terms of lower PD magnitude as compared to the untreated sample. In addition, some improvement of PD characteristics by modifying the surface of nanoparticles using atmospheric pressure plasma has been investigated. As a result, the PD resistance has been improved significantly by adding plasma treated nanofillers.

#### ACKNOWLEDGEMENTS

The authors would like to acknowledge Universiti Teknologi Malaysia (UTM) and the Ministry of Higher Education (MOHE), Malaysia for the Research Grants; Vot 4F599, Vot 13H98 and Vot 4F672 for financial support during this research work.

## REFERENCES

- [1] E. Lemke, S. Berlijn, E. Gulski, M. Muhr, E. Pultrum, T. Strehl, W. Hauschild, J. Rickmann, and G. Rizzi, "Guide for Electrical Partial Discharge Measurements on Compliance to IEC 60270", *Electra*, no. 241, pp. 61–67, 2008.
- [2] Y.Z. Arief, W.A. Izzati, and Z. Adzis, "Modeling of Partial Discharge Mechanisms in Solid Dielectric Material", *Int. J. Eng. Innov. Technol.*, vol. 1, no. 4, pp. 315–320, 2012.
- [3] Y. Xie, C.S. Hill, Z. Xiao, H. Militz, and C. Mai, "Silane coupling agents used for natural fiber/polymer composites: A review", *Compos. Part A Appl. Sci. Manuf.*, vol. 41, no. 7, pp. 806–819, 2010.
- [4] F.N. Musa, N. Bashir, M.H. Ahmad, Z. Buntat, "Electrical treeing in high voltage insulations: a review on nanocomposite insulating materials and their processing techniques", *J. Optoelectron. Adv. Mater.*, vol. 17, no. 3, pp. 462–476, 2015.
- [5] U. Kogelschatz, "Dielectric-Barrier Discharges: Their History, Discharge Physics, and Industrial Applications", *Plasma Chem. Plasma Process.*, vol. 23, no. 1, pp. 1–46, 2003.
- [6] W. Yan, Z.J. Han, B.T. Phung, and K.K. Ostrikov, "Silica nanoparticles treated by cold atmospheric-pressure plasmas improve the dielectric performance of organiceinorganic nanocomposites", *ACS Appl. Mater. Interfaces*, vol. 4, no. 5, pp. 2637–2642, 2012.
- [7] Wei Yan, B.T. Phung, Zhaojun Han, and K. Ostrikov, "Reinforced insulation properties of epoxy resin/SiO<sub>2</sub> nanocomposites by atmospheric pressure plasma modification", in *2012 IEEE International Power Modulator and High Voltage Conference (IPMHVC)*, 2012, pp. 391–394.
- [8] W. Yan, B. T. Phung, Z. J. Han, K. Ostrikov, and T. R. Blackburn, "Partial discharge characteristics of epoxy resin-based nanocomposites fabricated with atomospheric plasma treated SiO<sub>2</sub> nanoparticles", in Proceedings of 2011 International Symposium on Electrical Insulating Materials, 2011, pp. 353–357.
- [9] IEC Standard. High -voltage test techniques-Partial discharge measurements, IEC 60270:2000.2001
- [10] I. Ozroy, A. Demirkol, A. Mimaroglu, H. Unal, and Z. Demir, "The Influence of Micro- and Nano-filler Content on the Mechanical Properties of Epoxy Compossites", *Journal of Mechanical Engineering*, Vol. 61, No. 10, pp. 601-609, 2015.

## BIOGRAPHIES OF AUTHORS



**Noor 'Aliaa Awang** was born in Kelantan, Malaysia on June 29, 1989. She received her Electrical Engineering (Education) diploma degree from Universiti Tun Hussein Onn Malaysia (UTHM), Johor in 2010 and received B.Eng in Electrical Engineering with Honors from UTHM in 2013. She then completed her M.Eng degree in electrical power engineering from Universiti Teknologi Malaysia (UTM) in 2015. She is currently pursuing Ph.D. degree at Institute of High Voltage and High Current (IVAT) in Faculty of Electrical Engineering, UTM. Her research interests include the partial discharges phenomenon and polymer nanocomposites insulating materials.



**Mohd Hafizi Ahmad** received his B. Eng. and PhD degrees in Electrical Engineering from UTM, Malaysia in 2009 and 2013 respectively. Formerly, he was visiting researcher in the University of Leicester, UK, Sriwijaya University, Indonesia and Tanjungpura University, Indonesia within 2010 and 2012. He worked as a tutor in the Faculty of Electrical Engineering, UTM from 2009-2013. Currently, he works as a senior lecturer in the Institute of High Voltage and High Current, Faculty of Electrical Engineering, UTM. His research interests cover different types of high voltage insulation (solid, liquid and gas), nanodielectrics, insulation performance and breakdown of dielectric materials.



**Yanuar Z. Arief** obtained his B. Eng. degree from Tanjungpura University, Indonesia in 1994. Also, he received the M. Sc. degree from the Bandung Institute of Technology, Indonesia in 1998 and PhD from Kyushu Institute of Technology, Japan in 2006 and also Post-Doctoral from University of Siegen, Germany. Currently, he is a senior lecturer in the Institute of High Voltage and High Current, Universiti Teknologi Malaysia, Johor, Malaysia. His research interests include partial discharge detection and degradation phenomena of polymeric insulating materials.



**Izzah Hazirah Zakaria** received the Diploma in Electrical Engineering from Universiti Malaysia Perlis (UniMAP), Perlis in 2010 and received B.Eng in Electrical Engineering with Honors from UTHM in 2013. She received the M.Eng degree in electrical power from Universiti Teknologi Malaysia (UTM) in 2015. She is currently pursuing Ph.D. degree at Institute of High Voltage and High Current (IVAT) in Faculty of Electrical Engineering, UTM. Her research interest includes the electrical discharges, nanodielectrics and nanofluid.



**Noor Azlinda Ahmad** received her B.Eng. (Electrical) and M. Eng. (Electrical) Degree from Universiti Teknologi Malaysia in 2001 and 2003, respectively. She completed her PhD in Atmospheric Discharge from Uppsala University, Sweden in 2011. At present she is a lecturer at Institute of High Voltage and High Current (IVAT) Universiti Teknologi Malaysia. Her major research interests are lightning protection, measurement, detection and characterization.