

Superaugmented Pitching Motion of UTM CAMAR UAV using Advanced Flying Handling Qualities

Open
Access

Shuhaimi Mansor^{1,*}, Yasser Nogoud^{1,2}, Shabudin Mat¹, Md. Nizam Dahalan¹, Ainullotfi Abdul-latif¹

¹ Department of Aeronautical, Automotive and Offshore Engineering, University Teknologi Malaysia, 81310 Johor Bahru, Malaysia

² Sudan University of Science and Technology, Sudan

ARTICLE INFO

ABSTRACT

Article history:

Received 2 November 2017

Received in revised form 1 December 2017

Accepted 24 December 2017

Available online 26 December 2017

This paper focused of a robust flight control system (FCS) for a small UAV. The main objective of this design is to ensure the small UAV can fly safely in severe gusty conditions. The Superaugmentation FCS consisted of Stability Augmentation System (SAS) and Command Stability Augmentation System (CSAS) was developed in UTM-LST to improve the dynamic characteristics of the longitudinal stability of UAV; i.e UTM Camar. A combination of the variable stability technique along with advanced flying and handling qualities (FHQ) requirements are used to reduce the gust effect on the aircraft or UAV. The results obtained from the simulation studies showed that the supraugmented aircraft can be operated in severe gust environments than augmented aircraft. The result from here has reduced strain on the elevator activity in both extreme and calm weather conditions. Moreover, the supraugmentation FCS in the longitudinal axis meets the requirements of the level 1 handling qualities specification in flight phase.

Keywords:

Delta Wing UAV, Propeller, Vortex, Wind

Tunnel Experiment, Surface Pressure

Copyright © 2017 PENERBIT AKADEMIA BARU - All rights reserved

1. Introduction

Unmanned Aerial Vehicles (UAVs) became widely used in civil and military applications due to their versatility and the fact that they represent no risk to their operators. The demand for improvement of performance, stability and efficiency of the UAV is an important and continuous research topic for the future. Much work has been done for improvement of flight control for the small UAVs to increase their safety and reliability during flight [1, 2]. However, the performance of the small UAV in the gusty wind condition is still suffering comparing to the large aircraft. This is because it has low inertia so that a disruption gust can change its attitude very quickly [3]. Besides that, it has low velocity so turbulences and gusts can change its airspeed flight condition dramatically over a very short period, resulting in unwanted motion. Up to this point, it seems that there is a significant design trade-off between an aircraft's ability to fly in gusty conditions and its size. A small UAV is desirable for some reasons such as low cost, safe to fly over urban due to the low probability of injury or fatality in case of crash, because of the small amount of kinetic energy

* Corresponding author.

E-mail address: shuhaimi@utm.my (Shuhaimi Mansor)

that it has but is obviously harder to operate in turbulence. This visible compromise strictly limits the aircraft that can be used for these types of missions.

For this reasons, the flight control systems have to be designed to avoid these undesirable events. Most of small UAV Flight control systems make use of low-cost commercial-off-the-shelf flight control system. Most of these systems use classical Proportional-integral-derivative (PID) controllers where ad-hoc methods are used to tune the controller gains in flight. This methodology is time-consuming and high-risk [4]. Besides that, little attention has been spent on the assessment of flying and handling quality standards. Although awareness of UAV design requirements, elaboration of flying and handling qualities is one of the major steps which will enable the designer to go to the flight test phase confidently.

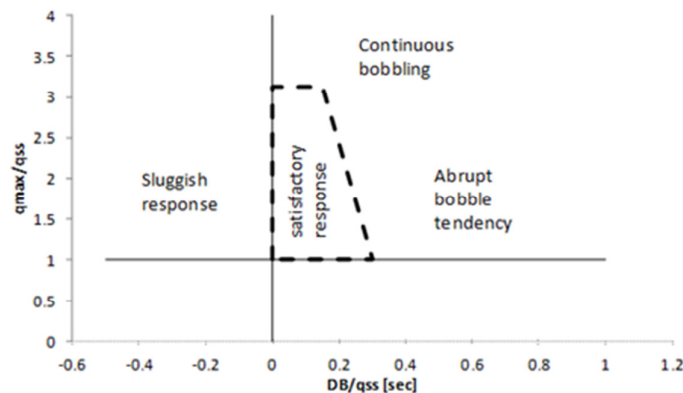

Fig. 1. The boundaries of Dropback Criteria

2. Advanced FHQ

Flying and handling qualities (FHQ) play a significant and necessary role in control system design for aircraft [5, 6]. In order to ensure the accomplishment of desired mission safely and successfully with the minimum amount of workload for the pilot, the control system needs to satisfy the corresponding specification and standards. The automatic flight control system design begins by determining the design goals from the relevant handling qualities specification. The handling qualities specifications widely applied in industry are military flying qualities specifications MIL-SPEC-8785C [7], Military Standard MIL-STD-1787B [8]. It is customary to rate handling qualities in terms of Cooper and Harper [9] levels.

2.1 Control Anticipation Parameter (CAP) Criterion

The CAP criterion was developed to predict the precision that a pilot could expect in controlling an aircraft's flight path. Nevertheless, it is required to obtain a lower order equivalent system to apply this criterion for highly augmented aircraft. Although the normal acceleration response is determined by the aerodynamic property, the CAP criterion aims to assess the transient peak magnitude of angular pitching acceleration which is mainly decided by the short period dynamics after the pitch control input. Therefore, it is significant and universally used to evaluate acceptability of the short period mode feature according to aerodynamic properties and the different operating conditions [10]. The formal definition of CAP is the amount of instantaneous angular pitching acceleration per unit of steady state normal acceleration. The value of CAP is given in terms of second order like parameters and which is currently in use.

$$CAP = \frac{\dot{q}(0)}{n_z(\infty)} = \frac{\omega_{ns}^2}{N_\alpha} = \frac{\omega_{ns}^2 \cdot g \cdot T_{02}}{U} \quad (1)$$

CAP is evaluated graphically by parameters ω_{ns} and N_α as shown in Fig.6, using reduced second order aircraft model for the step response of short period (SPO) mode.

2.2 Gibson's Dropback Criterion

The Gibson's Dropback criterion aims to design a command and stability augmentation system (CSAS) which could give an aircraft with satisfactory handing qualities. This criterion is described as limiting values with pitch rate overshoot ratio q_m/q_s versus the ratio of attitude Dropback to steady pitch rate ($\Delta\theta_{peak}/q_s$), which are shown in Fig. 2. Here, criterion mappings are related to qualitative descriptions of the response such as abruptness, sluggishness, and bobbling. Negative Dropback is an indication of sluggishness, while large positive values of Dropback indicate abrupt and bobbling tendencies [11].

3. Mathematical Equation of Aircraft Motion

3.1 Aircraft Model Description

The aircraft chosen for the research is UTM-UAV (shown in Fig.2). This UAV developed by the researchers in Universiti Teknologi Malaysia (UTM). The plane has a V-tail configuration with Ruddervator control surfaces. The aircraft uses a swept-sweptback wing and has both aileron and flap control surfaces. A summary of relevant physical parameters of the UTM-UAV is presented in Table 1.



Fig. 2. Research Aircraft: UTM UAV

Table 1

Summary of important aircraft geometry

| Parameter | Description | Value and Units |
|------------|---------------------|----------------------|
| S | wing reference area | 0.397 m ² |
| B | wing span | 1.979 m |
| C_{mean} | wing chord | 0.213 m |
| M | Aircraft mass | 5 kg |

3.2 UTM-UAV Open Loop Model

In this paper, the UTM-UAV is modelled using six degrees of freedom nonlinear model developed by Nogoud [12]. However, for design purpose, only the longitudinal motion of the aircraft is considered in this paper. Using trim and linearization routines, the aircraft equations of motion have been linearized for different flight conditions in terms of altitude, speed and center gravity position. Then, as usually done in flight control systems [13-15], the phugoid mode was eliminated and only the short period mode was considered. The actuators dynamics are modelled using second order transfer functions. The state-space representing the elevator actuator dynamics are given in equation 2. Thus, by adding the elevator actuators dynamics in equation 2 to the reduced order of aircraft longitudinal dynamic, the unaugmented reduced order model is represented by a 4th order state space model, results in the state space equation as presented in equation 3.

$$\begin{bmatrix} \dot{\eta} \\ \dot{v}_\eta \end{bmatrix} = \begin{bmatrix} 0 & 1 \\ -\omega_{ac}^2 & -2\zeta_{ac}\omega_{ac} \end{bmatrix} \begin{bmatrix} \eta \\ v_\eta \end{bmatrix} + \begin{bmatrix} 0 \\ \omega_{ac}^2 \end{bmatrix} [\eta_{act,d}] \quad (2)$$

$$\begin{bmatrix} \dot{\alpha} \\ \dot{q} \\ \dot{\eta} \\ \dot{v}_\eta \end{bmatrix} = \begin{bmatrix} z_w & \frac{z_q}{U_o} & \frac{z_\eta}{U_o} & 0 \\ m_w U_o & m_q & m_\eta & 0 \\ 0 & 0 & 0 & 1 \\ 0 & 0 & -\omega_{ac}^2 & -2\zeta_{ac}\omega_{ac} \end{bmatrix} \begin{bmatrix} \alpha \\ q \\ \eta \\ v_\eta \end{bmatrix} + \begin{bmatrix} 0 \\ 0 \\ 0 \\ \omega_{ac}^2 \end{bmatrix} [\eta_{act,d}] \quad (3)$$

3.3 Atmospheric Disturbance Model

The atmospheric disturbance model implemented is that as presented in MIL-F-8785C [16]. There are two main components to this model: a turbulence model and a discrete gust model. Two turbulence models are presented in MIL-F-8785C, the von Karman method, and the Dryden method. The Dryden form has been implemented in this instance due to ease of implementation in the time domain.

The atmospheric turbulence is modeled by Dryden's function; it is shown by Eq. (4) in its state space form [13].

$$\begin{bmatrix} \dot{w}_g \\ \dot{v} \end{bmatrix} = \begin{bmatrix} 0 & 1 \\ -\frac{1}{T_{wg}^2} & -\frac{2}{T_{wg}} \end{bmatrix} \begin{bmatrix} w_g \\ v \end{bmatrix} + \begin{bmatrix} \sigma_{wg} \sqrt{\frac{3}{\pi T_{wg}}} \\ \sigma_{wg} \sqrt{\frac{1}{\pi T_{wg}^3}} (1-2\sqrt{3}) \end{bmatrix} [N] \quad (4)$$

The filter gain and time constant (T_{wg}) were identified by:

$$T_{wg} = \frac{L_w}{U_0} \quad (5)$$

The discrete gust as defined by MIL-F-8785C [16] has the "1 – Cosine" shape given by eq. (6).

$$\begin{aligned}
 u_g, v_g, w_g &= 0 & x < 0 \\
 u_g, v_g, w_g &= \frac{v_{gm}}{2} \left(1 - \cos\left(\frac{\pi x}{d}\right) \right) & 0 \leq x < d_m \\
 u_g, v_g, w_g &= v_{gm} & x > d_m
 \end{aligned} \tag{6}$$

where u_g , v_g , and w_g are gust magnitudes, and d_m is gust lengths, this gust length is user defined so that the gust can be tuned to each of the natural frequencies of the aircraft and its flight control system.

4. Superaugmentation Flight Control System

Figure 3 shows the proposed structure of the longitudinal flight control system design. To track the pitch rate commands q_{com} , the controller architecture consists of a Stability Augmentation System (SAS) and a Command Augmentation System (CAS). The inner loop feedback or the SAS is formed of two feedback loops with gains k_α and k_q , and it is necessary to improve the aircraft stability. The gains k_α and k_q are adjustable gains and must be tuned in order to improve the aircraft stability.

The Command Augmentation System CAS is composed of an integral controller k_i , feedforward gain k_m and pre-filter $PF(s)$. The gains in CAS it is to improve the aircraft handling qualities. The command variable, as shown in Figure 3 is the pitch rate q_{com} , which after being compared with the pitch rate feedback, q , is integrated to give exactly the amount demanded. This type of command and stability augmentation system (CSAS) is called a pitch rate command/attitude hold control system.

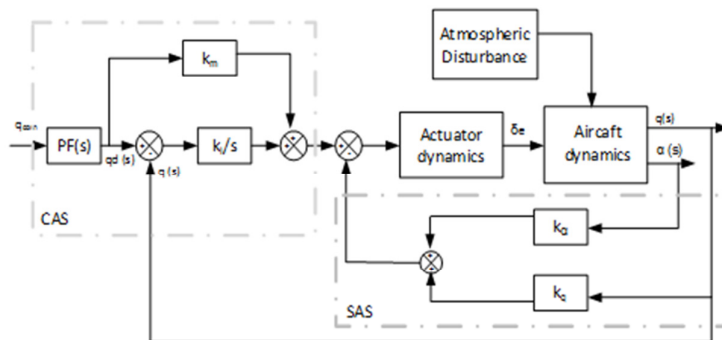

Fig. 3. Pitch rate command /attitude hold controller architecture.

3.1 Flight Control System Design Rules

The requirements used in the design of longitudinal flight control systems are those is considered boundaries of the level 1 flying and handling qualities as presented in MIL-F-8785C [16]. These are repeated here in Table 2. They are expressed in term of short term mode damping ratio, ζ , Control Anticipation Parameter, CAP, Gibson dropback criteria DB/qss.

The control architecture and the requirements used in the design being defined, the next section presents the control algorithm for automatically tuning the controller gains to achieve the desired flying and handling qualities.

Table 2
 Flying and handling qualities boundaries

| FHQs | Level 1 |
|--|---|
| Short term mode damping ratio, ζ_s | $0.5 \leq \zeta_s \leq 1.3$ |
| Control Anticipation Parameter, CAP | $0.16 \leq CAP \leq 3.6$ |
| Gibson dropback criteria, DB/qss | $\left\{ \begin{array}{l} 0 \leq \frac{DB}{q_{ss}} \leq 0.3 \\ T_{\theta 2_{desired}} = \frac{2\zeta_s}{\omega_{n_s}} \end{array} \right\}$ |

The procedures needed to find the controller gains that satisfy the requirements of flying and handling qualities and robustness for the augmented system in Fig. 3 is given as follow:

1. Select the design point (flight speed, U, Center of gravity location, CG and altitude, H).
2. Compute the state space matrices [A] and [B] for the unaugmented system as described in equation 3.
3. Choose the flying and handling qualities constraints as shown in Table 2.
4. Using the pole placement method, compute gains of controller at the selected equilibrium point.
5. Assess these local gains. If it is not satisfactory, return to step 3, else save the result and go back to step 1.

The flow diagram for the procedures of designing superaugmented flight controls system is shown in Figure 4.

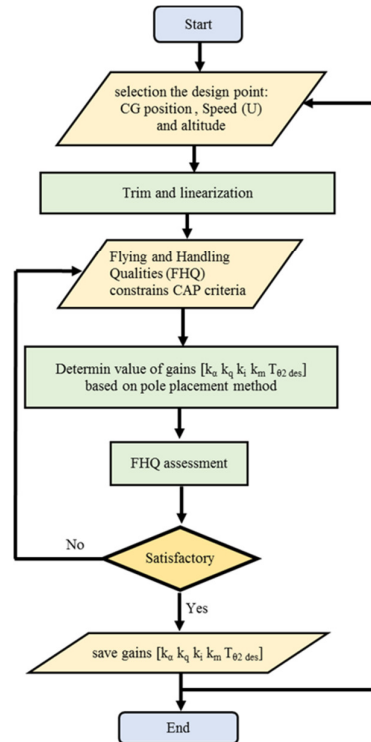

Fig. 4. Flow diagram for the procedure of designing a superaugmented flight controls system

4. Results

Before preceding this section, it is important to define the expression of augmented UAV and superaugmented UAV. In this Paper, the term of augmented UAV is referred to the UTM-UAV which are statically stable without augmentation system. While for the term of superaugmented UAV which is statically unstable without augmentation system (i.e., has a negative static margin ($kn < 0$)).

The algorithm was applied to 5 flight conditions in term of altitude, speed and centre of gravity position. These flight conditions were selected within the UTM-UAV flight envelope. The results here consistent with Mat in reference [17, 18]

Table 3 presents the flight control system gains for the structure of pitch rate command/attitude hold flight control system (PRCAH), in Figure 3. The values for different CG positions of UTM-UAV are presented.

Table 3
 Flying and handling qualities boundaries

| | K_n | $(T_{\theta 2})_{actual}$ | $(T_{\theta 2})_{desired}$ | K_{α} | K_q | K_i | K_m |
|--------------------|--------|---------------------------|----------------------------|--------------|-------|-------|-------|
| Augmented UAV | 0.27 | 0.25 | 0.43 | 5.73 | -0.55 | -3.38 | -0.18 |
| | 0.17 | 0.24 | 0.41 | 3.67 | -0.76 | -3.85 | -0.35 |
| | 0.067 | 0.23 | 0.40 | 1.60 | -0.98 | -4.31 | -0.52 |
| Superaugmented UAV | -0.033 | 0.22 | 0.38 | -0.46 | -1.20 | -4.78 | -0.69 |
| | -0.08 | 0.22 | 0.38 | -1.50 | -1.31 | -5.01 | -0.78 |

Figure 5 shows the aircraft time response for five different static margins, kn for UTM-UAV. As it can be observed, the aircraft is successfully controlled. The settling time for all the five models is less than 2 seconds and the steady state error is also less than 1%. Regarding the dropback it remains well below 0.3 as imposed by the performance in Table 2.

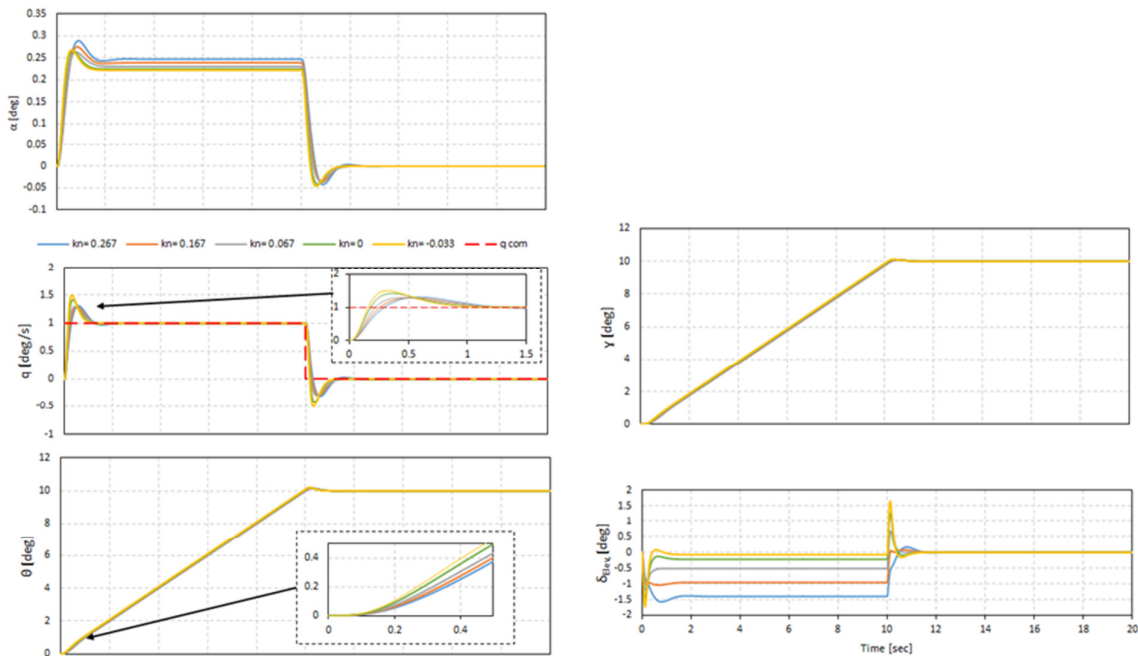

Fig. 5. Response to 1 deg/sec pitch rate command for the UTM-UAV

4.1 Flying and Handling Qualities Assessment

From Fig. 6, it is seen that for both augmented and supraaugmented UAV, and under all examined speeds the UTM-UAV configuration is inside the region of Level 1 limit given for the CAP criterion. Fig. 6 also demonstrated that as the speed increased both the CAP value and the short period damping ratio are decreased.

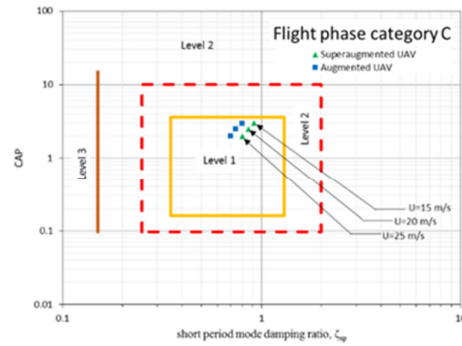

Fig. 6. CAP criterion assessment of UTM-UAV

Using the definitions of Gibson's dropback criteria, the results are presented in Figure 7. As shown in Figure 7, when using the Dropback criterion the UTM-UAV augmented, and supraaugmented configuration is assessed as Level 1 (Region of satisfactory response). This last result was expected since the requirement for zero pitch attitude dropback was used in the flight control system design. Although not exactly zero, the actual pitch attitude dropback is nevertheless minuscule.

Actually, from the flying and handling qualities assessment, it was found that speed variation has an effect on the criteria parameters. From Figure 7, it is seen that as speed increase the dropback, DB/q_{ss} decreases and the overshoot ratio, q_{max}/q_{ss} increases in a lesser degree.

Using the definitions of Gibson's dropback criteria, the results are presented in Figure 7. As shown in Figure 7, when using the Dropback criterion the UTM-UAV augmented, and supraaugmented configuration is assessed as Level 1 (Region of satisfactory response). This last result was expected since the requirement for zero pitch attitude dropback was used in the flight control system design. Although not exactly zero, the actual pitch attitude dropback is nevertheless minuscule.

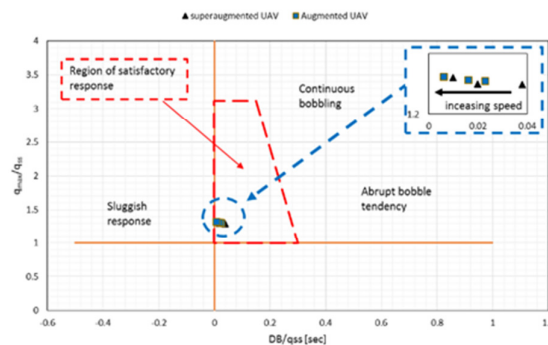

Fig. 7. Dropback criterion assessment

Actually, from the flying and handling qualities assessment, it was found that speed variation has an effect on the criteria parameters. From Fig. 7, it is seen that as speed increase the dropback, DB/qss decreases and the overshoot ratio, q_{max}/qss increases in a lesser degree.

To evaluate the gust sensitivity for the UTM-UAV with superaugmentation flight control system at different CG location (static margin), and to ensure that an ideal design value of this factor is when the CG located closed from the aircraft neutral point.

Figure 8 show the pitch rate, pitch angle and actuator activity of the two UAV vs. time as they were recorded from the simulation. The selected augmented UTM-UAV is when the CG located at ($XCG/C=0.325$) which is the current location for the existing UAV, while the superaugmented UAV refer to UAV when the CG located at ($XCG/C=0.468$).

From the results presented in Figure 8, it is apparent that the augmented UAV control system is working much harder than the superaugmented UAV to maintain the attitude, yet it has more undesired motion in pitch. A higher gain control system with faster actuators might be considered to bring the gust response of the augmented UAV down to the Superaugmented UAV level, at the expense of even more actuator activity. This may be prevented by stability limitations and unmodelled dynamics in the servo, structural modes in the airframe, and linkage flexibility between servo and elevator surfaces. Besides, the higher quality (more expensive) servo may be needed to survive the higher activity required.

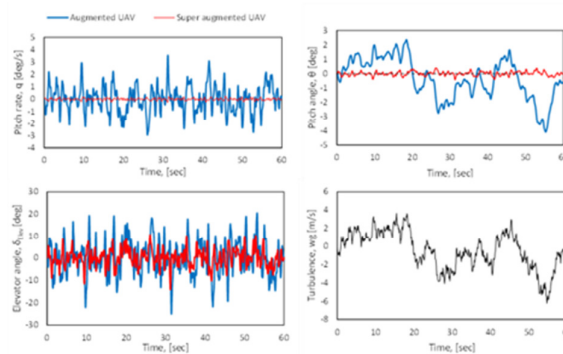

Fig. 8. Pitch rate, pitch angle and elevator activity of the two simulated UAV in severe turbulence conditions

For further comparison, a fast, significant change in the background wind direction was used to simulate a single discrete gust. The UAV is initially flying on a steady level flight, and the gust is applied from the downward. The gust was modelled as a “1- cosine” gust. The ramp up starting at 0m/s then reaching 2.14 m/s at 0.64second and remaining as shown in Fig. 9. The Pitch rate, pitch angle and elevator actuator response to this gust is provided in Fig. 9.

Both simulated UAV were able to remain flying after encountering this gust, but the responses to the gust were very different. The superaugmented UAV initially pitch away from the gust due to its positive value of $Cm\alpha$, then back again closed to zero when the gust is settled. The maximum pitch attitude for superaugmented UAV is about -0.3deg and occurs at about 0.71 seconds, while the peak pitch attitude was 1.6 deg for the augmented UAV and happened at 1.5 seconds.

In this simulation, the motion due to gust was small for each UAV because the control systems were able to remove the gust effects. In this scenario, the superaugmented UAV advantage is more clearly observed in the elevator activity (Fig 9), which clearly shows that the augmented UAV is working harder than the superaugmented UAV.

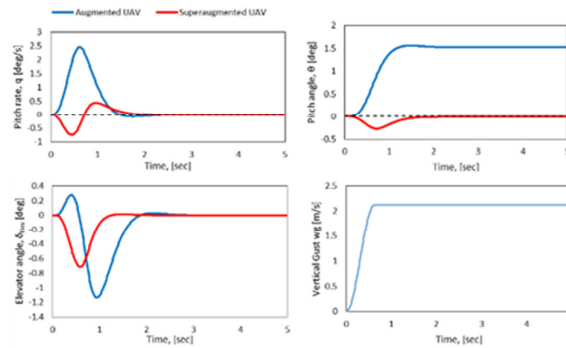

Fig. 9. Pitch rate, pitch angle and elevator activity of the two simulated UAV in severe gust conditions

4. Conclusions

This paper proposed a technique to improve the performance of small UAVs in gusty flight conditions. The technique has been developed based upon the FHQ and multivariable stability technique. The algorithm has tried to find a controller that can satisfies several performances expressed concerning handling qualities. The control system was applied to UTM-CAMAR UAV model. The results obtained here showed this control system can improve the model navigation system of the UAV.

Acknowledgement

This research was funded by a grant from Ministry of Higher Education of Malaysia and Universiti Teknologi Malaysia (FRGS Grant R.J130000.7824.4F172). Our acknowledgement also to UTM Low Speed Wind Tunnel Testing Facility. The data presented, the statement made, and views expressed are solely the responsibility of the authors.

References

- [1] Cárdenas, Elsa M., Pedro J. Boschetti, and Miguel R. Celi. "Design of control systems to hold altitude and heading in severe atmospheric disturbances for an unmanned airplane." In *50th AIAA Aerospace Sciences Meeting including the New Horizons Forum and Aerospace Exposition, Nashville, Tennessee*. 2012.
- [2] De Bruin, Andrew, and Thomas Jones. "Accurate autonomous landing of a fixed-wing unmanned aircraft under crosswind conditions." *IFAC-PapersOnLine* 49, no. 17 (2016): 170-175.
- [3] Cook, Robert G., Rafael Palacios, and Paul Goulart. "Robust gust alleviation and stabilization of very flexible aircraft." *AIAA journal* (2013).
- [4] Chao, Haiyang, Yongcan Cao, and YangQuan Chen. "Autopilots for small fixed-wing unmanned air vehicles: A survey." In *Mechatronics and Automation, 2007. ICMA 2007. International Conference on*, pp. 3144-3149. IEEE, 2007.
- [5] Field, Edmund J., Kenneth F. Rossitto, and John Hodgkinson. "Flying qualities applications of frequency responses identified from flight data." *Journal of aircraft* 41, no. 4 (2004).
- [6] Shao, Ke, Zhigang Wu, Chao Yang, Lei Chen, and Bin Lv. "Design of an adaptive gust response alleviation control system: simulations and experiments." *Journal of Aircraft* 47, no. 3 (2010): 1022.
- [7] Specification, Military. "Flying qualities of piloted airplanes." *United States Department of Defense* (1980).
- [8] Hoh, ROGER H., and David G. Mitchell. "Handling-qualities specification-a functional requirement for the flight control system." *Advances in aircraft flight control* (1996): 3-33.
- [9] Cooper, George E., and Robert P. Harper Jr. *The use of pilot rating in the evaluation of aircraft handling qualities*. No. AGARD-567. Advisory Group for aerospace research and development Neuilly-Sur-Seine (France), 1969.
- [10] Kivioja, David A. *Comparison of the Control Anticipation Parameter and the Bandwidth Criterion During the Landing Task*. No. AFIT/GAE/ENY/96M-2. AIR FORCE INST OF TECH WRIGHT-PATTERSON AFB OH, 1996.

- [11] Gibson, John Campbell. *Development of a methodology for excellence in handling qualities design for fly by wire aircraft*. Delft: Delft University Press, 1999.
- [12] Nogoud YAM. *Superaugmentation and Stability Augmentation Control System for Unmanned Aerial Vehicle*. Johor: UniversitiTeknologi Malaysia; 2017.
- [13] Cook, Michael V. *Flight dynamics principles: a linear systems approach to aircraft stability and control*. Butterworth-Heinemann, 2012.
- [14] SERIES, AIAA EDUCATION. "Gust loads on aircraft: concepts and applications." (1988).
- [15] Wright, Jan Robert, and Jonathan Edward Cooper. *Introduction to aircraft aeroelasticity and loads*. Vol. 20. John Wiley & Sons, 2008.
- [16] Moorhouse, David J., and Robert J. Woodcock. *Background information and user guide for MIL-F-8785C, military specification-flying qualities of piloted airplanes*. No. AFWAL-TR-81-3109. AIR FORCE WRIGHT AERONAUTICAL LABS WRIGHT-PATTERSON AFB OH, 1982.
- [17] Nurulhuda Tajuddin, Shabudin Mat, Mazuriah Said, Shumaimi Mansor. "Flow Characteristic of Blunt- edged Delta Wing at High Angle of Attack." *Journal of Advanced Research in Fluid Mechanics and Thermal Sciences* 39, no. 1 (2017): 17-25.
- [18] Muhammad Zaki Abdul Manaf, Shabudin Mat, Shuhaimi Mansor, Mohd Nazri Nasir, mTholudin Mat Lazim, Wan Khairuddin Wan Ali, Wan Zaidi Wan Omar, Zurriati Mohd Ali, Ainulotfi Abdul-latif, Mastura Abd Wahid, Md Nizam Dahalan, Norazila Othman. "Influences of External Store on Aerodynamic Performance of UTM-LST Generic Light Aircraft Model." *Journal of Advanced Research in Fluid Mechanics and Thermal Sciences* 39, no. 1 (2017): 36-46.