

Mechanical properties of bamboo and bamboo composites: A Review

Open
Access

Calvin Yap Thai Ming¹, Wong King Jye¹, Haris Ahmad Israr Ahmad^{1,*}

¹ Center for Composite, Faculty of Mechanical Engineering, Universiti Teknologi Malaysia, 81310 Skudai Johor, Malaysia

ARTICLE INFO

Article history:

Received 14 August 2017

Received in revised form 26 September 2017

Accepted 3 October 2017

Available online 5 October 2017

ABSTRACT

This article discusses on the studies that have been done by previous researchers on the mechanical properties of bamboo. Nowadays, natural fibre composites have gained the attentions of many industries as alternative materials due to their various advantages such as sustainable, abundant, low cost and good specific strength. With the current emphasis on environmental friendliness and sustainability, natural fibre composites are more preferred over conventional fibre which is normally non-biodegradable. Bamboo is a type of natural fibre composites that are widely used in many industries such as in construction and furnishing. Hence, it is crucial to study the mechanical properties of bamboo to make sure it is safe for certain applications. However, there are many factors that determine the mechanical properties of bamboo such as species, age and so on. This journal compiles and reviews on some of the researches on the mechanical properties of pure bamboo and bamboo composites such as their tensile properties, compressive properties, impact strength and fracture toughness. The reviews include how the researchers set up their experiments, the bamboo species used and the results obtained. Since bamboo are constantly exposed to harsh environment such as rain and river, the effect of moisture/ water content on the mechanical properties of bamboo are also reviewed and it exposed that moisture content has drastic effect on the mechanical properties of bamboo.

Keywords:

Bamboo, natural fiber, mechanical properties, eco-composite

Copyright © 2017 PENERBIT AKADEMIA BARU - All rights reserved

1. Introduction

Nowadays, many major industries, such as aeronautics, furnishing and construction, sought for composite materials due to their overwhelming advantages such as lightweight and durable. For example, aircraft manufacturers have increased the usage of composite materials in manufacturing aircraft. Around 53% of the weight of the Airbus A350 are contributed to composite materials [1]. However, one of the drawbacks of using composite materials is environmental issue. Since most conventional composites are non-renewable and non-recyclable, pollution problem has become an issue when conventional composites are used. With the current emphasis on environmental-

* Corresponding author.

E-mail address: haris@mail.fkm.utm.my (Haris Ahmad Israr Ahmad)

friendliness and sustainability, natural fibre composites have gained the attention of many industries as alternative materials. In general, natural fibre composites are made up of natural fibres that are embedded in a matrix. The advantages of natural fibre composites as reported in open literature are biodegradable, low cost, environmental friendly (low pollution) and low density which resulting in good specific strength [2-4]. According to Pickering, *et al.* [3] natural fibre composite has high potential to substitute synthetic fibre reinforced plastics at lower cost and better sustainability [3]. Natural fibres are hair-like materials that can be obtained from animal, plant and mineral sources as reported in [4]. Bamboo is a type of natural fibre composites which belongs to the plant fibre group. Bamboo is a type of stalk fibre that can be found abundantly in tropical and subtropical countries. Bamboo are used for many daily life applications such as in building bridges and as scaffolding as shown in Figure 1 [5-6].



(a) Footbridge Prototype [5]



(b) Bamboo Scaffolding [6]

Fig. 1. The common applications of bamboo

It would be devastating if bamboo fails to support the structures in these applications. This makes the studies and testing of the mechanical properties of bamboo more important. Up to now, the studies on the mechanical properties of bamboo are still lacking. Moreover, the mechanical properties of bamboo depends on its species and there are more than 1,450 bamboo species globally [7]. Hence, it is important to study and conduct tests on the bamboo species in order to determine their mechanical properties. In addition, the mechanical properties of bamboo also depend on many other factors such as site/soil and climatic condition, harvesting technique, diameter, density, age, moisture content, height, nodes or internodes and position in the culm [8]. Hence, this paper will review the studies on the mechanical properties of bamboo by numerous researchers.

2. Bamboo

Bamboo is a type natural fibre composite that is classified as stalk fibre. Bamboo is placed under the *Bambusoideae* subfamily under the Plantae kingdom. There are about 70 genera of bamboo and more than 1,450 bamboo species globally, of which 14 genera can be found in the tropical zone of Asia [8]. Bamboo is also considered as the most primitive grasses due to some of its characteristics such as the presence of bracteates, indeterminate inflorescences and flowers with three lodicules, six stamens and three stigmata [9]. The structure of a bamboo is as shown in Figure 2(a) [10]. The nodes are what divide the bamboo stems into sections called, culms or internodes. These nodes will prevent the bamboos from buckling when the bamboos are bent [11]. The culms of the bamboo are

invariably, but not always, hollow. There is a species of bamboo named *Guadua amplexifolia* that has near solid stems [12].

Bamboo consists of cellulose fibre which are aligned along the length of the bamboo. It is these cellulose fibres that give bamboo maximum tensile flexural strength and rigidity in that direction [13]. The cellulose fibre is composed of vascular bundles and bundle sheaths which functions to transport water and mineral throughout the length of bamboo. These cellulose fibres are embedded in lignin as shown in the cross-section of a bamboo culm in Figure 2(b) [14]. The cellulose fibres is the reinforcement while the lignin is the matrix which ultimately makes bamboo a natural composite.

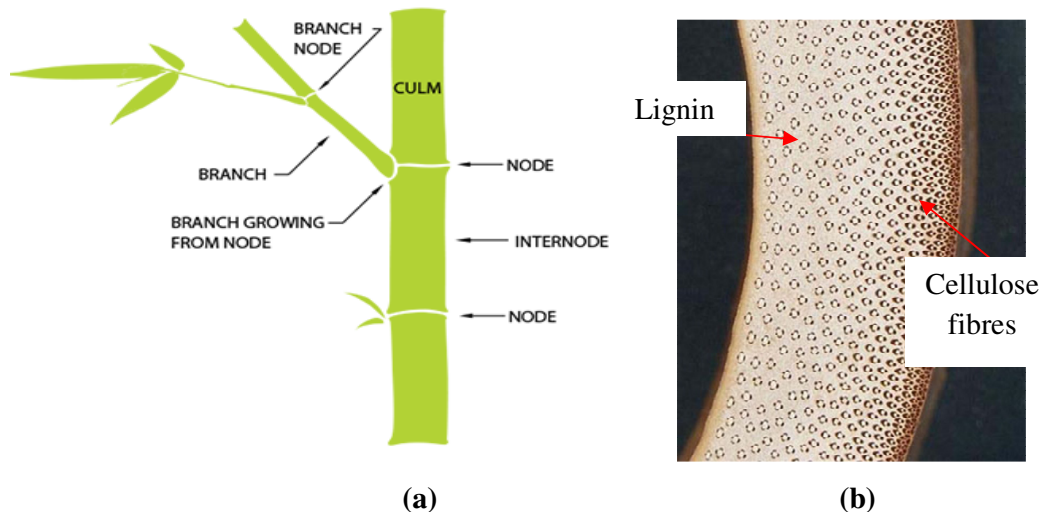

Fig. 2. (a) Structure of bamboo [10] (b) Cross-section of bamboo culm [14]

As shown in Figure 2(b), there is an uneven distribution of cellulose fibre in the cross-section of the culm [14]. The density of the cellulose fibre increases from the inner part of the culm to the outer part of the culm. This uneven distribution of cellulose fibre will affect the mechanical properties of the bamboo. In general, the cellulose fibres account for 40% of a culm by volume [15]. Unlike woody plants, there are no rays or tree rings in bamboo. This ultimately gives bamboo a far more uniformly distributed stresses throughout its length. The length of the bamboo culms depends on the species of the bamboo, ranging from 5 cm to over 60 cm per culm [16]. According to a study by Amada et al., the length of bamboo culms increases from the lower part of the bamboo to the middle part of the bamboo and then culm length decreases when it reaches the upper part of the bamboo [11]. From the same study, it is also observed that the diameter and thickness of the bamboo culm decreases as the location of the culm is further from the ground, respectively [11].

3. Mechanical Properties of Bamboo

3.1 Factors Affecting the Mechanical Properties of Bamboo

As aforementioned, the mechanical properties of bamboo depends on many factors such as species, culm position, age and so on. These factors affect the fibre density of the bamboo at specific location on the bamboo. The density of the fibre will determine the strength of the bamboo. Beside these factors, it is also noted that bamboo is an orthotropic material in natural, meaning that it has different mechanical properties in the longitudinal, radial and tangential direction of the bamboo [17]. In conclusion, the density of the cellulose fibre throughout the bamboo is not uniform. Nogata and Takahashi had successfully plotted the graph of fibre density percentage versus distance from

the inner surface of bamboo as shown in Figure 3 [18]. We can see that for both specimens, the fibre density increases as the distance from the inner surface increases. Specimen A is obtained from a lower part of the bamboo and Specimen B is obtained from the upper part of the bamboo. This study also shows that the fibre density increases from the lower part of the bamboo to the upper part. Nogata and Takahashi also determined the ultimate tensile strength and modulus of elasticity of bamboo from the inner part of bamboo to the outer part at different height of the bamboo as shown in Figure 4 [18]. The ultimate tensile strength and modulus of elasticity of bamboo increases from the inner part of the bamboo to the outer part of the bamboo. They also showed that the lower part of the bamboo is weaker than the upper part of the bamboo. The study by Nogata and Takahashi had successfully relate the strength of bamboo to the density of fibre. The strength and stiffness of bamboo is directly proportional to the fibre density.

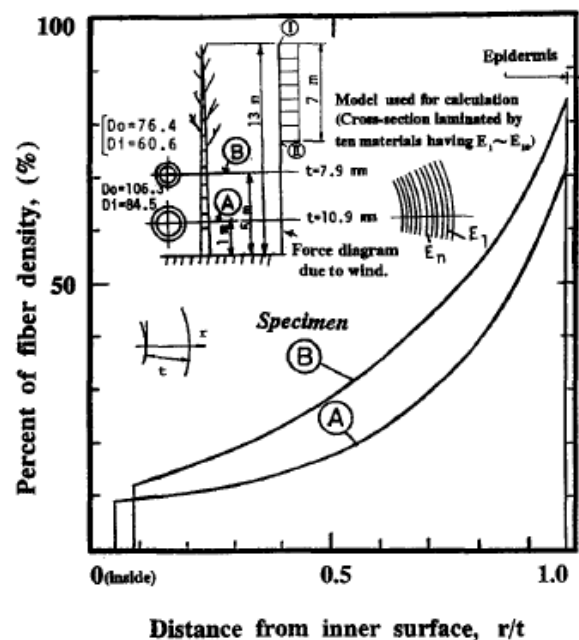

Fig. 3. Plot of fibre density percentage versus distance from inner surface of bamboo at different location [18]

Verma and Chariar also carried out similar studies and the results support the findings of Nogata and Takahashi [19]. In addition, Verma dan Chariar studied the relationship between fibre density and the ultimate compression strength as shown in Figure 5 [19]. They showed that as the distance of the bamboo culm from the ground increases, the ultimate compressive strength also gradually increase due to the increase in fibre density. This also means that the ultimate compressive strength increases from the inner part of the bamboo to the outer part.

According to the research collection by Janssen, dry bamboo has a better mechanical properties when compared to wet bamboo [20]. Besides that, bamboo with thicker wall has better mechanical properties generally. According to Janssen, different species of bamboo has different mechanical properties and bamboo has the best mechanical properties when they are aged between 3 to 7 years old [20]. Young and old bamboos have lower mechanical properties [20]. According to Amada and Untao, the optimum age occurs around 2.5 to 4 years old [14].

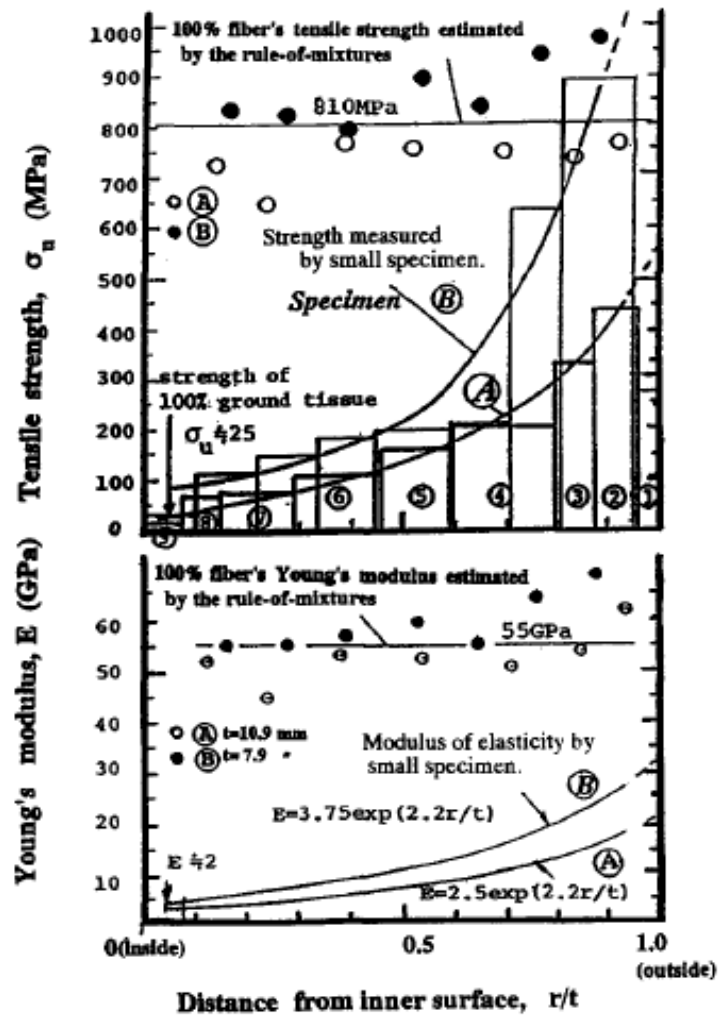

Fig. 4. Plot of tensile strength and Young's modulus versus distance from inner surface of bamboo at different location [18]

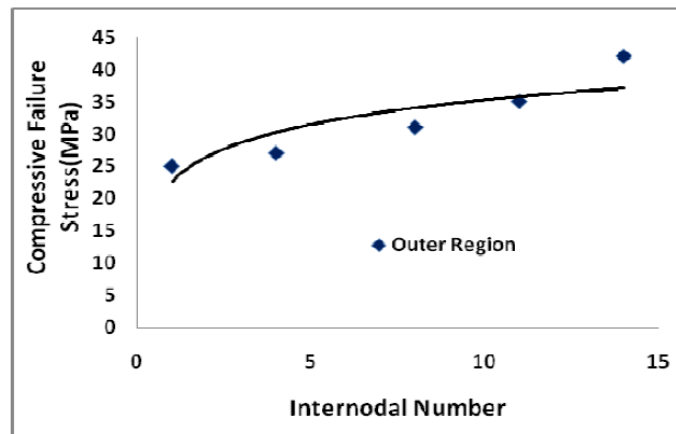

Fig. 5. Plot of ultimate compressive strength versus distance of bamboo culm from ground [19]

3.2 Tensile Properties of Bamboo

Numerous tests and studies had been done by researchers on the mechanical properties of bamboo, especially on their tensile and compression properties. For example, the tensile properties of several bamboo species have been studied by several researchers such as moso bamboo [16], *Dendrocalamus strictus* [19] and so on. However, the results obtained might differ from one study to another as different approaches are used. The species of the bamboo, specimen size and shape, presence of node and the condition of the bamboo used are different.

Lakkad and Pattel conducted an experiment to determine the mechanical properties of bamboo [13]. The species of the bamboo used is unknown but it is mentioned that dry bamboo was used. The dimension used is 6 mm (T) x 12 mm (W) x 200 mm (L). No nodes are present in the specimens. From the experiment, the ultimate tensile strength and ultimate compressive strength of bamboo is 193 MPa and 68.4 MPa, respectively. In term of specific strength, the specific tensile strength of bamboo is 214.4 km²/s², which is 4 times greater to the specific tensile strength of mild steel which is 50.6 km²/s². From this experiment also, it is found that the specific modulus of elasticity of bamboo is comparable to unidirectional glass reinforced plastic (GRP) but lower than the specific modulus of elastic of mild steel as shown in Table 1 [13]. The specific properties give an insight into comparative strength and stiffness on a weight basis, particularly under unidirectional loads [13].

Table 1
 Tensile and compression test results by Lakkad and Pattel [13]

Material	Specific modulus (km ² /s ²)	Specific tensile strength (km ² /s ²)	Specific compressive strength (km ² /s ²)
Mild steel	25316	50.6	-
Polymer resin	3636	36.4	90.9
GRP with WR and CSM	4965	103.4	89.1
Unidirectional GRP	22944	250	166.7
Bamboo	22889	214.4	75.96

Sakaray, *et al.* [16] has conducted tensile test and compression test on moso bamboo [16]. The tensile and compression specimens have nodes in them. For the compression test, the specimens are in cylindrical shape. From the test, it is found that the ultimate tensile test of moso bamboo is around 115 – 128 MPa and the modulus of elasticity is around 15 GPa. The average ultimate compression test obtained by them is 108.19 MPa. It is quite notable that the mechanical properties are decreased when nodes are present. The nodes might have affected the mechanical properties of bamboo. In fact, the tensile tests by Verma and Chariar had proved the above hypothesis [19]. From Figure 6 [19], it can be seen that intermodal specimen (no nodes in between specimen) has higher ultimate tensile stress when compared to the nodal specimen. However, the ultimate tensile strength for the intermodal specimen obtain by them is relatively higher, at around 280 MPa. The ultimate compressive stress of the intermodal specimens obtained by them is around 43 MPa [19]. Verma and Chariar used four year old green bamboo (*Dendrocalamus strictus species*) and the dimension used for the tensile and compression specimens are 200 mm (L) x 15 mm (W) x 1.5 mm (T) and 120 mm (L) x 16 mm (W) x 1 mm (T), respectively [19]. Tabs are used for the tensile specimens as shown in Figure 7 [19].

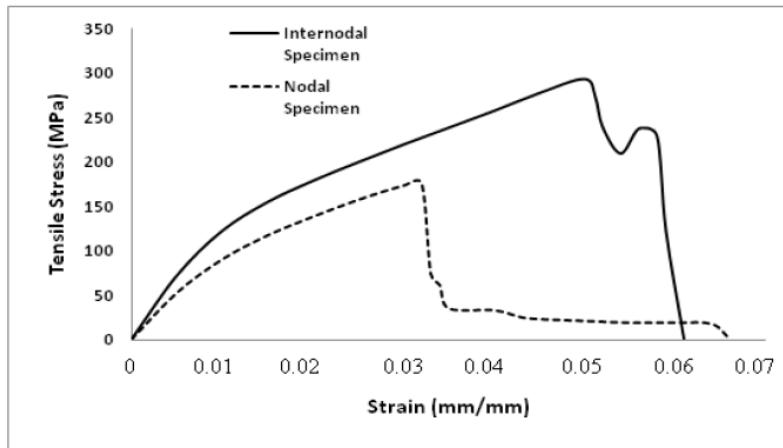

Fig. 6. Tensile test results for nodal and internodal specimens by Verma and Chariar [19]

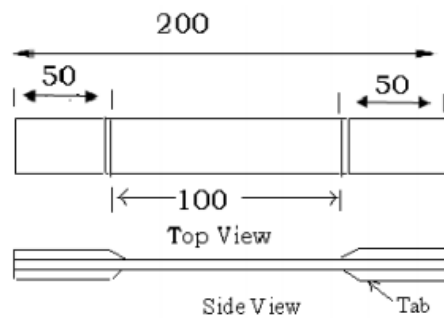

Fig. 7. Tensile specimens with tabs by Verma and Chariar [19]

Hojo, *et al.* [21] have conducted studies on the tensile properties of bamboo mat-reinforced composite [21]. The reasons behind choosing bamboo fiber mats over natural bamboo fibers are simpler manufacturing process, lower cost and the short length of original natural fibers. The bamboo fiber mat used has a bamboo fiber's density of 1.293 g/cm^3 and unit area weight of 907 g/m^2 . The bamboo fiber mat is mixed with unsaturated polyester resin to fabricate the specimens. The dimension of the material is very similar to Verma and Chariar [19] only the dimension of width is different as shown in Figure 8 [21]. Besides bamboo, Hojo, *et al.* [21] also fabricated jute and kenaf mat-reinforced composite specimens to compare their tensile properties.

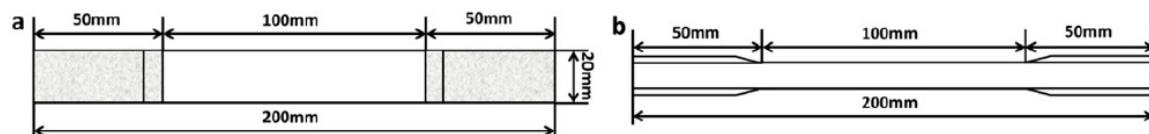

Fig. 8. Tensile specimens with tabs by Hojo, *et al.* [21]

Table 2 [21] shows the tensile test results conducted by Hojo, *et al.* [21] We can see that bamboo/UP and Jute/UP have similar tensile properties while the tensile properties of Kenaf/UP is much higher.

Table 2

Tensile test results of mat-reinforced composite by Hojo, *et al.* [21]

Mat/UP Composites	Tensile modulus (GPa)	Tensile strength (GPa)
Bamboo/UP	25316	50.6
Jute/UP	3636	36.4
Kenaf/UP	4965	103.4

3.3 Compressive Properties of Bamboo

Compressive properties of bamboo of different species have also been studied by researchers. For example, the compressive properties of several bamboo species that have been previously carried out by researchers are Kao Jue (*Bambusa pervariabilis*) [22], Mao Jue (*Phyllostachys pubescens*) [22-24], *Bambusa balcooa*, *Bambusa bambos*, *Bambusa nutans*, *Bambusa tulda*, *Dendrocalamus giganteus*, *Dendrocalamus strictus*, *Melocanna bambusoides* [25] and Hawaiian Gold Timber (*Bambusa vulgaris vittata*) [26]. Chung and Yu carried out compression tests on two bamboo species, which are *Bambusa pervariabilis* and *Phyllostachya pubescens* [22]. Bamboo culms were used as the specimens. For *Bambusa pervariabilis*, the average ultimate compressive strength obtained is 103 MPa while the average compressive modulus of elasticity obtained is 10.3 GPa [22]. For *Phyllostachya pubescens*, the average ultimate compressive strength obtained is 134 MPa while the average compressive modulus of elasticity obtained is 9.4 GPa [22]. Chung and Yu had shown that the mechanical properties of the bamboo were superior to common structural timber [22]. On the other hand, Li also conducted compression test on bamboo [23]. However, the species of the bamboo used is unknown. Li used bamboo specimens that are of different age and that are obtained from different locations of the stalk. The results obtained by Li is as shown in Table 2 [23].

Table 3

Compression test results by Li [23]

Year	Height	SG	Longitudinal	
			f_c (MPa)	E_c (MPa)
One	Bottom	0.49	47.0 (2.4)	2067 (339)
	Middle	0.53	50.9 (3.1)	2776 (362)
	Top	0.54	55.7 (3.8)	3658 (464)
Three	Bottom	0.70	86.8 (1.8)	4426 (491)
	Middle	0.71	83.9 (2.8)	4428 (305)
	Top	0.72	84.0 (3.3)	4660 (451)
Five	Bottom	0.75	93.6 (3.6)	4896 (116)
	Middle	0.78	86.6 (3.5)	4980 (262)
	Top	0.76	85.8 (5.3)	5185 (330)

Naik [27] claims that the tensile and compressive strength of raw bamboo is around 111-219 MPa and 53-100 MPa, respectively. Similar range of compressive strength (124 MPa) was found by Yap, *et al.* on the raw bamboo of *Bambusa vulgaris vittata* type [25]. Mahzuz, *et al.* stated that the mechanical properties of bamboo is superior to many timber products which are advantageous, but it is quite lower than the tensile strength of steel [28]. However, Amada and Untao claimed a different finding when compared to other studies. They claim that the tensile strength of bamboo is almost equivalent to steel [15].

3.4 Impact Strength of Bamboo

The impact strength of different species of bamboo have also been studied using different methods. There are two main types of impact tests, namely: Charpy impact test and Izod impact test. In both tests, the specimen is struck with a controlled weight pendulum at a set velocity [29]. The differences between the two are as summarized in Table 4 [30]. Some of the bamboo species that have been studied are *Gigantochloa scortechinii* [31], *Dendrocalamus strictus* [32] and *Bambusa vulgaris vittata* [33-34- haris].

Table 4
 Difference between Izod and Charpy impact test [30]

Type of Test	Izod Impact Test	Charpy Impact Test
Specimen Position	Vertical	Horizontal
Point of Strike	Upper tip of specimen	Point of notch but in opposite direction
Direction of Notch	Facing the striker that is fastened to the pendulum	Away from striker
Type of Notch	V-notch	V-notch and U-notch
Type of Hammer	Farming hammer	Ball pin hammer

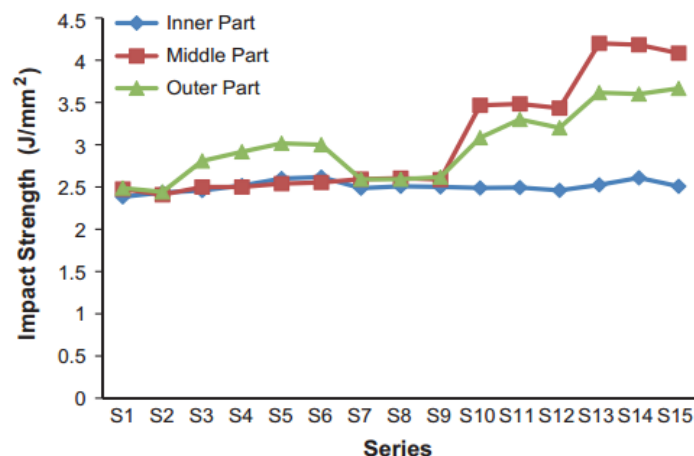

Fig. 9. Impact test results by Rassiah, *et al.* [31]

Rassiah, *et al.* [31] have conducted the Charpy impact test on pure and laminated bamboo strips. The bamboo species used is the *Gigantochloa scortechinii* [31]. The bamboo plant was cut into strip fiber parts using a cleaver and a hand saw. Then strips were cut into thicknesses of 1.5 mm, 2.0 mm, and 2.5 mm. Three region of the bamboo plants are cut, which are inner section, middle section and outer section. The bamboo strips were then subjected to the hand lay-up process. The laminated bamboo samples are fabricated by mixing unsaturated polyester with methyl ethyl ketone peroxide catalyst and then brushing this mixture on the bamboo strips. The Charpy impact test was carried out in accordance of ASTM D6110 standard [31]. The results obtained is as shown in Figure 9 [31] and Table 5 [31].

Table 5
 Impact test results by Rassiah, *et al.* [31]
 Charpy impact data for the inner, middle and outer part of the bamboo strip.

Bamboo composition		Inner layer	Middle layer	Outer layer
		Charpy impact	Charpy impact	Charpy impact
Thickness (mm)	Series	CI (J/mm ²)	CI (J/mm ²)	CI (J/mm ²)
1.5	S1 pure	2.383	2.475	2.486
1.5	S2 pure	2.435	2.408	2.442
2.0	S3 pure	2.458	2.500	2.808
2.0	S4 pure	2.517	2.500	2.917
2.5	S5 pure	2.600	2.54	3.017
2.5	S6 pure	2.617	2.553	3.000
1.5	S7	2.486	2.593	2.592
1.5	S8	2.508	2.604	2.592
1.5	S9	2.502	2.588	2.617
2.0	S10	2.488	3.467	3.083
2.0	S11	2.493	3.483	3.300
2.0	S12	2.460	3.433	3.200
2.5	S13	2.525	4.200	3.617
2.5	S14	2.608	4.183	3.600
2.5	S15	2.508	4.083	3.667

As shown in Table 5 [31], the impact strength of the bamboo specimens depends on the thickness of the bamboo fibre and the position of the bamboo. For pure bamboo specimens (S1 – S6), the outer layer specimens show a greater impact strength than the other two regions and the thicker the bamboo fibre, the greater its impact strength. For the laminated bamboo specimens (S7 – S15), bamboo specimens from the middle region show a greater ability to absorb energy than the inner and the outer part [31]. The highest energy absorbed in this study is by specimen of the middle part of series S13 at 4.2 J/ mm². This is because the middle is good in absorbing and dissipating energy under shock [31].

Jindal has conducted impact test on bamboo species of *Dendrocalamus strictus* through Izod impact test [32]. The specimens prepared by Jindal are actually not pure bamboo but bamboo fibre reinforced plastics (BFRP). The bamboo is cut into small strips rolling mill and razor to get breadth and thickness varying from 0.1 to 0.6 mm and length of 220 mm to 270 mm. The bamboo strips are then mixed with Araldite resin (CIBA-CY 230) in a mold to obtain the BFRP. The fibre volume fraction is 0.8 [32]. Notched and un-notched specimens were fabricated. For the notched specimens, 2 mm V-notch is fabricated. The dimension of the BFRP specimens is as shown in Figure 10 [32]. From his result, he obtained results that showed notched and un-notched specimens show no big difference in impact strength. Generally, the impact strength of the BFRP he produced is very low at 0.1356 Nm/ mm².

Li, *et al.* [24] worked on reformed bamboo to determine their impact strength [35]. Reformed bamboo can be prepared by boiling bamboo slices until they are soft, then press the cooked bamboo slices into a flat plate using a hot-press procedure [35]. Reformed bamboos are said to have better mechanical properties when compared to natural bamboo as shown in Table 6 [35].

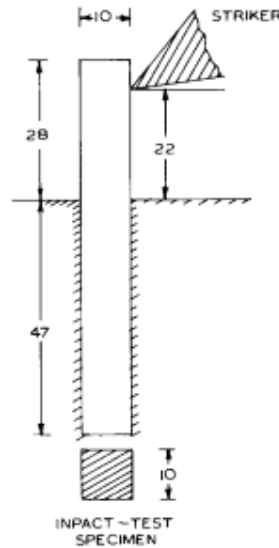

Fig. 10. Dimension of impact test specimen by Jindal [32]

Table 6

Comparison between natural bamboo and reformed bamboo [35]

Properties	Natural bamboo	Reformed bamboo
Fiber volume fraction	29.2%	43.6%
Shrinkage coefficient (bulk)	0.663	0.446
Density	0.66 g/cm ³	0.87 g/cm ³
Tensile strength	206.2 MPa	271.5 MPa
Tensile modulus	20.1 GPa	29 GPa
Flexural strength	210.3 MPa	276.6 MPa
Flexural modulus	13.1 GPa	23.2 GPa
Compressive strength	78.7 MPa	104.7 MPa

Table 7

Impact test result at impact velocity 2.1 m/s by Li, *et al.* [35]

Laminate type	Maximum load (kN)	Impact energy (J)	Maximum deflection (mm)	Normalized residual stress
BB	11	29.32	4.4	0.73
FB	8.5	29.19	4.5	0.70
BF	8.9	28.97	4.4	0.62

Note: BB represents double-layer reformed bamboo (cross-ply) laminate; FB represents FRC plate-reformed bamboo laminate (FRC plate on top); BF represents FRC plate-reformed bamboo laminate (reformed bamboo on top).

The reformed bamboo is then used to fabricate two kinds of laminate, namely double layer reformed bamboo (cross-ply) laminate and FRC plate-reformed bamboo (unidirectional) laminate, using thermoplastic ethylene-acrylic acid as adhesive. FRC stands for fiber reinforced cementitious.

The specimen size is 105 mm x 105 mm. In this experiment, a different test is used instead of Izod and Charpy impact test. A 12 kg impactor is allowed to fall freely to impinge on the center of the laminate specimen. Table 7 to Table 9 shows the impact strength of the specimens at impact velocity of 2.1 m/s, 2.6 m/s and 3.1 m/s, respectively [35]. From the result, he concluded that FRC plate-reformed bamboo laminate that has FRC plate on top can sustains the largest deflection and absorbs more energy at the same impact velocity.

Table 8
 Impact test result at impact velocity 2.6 m/s by Li, *et al.* [35]

Laminate type	Maximum load (kN)	Impact energy (J)	Maximum deflection (mm)	Normalized residual stress
BB	12.7	43.05	4.9	0.76
FB	9.1	43.09	6.0	0.68
BF	10.0	43.08	5.6	0.66

Table 9
 Impact test result at impact velocity 3.1 m/s by Li, *et al.* [35]

Laminate type	Maximum load (kN)	Impact energy (J)	Maximum deflection (mm)	Normalized residual stress
BB	14.5	63.56	6.1	0.69
FB	9.2	63.82	9.8	0.63
BF	10.8	63.67	7.8	0.60

3.5 Fracture Toughness

Fracture toughness is a property that indicates the amount of stress required to propagate a crack or flaw [36-37]. It describes how far a material can go to resist fracture at the crack. As bamboo is used in many high load structures and are exposed to wear and tear, it is essential to know its fracture properties to take the necessary precautions. Mode I and Mode II fracture properties of bamboo will be discussed here.

3.5.1 Mode I fracture properties

In Mode I fracture, the crack plane is normal to the direction of the largest tensile loading [36-37]. In Mode I fracture toughness, the mechanical property that will be studied is fracture toughness, K_{Ic} .

Liou, *et al.* [37] had carried out Mode I fracture test on bamboo culms of Moso bamboo (*Phyllostachys pubescens*) [37]. This study has used ASTM E399 test method, which involved arc-shape bend specimens. A 10 mm wide ring is sculpted out from the bamboo culms to obtain the arched shape bend specimens as shown in Figure 11(a) [37]. Force is applied directly above the crack as indicated by the red arrow in Figure 11(a) [37]. From the force versus displacement graph, an average fracture toughness of 31.2 MPa \sqrt{m} is obtained for the Moso bamboo specimens.

Amada and Untao did a throughout study on the fracture properties of 2-years old Mousou bamboo (*Phyllostachys edulis*) [38]. First of all, they have conducted Mode I fracture test on

specimens from different culm. Specimens are fabricated from culm number ($n= 5$ (nearest to root), 15 and 31 (furthest from root)) into a dog bone shape with crack as shown in Figure 11(b) [38]. Figure 12 [38] shows how the fracture toughness of bamboo varies across its thickness at various culm number.

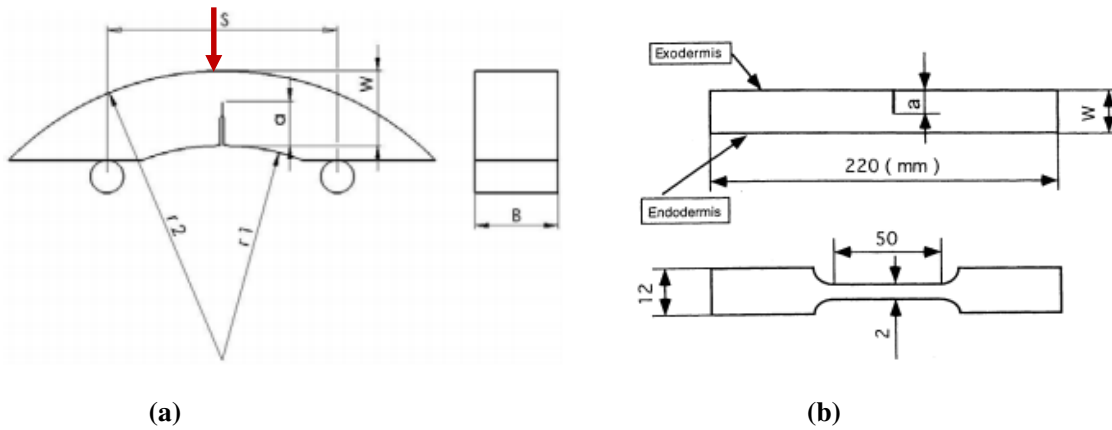

Fig. 11. (a) Arched shape bend specimens [37] (b) Mode I fracture test specimens by Amada and Untao [38]

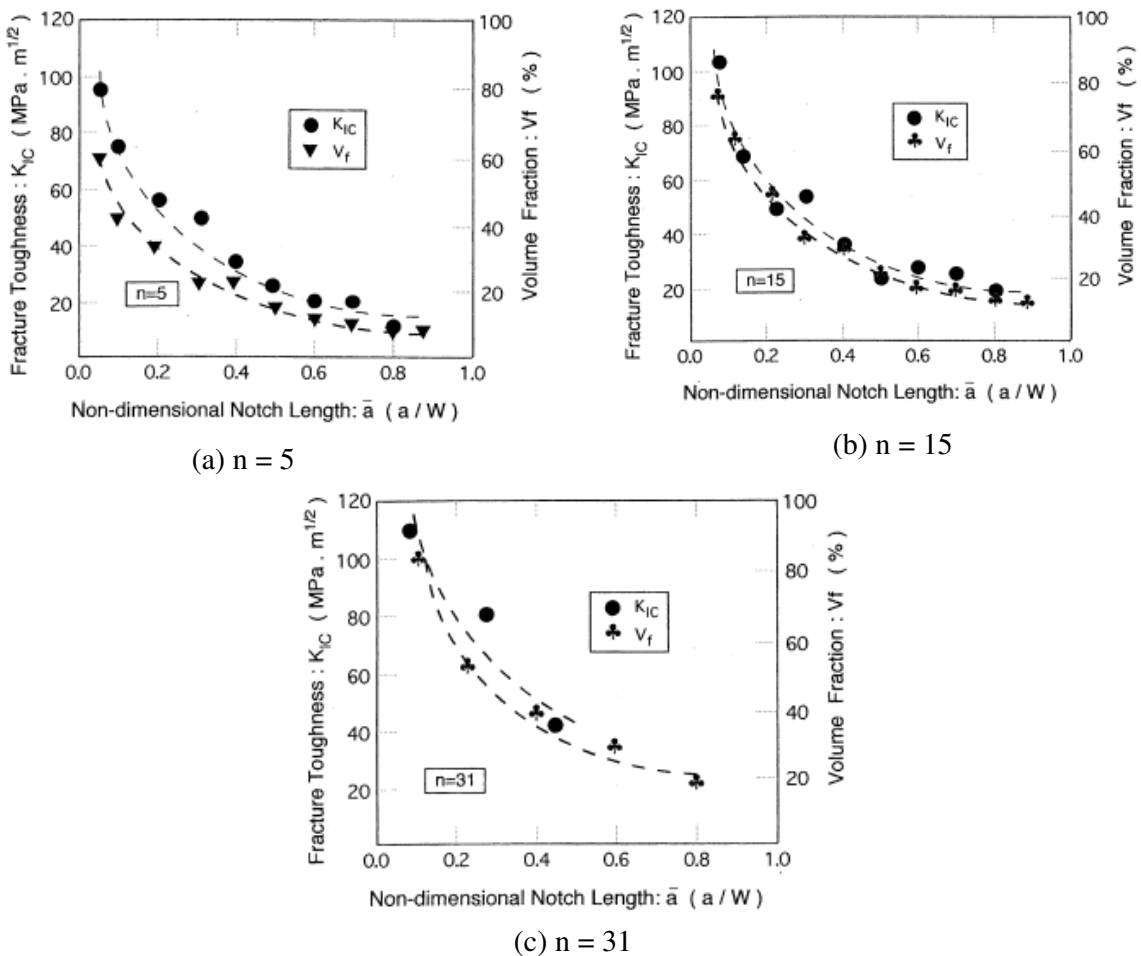

Fig. 12. Fracture toughness across bamboo thickness at various height by Amada and Untao [38]

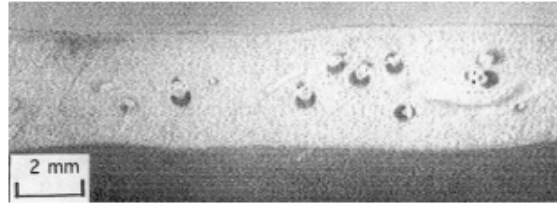

Fig. 13. Cross-section of bamboo node [38]

From the result, we can see that the outermost part of the bamboo has the highest fracture toughness and the fracture toughness decreases towards the inner surface. This corresponds to the fact that the number of fibre is the highest at the outermost region of the bamboo and decreases towards the inner surface. This is advantageous since the outer region of the bamboo is where external force is subjected and fracture is likely to occur [38]. Besides that, we can also see that the fracture toughness of bamboo increases with its height. On the other hand, Amada and Untao also conducted Mode I fracture test on the bamboo nodes. The cross-section of the node is as shown in Figure 13 [38]. As shown in Figure 13, there is only small distribution of fibre that weakly reinforce the node and are randomly orientated [38]. Amada and Untao suggested that these fibre made little or no contribution to the fracture properties of the node [38]. The average fracture toughness obtained for the bamboo node is $18.4 \text{ MPa } \sqrt{m}$, which is significantly lower when compared to the bamboo culms. Amanda and Untao have also concluded that the fracture toughness of the bamboo node is contributed by the parenchyma cells [38].

3.5.2 Mode II fracture properties

Mode II fracture properties involve in-plane shear loading, which is the sliding of one crack face with respect to the other in its on plane [37]. Wang, *et al.* [39] studied Mode II interlaminar fracture toughness of Moso bamboo (*Phyllostachys pubescens*) through the End Notched Flexure (ENF) specimens as shown in Figure 14 [39]. This setup will produce in-plane shear at the crack. Wang, *et al.* [39] used three different data processing methods to obtain the fracture toughness of Moso bamboo, namely experiment parameters substitution method (test), Timoshenko beam theory method (Timo) and compliance calibration method (comp).

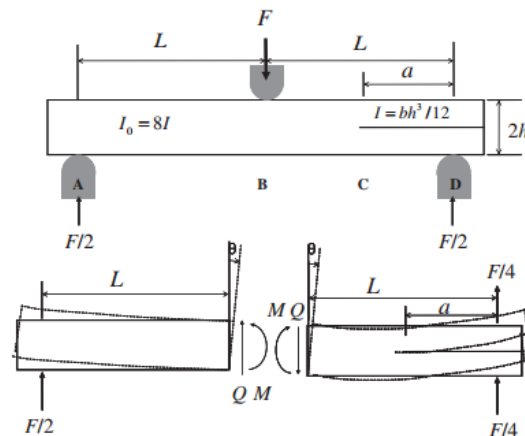

Fig. 14. ENF specimen and sketch of mechanics analysis [39]

The total number of samples used in their study is 43 samples and the average Mode II fracture toughness obtained is 1303.18 J/m², 1107.54 J/m² and 1216.06 J/m², respectively with some deviations between methods. For all three methods, the bamboo height has minimal effect on the fracture toughness of the bamboo. Wang, *et al.* claimed that the Mode II interlaminar fracture toughness can be regarded as constant [39]. They also claimed that the experiment parameters substitution method is more accurate as it clearly shows that the Mode II interlaminar fracture toughness of bamboo is constant regardless of its height.

3.6 Effect of Moisture on the Mechanical Properties of Bamboo

Since bamboo is constantly exposed to harsh environment, such as exposure to rain and river, the effect of moisture or water content on its mechanical properties has to be properly studied. Numerous researchers have conducted test to determine the effect of moisture on the mechanical properties and all have proven that the mechanical properties of bamboo is weakened by the presence of moisture.

3.6.1 Tensile and compression properties

Lakkad and Godbole have conducted an experiment that revolves around the effect of water absorption on the mechanical properties of bamboo [40]. Three types of specimen configurations are prepared: dry; soaking in distilled water for 144 hours (“wet” specimens); soaking in boiling water for 2 hours (“boiled” specimens). For the “wet” and “boiled” bamboo specimens, their weight gain are recorded from time to time to monitor water saturation level. Table 10 [40] shows the results obtained from the tests.

The tensile modulus of elasticity of the specimens is dropped by 47.7% and 31.1% when soaked in distilled water for 144h and boiled in distilled water for 2 hours, respectively. On the other hand, the tensile strength of the specimens is dropped by 36.9% and 26.6% when soaked in distilled water for 144h and boiled in distilled water for 2 hours, respectively. It shows that exposing bamboo to water has drastic effects on its tensile properties. Soaking the bamboo in distilled water for long term does more damage to its mechanical properties than boiling it in distilled water in a short period of time. Godbole and Lakkad claimed that the tensile properties of the bamboo specimens depend on the bamboo fibres only [40]. The bamboo fibres are not damaged by the high temperature. However, the diffusion of water into the “wet” and “boiled” bamboo specimens do reduce its tensile properties. As more water has been absorbed by the “wet” bamboo specimens when compared to the “boiled” bamboo specimens, their tensile properties are much reduced. In terms of compressive properties, the reduction in compressive strength is more or less the same for the “wet” and “boiled” specimens. The reduction in compressive strength is around 50%. It is very evident that water content in bamboo can greatly decrease their tensile and compression properties. Similar study has also been conducted by Yap, *et al.* on *Bambusa vulgaris vittata* type bamboo and practically the same decrement of the mechanical properties is found [26].

Thwe and Liao studied the effect of environmental aging on the tensile properties of bamboo-glass fiber reinforced polymer matrix hybrid composites [41]. They use short bamboo fibres to prepare six different bamboo fiber reinforced polypropylene (BFRP) and bamboo-glass reinforced polypropylene (BGRP) as shown in Table 11 [41]. The length of the glass fiber is 3 mm and the length of the bamboo fiber is 1- 6 mm, which both are randomly oriented in the resultant composite plate [41]. Dog-bone shaped specimens with dimensions of 60 mm x 12 mm x 3 mm were produced and the tensile tests are carried out in accordance of ASTM standard D639. To test the effect of water

absorption of bamboo on its mechanical properties, some specimens were immersed in water at 25 °C for 520 hours and 1200 hours. The result obtained is as shown in Figure 14 [41]. Table 12 [41] summarizes the reduction of tensile strength of bamboo after soaking for 520 hours and 1200 hours.

Table 10

Results of effect of moisture on the mechanical properties of bamboo by Lakkad and Godbole [40]

Type of conditioning	Tensile modulus (Nmm ⁻²)	Tensile strength (Nmm ⁻²)	Compressive strength (Nmm ⁻²)	Interlaminar shear (Nmm ⁻²)	Weight gain (%)
1. Unconditioned (dry)	22500	238.2	63.2	9.99	-
2. Soaked in distilled water for 144 h	11760	150.2	34.3	6.98	81.2
3. Boiled in distilled water for 2 h	15500	174.9	35.8	6.36	38.2
4. Epoxy coated-soaked for 144 in distilled water	21500	200.8	54.8	9.3	7.5

Table 11

Specimens prepared by Thwe and Liao [41]

Sample ID	Glass fiber content % by mass	Bamboo fiber content % by mass	Matrix type
BFRP (B)	0	30	PP
BGRP (H1)	10	20	PP
BGRP (H2)	20	10	PP
BFRP (BM)	0	30	PP/MAPP
BGRP (HM1)	10	20	PP/MAPP
BGRO (HM2)	20	10	PP/MAPP

Table 12

Reduction of tensile strength after by 520h and 1200h immersion by Thwe and Liao [41]

Sample	% Degradation in tensile strength at room temperature	
	520 h	1200 h
B	7.92	13.95
H1	5.89	9.11
H2	4.5	7.47
BM	6.84	11.55
HM1	5.62	8.9
HM2	3.54	6.84

Figure 15 [41] and Table 12 [41] show that the tensile properties of the BFRP and BGRP are reduced after being immersed in water. The longer the immersion time, the greater the reduction in the tensile properties of bamboo. Figure 16 (a) and Figure 16 (b) [41] show the SEM image of the fracture surface of the specimens after being immersed for 520h and 1200h, respectively. After being immersed for 520h, we can observe a rougher and porous bamboo fiber surface due to moisture attack [41]. After 1200 hours, the immersed specimens have a rougher surface and splitting of fibril is seen, which explains the greater reduction in tensile properties [41]. Besides that, the increased moisture levels also reduce the modulus of polymers through a plasticizing process [42].

3.6.2 Mode I fracture toughness

Liou, *et al.* [37] had also studied the effect of moisture content on the Mode I fracture toughness of bamboo [37]. The test setup by Liou, *et al.* [37] has been elaborated in 3.5.1. It is not mentioned

how long have the wet bamboo specimens been immersed in water but their fracture toughness has been reduced by 39% when compared to dry bamboo specimens as shown in Figure 17 [37]. The fracture toughness of the dry bamboo specimen is $31.2 \text{ MPa} \sqrt{m}$ while it is only $19.1 \text{ MPa} \sqrt{m}$ for the wet bamboo specimens.

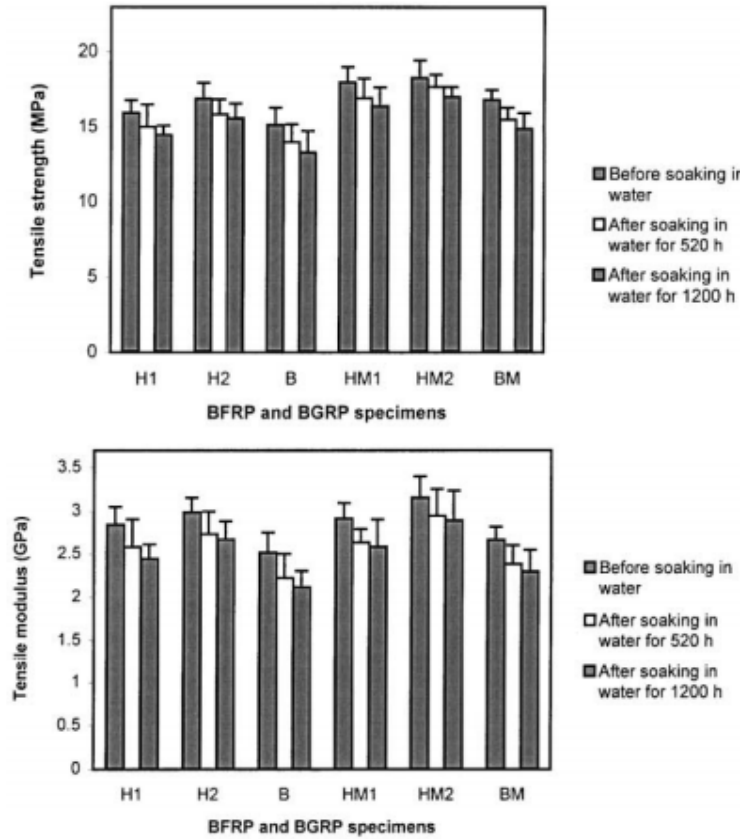

Fig. 15. Tensile strength and tensile modulus result by Thwe and Liao. [41]

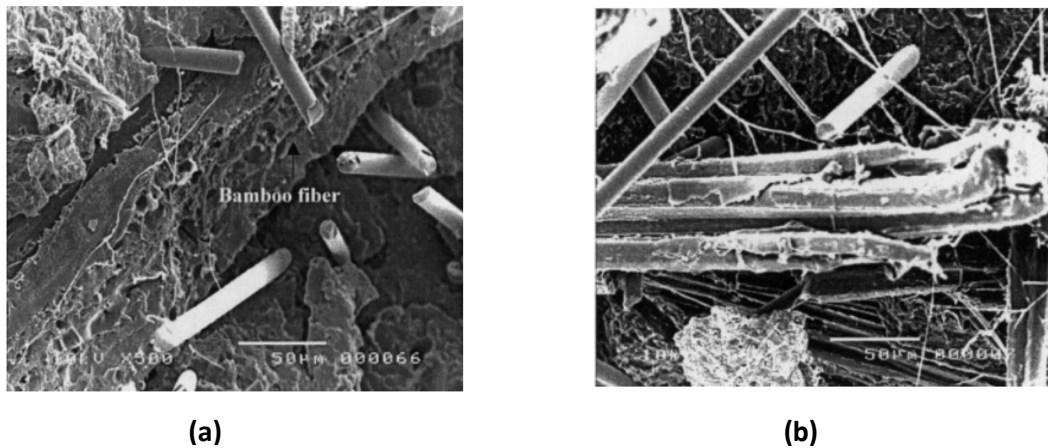

Fig. 16. (a) SEM of fracture surface after 520h water immersion [41] (b) SEM of fracture surface after 1200h water immersion [41]

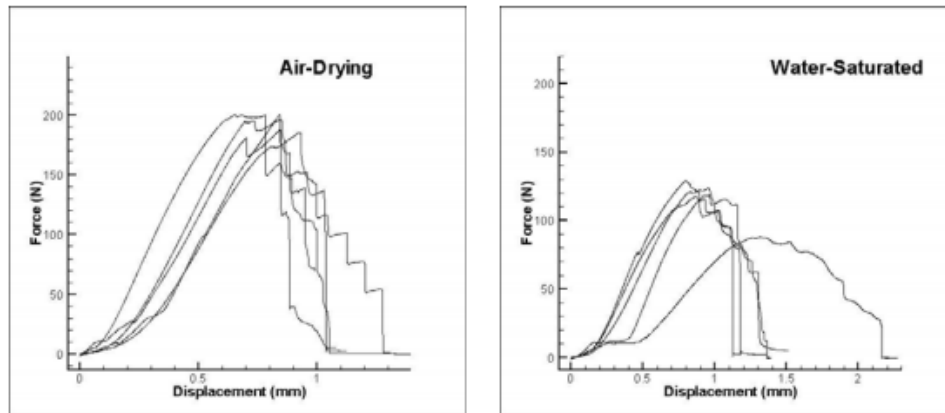

Fig. 17. Mode I fracture test result for dry and wet bamboo specimens by Liou, *et al.* [37]

4. Conclusion

This article is a compilation and review on the mechanical properties of bamboo from the researches and studies done by previous researchers. As aforementioned, the mechanical properties of bamboo depends on many factors such as species, age, soil, height and so on. It is near impossible to study the mechanical properties of all the bamboo species but some of the notable studies have been discussed in this journal. However, different approaches and standards have been used by previous researchers in their studies, making it hard to compare one research to the other. However, the results obtained by them give us a clear idea what are the mechanical properties of certain bamboo species.

The mechanical properties that have been discussed here are tensile properties, compressive properties, impact strength and fracture toughness. These are some of the mechanical properties that are crucial when using bamboo in real-life applications. In addition, the effects of moisture content on the mechanical properties have also been discussed in this journal. Since bamboo are usually used in outdoor application, it will be consistently exposed to harsh condition, such as rain and water. From the studies by previous researchers, it is shown that moisture content has drastic effect on the mechanical properties of bamboo. The tensile strength, compression strength and fracture toughness of bamboo are all reduced when exposed to water. These are crucial findings as they allow us to take the necessary precaution and safety factors when using bamboo in real-life applications.

Acknowledgements

The authors highly acknowledge the Ministry of Higher Education Malaysia (MOHE) and Universiti Teknologi Malaysia for the financial support through the FRGS grant, No. 4F727.

References

- [1] Freissinet, Sebastian. "Worries about new composite made airplane." *1001Crash.com* (2011).
- [2] Brouwer, W. D. "Natural fibre composites in structural components: alternative applications for Sisal." In *Seminar, Common Fund for Commodities-Alternative Applications for Sisal and Henecuen*. 2000.
- [3] Pickering, Kim L., MG Aruan Efendy, and Tan Minh Le. "A review of recent developments in natural fibre composites and their mechanical performance." *Composites Part A: Applied Science and Manufacturing* 83 (2016): 98-112.
- [4] Riedel, Ulrich, and Jörg Nickel. "Applications of natural fiber composites for constructive parts in aerospace, automobiles, and other areas." *Biopolymers Online* (2005).
- [5] Baez, Fabian Augusto Lamus, Carlos Felipe Urazan Bonells, and Sofía Andrade Pardo. "Modular Footbridges of Guadua Angustifolia Kunth." *Key Engineering Materials* 668 (2015): 218.

- [6] Lynch, P. "Watch How Bamboo Scaffolding Was Used to Build Hong Kong's Skyscrapershttps." (2016). Retrieved from <http://www.archdaily.com/793364/watch-how-bamboo-scaffolding-was-used-to-build-hong-kongs-skyscrapers>. (Accessed 14 August 2017).
- [7] Wahab, Razak, Othman Sulaiman, Mohd Tarmizi Mustafa, Norashikin Mohd Fauzi, and Izyan Khalid. *Bamboo: Properties and Utilization*. Universiti Malaysia Kelantan, 2013.
- [8] Lee, Andy WC, Xuesong Bai, and Perry N. Peralta. "Selected physical and mechanical properties of giant timber bamboo grown in South Carolina." *Forest Products Journal* 44, no. 9 (1994): 40.
- [9] Clark, Lynn G., Weiping Zhang, and Jonathan F. Wendel. "A phylogeny of the grass family (Poaceae) based on ndhF sequence data." *Systematic Botany* (1995): 436-460.
- [10] Bamboo Botanicals. "Bamboo Anatomy and Growth Habits." (2017). Retrieved from <http://www.bamboobotanicals.ca/html/about-bamboo/bamboo-growth-habits.html>. (Accessed 14 August 2017).
- [11] Amada, S., Ichikawa, Y., Munekata, T., Nagase, Y. and Shimizu, H. "Fiber Texture and Mechanical Graded Structure of Bamboo." *Composites Part B* 28 (1-2), (1997): 13-20.
- [12] Schroder, S. "Bamboo Stem Anatomy." 2011. Retrieved from <http://www.guaduabamboo.com/identification/bamboo-stem-anatomy> (Accessed 30 November 2015).
- [13] Lakkad, S. C., and J. M. Patel. "Mechanical properties of bamboo, a natural composite." *Fibre Science and Technology* 14, no. 4 (1981): 319-322.
- [14] Schröder, S. "Moso - Transverse Surface of Culm Wall." 2011. Retrieved from <https://www.guaduabamboo.com/guadua/comparing-mechanical-properties-of-bamboo-guadua-vs-moso>. (Accessed 30 November 2015).
- [15] Zou, Linhua, Helena Jin, Wei-Yang Lu, and Xiaodong Li. "Nanoscale structural and mechanical characterization of the cell wall of bamboo fibers." *Materials Science and Engineering: C* 29, no. 4 (2009): 1375-1379.
- [16] Sakaray, Harish, NV Vamsi Krishna Togati, and IV Ramana Reddy. "Investigation on properties of bamboo as reinforcing material in concrete." *International Journal of Engineering Research and Application* 2 (2012): 077-083.
- [17] Mohmod, Abd Latif, Ashaari Hj Amin, Jamaludin Kasim, and Mohd Zin Jusuh. "Effects of anatomical characteristics on the physical and mechanical properties of Bambusa blumeana." *Journal of Tropical Forest Science* (1993): 159-170.
- [18] Nogata, Fumio, and Hideaki Takahashi. "Intelligent functionally graded material: bamboo." *Composites Engineering* 5, no. 7 (1995): 743-751.
- [19] Verma, C. S. and Chariar, V. M. "Study of Some Mechanical Properties of Bamboo Laminae". *International Journal of Metallurgical & Materials Science and Engineering* 2 (2), (2012): 20-37.
- [20] Janssen, Jules JA. *Mechanical properties of bamboo*. Vol. 37. Springer Science & Business Media, 2012.
- [21] Hojo, Toshihiko, Zhilan Xu, Yuqiu Yang, and Hiroyuki Hamada. "Tensile properties of bamboo, jute and kenaf mat-reinforced composite." *Energy Procedia* 56 (2014): 72-79.
- [22] Chung, K. F., and W. K. Yu. "Mechanical properties of structural bamboo for bamboo scaffoldings." *Engineering structures* 24, no. 4 (2002): 429-442.
- [23] Li, Xiaobo. "Physical, chemical, and mechanical properties of bamboo and its utilization potential for fiberboard manufacturing." (2004).
- [24] Li, Hai-tao, Qi-sheng Zhang, Dong-sheng Huang, and Andrew John Deeks. "Compressive performance of laminated bamboo." *Composites Part B: Engineering* 54 (2013): 319-328.
- [25] Naik, N.K. "Mechanical and physico-chemical properties of bamboos. Indian Institute of Technology." (2009). Retrieved from <http://www.bambootech.org/files/mechanicaltesting%20report.pdf>. (Accessed 20 October 2015)
- [26] Yap, C. T. M., H. A. Israr, K. J. Wong, and M. Y. Yahya. "Compressive Properties of Hawaiian Gold Timber Bamboo under Different Conditions." *Journal of Advanced Research in Applied Mechanics* 25, no. 1 (2016): 10-18.
- [27] Naik, N. K. "Report on mechanical and physic-chemical properties of bamboo." *IIT Bombay* (2000).
- [28] Mahzuz, H. M. A., Mushtaq Ahmed, Jotan Dutta, and Rezwanul Haque Rose. "Determination of several properties of a bamboo of Bangladesh." *Journal of Civil Engineering Research* 3, no. 1 (2013): 16-21.
- [29] Mathers, G. "Mechanical Testing - Notched Bar or Impact Testing." The Welding Institute. (2016). Retrieved from <http://www.twi-global.com/technical-knowledge/job-knowledge/mechanical-testing-notched-bar-or-impact-testing-071/> (Accessed 12 November 2016).
- [30] Atta, T. "Difference between Izod and Charpy Test." *Green Mechanic* (2016). Retrieved from <http://www.green-mechanic.com/2014/04/difference-between-izod-and-charpy.html>. (Accessed 12 November 2016).
- [31] Rassiah, Kannan, MMH Megat Ahmad, and Aidy Ali. "Mechanical properties of laminated bamboo strips from Gigantochloa scortechinii/polyester composites." *Materials & Design* 57 (2014): 551-559.
- [32] Jindal, U. C. "Development and testing of bamboo-fibres reinforced plastic composites." *Journal of Composite Materials* 20, no. 1 (1986): 19-29.

- [33] Israr, H. A., M. F. Kassim, K. J. Wong, and M. Y. Yahya. "EXPERIMENTAL INVESTIGATION OF PURE BAMBOO PLATE UNDER QUASI-STATIC INDENTATION TEST." *Journal of Transport System Engineering* 2, no. 3 (2015): 25-30.
- [34] Israr, H. A., Kassim, M. F., Razmin, M. R. M. and Wong, K. J. In: Ahmad, Z., editor. *Engineering Materials for Specific Application: Mechanical Properties – Chapter 3: Compressive Behavior of Bamboo Plate.* (2016): 35-53
- [35] Li, Zongjin, Chun-Pong Liu, and Tongxi Yu. "Laminate of reformed bamboo and extruded fiber-reinforced cementitious plate." *Journal of materials in civil engineering* 14, no. 5 (2002): 359-365.
- [36] Richard, Michael J. "Assessing the performance of bamboo structural components." PhD diss., University of Pittsburgh, 2013.
- [37] Liou, N-S., and M-C. Lu. "Determination of Fracturing Toughness of Bamboo Culms." *Time Dependent Constitutive Behavior and Fracture/Failure Processes, Volume 3* (2011): 353-355.
- [38] Amada, Shigeyasu, and Sun Untao. "Fracture properties of bamboo." *Composites Part B: Engineering* 32, no. 5 (2001): 451-459.
- [39] Wang, Fuli, Zhuoping Shao, and Yijun Wu. "Mode II interlaminar fracture properties of Moso bamboo." *Composites Part B: Engineering* 44, no. 1 (2013): 242-247.
- [40] Godbole, V. S., and S. C. Lakkad. "Effect of water absorption on the mechanical properties of bamboo." *Journal of materials science letters* 5, no. 3 (1986): 303-304.
- [41] Thwe, Moe Moe, and Kin Liao. "Effects of environmental aging on the mechanical properties of bamboo-glass fiber reinforced polymer matrix hybrid composites." *Composites Part A: Applied Science and Manufacturing* 33, no. 1 (2002): 43-52.
- [42] Ghavami, Khosrow, Romildo D. Toledo Filho, and Normando P. Barbosa. "Behaviour of composite soil reinforced with natural fibres." *Cement and Concrete Composites* 21, no. 1 (1999): 39-48.