

Variations of riparian vegetation along the river corridors of Sg Johor

Open
Access

Mohamad Hidayat Jamal ^{1,2,*}, Ahmad Khairi Abd Wahab ^{1,2}, Chik Maslinda Omar ², Daeng Siti Maimunah Ishak ²

¹ Department of Hydraulics and Hydrology, Faculty of Civil Engineering, Universiti Teknologi Malaysia, 81310 Skudai, Johor, Malaysia

² Centre for Coastal and Ocean Engineering, Universiti Teknologi Malaysia Kuala Lumpur, Jalan Yahya Petra, 54100 Kuala Lumpur, Malaysia

ARTICLE INFO

ABSTRACT

Article history:

Received 14 November 2016

Received in revised form 19 December 2016

Accepted 23 December 2016

Available online 26 December 2016

Riparian vegetation has been recognized for its remarkable environmental and management implications. Occurred within the dynamic tract of river systems, riparian vegetation is a complex character that often exposed to the changes of river water and river beds. Their spatial extent is strongly controlled by inundation and flood disturbance, which result in the riparian vegetation migration to the point of destruction, if the competition for the area and other sources are lacking. This paper presents the findings of collected riparian vegetation information along Sg Johor at the upstream and downstream of Kota Tinggi. Using Point-Centre-Quarter Method, the vegetation's species, density, basal area, diameter at breast height and relative composition were recorded, identified and classified. *Vitex pubescens* and *Drypetes* spp. dominantly occurred along the upstream and downstream of this river, respectively. Species like *Gymnacranthera bancana*, *Endospermum malaccense*, and *Aquilaria malaccensis* are also found inhabit along Sg Johor bank. Classified as woody vegetation, these vegetations are equipped with buttress roots that enable them to increase soil strength. This paper also suggests that proper study of riparian vegetation along river banks could promote a better understanding of the function of each species, to ensure the sustainability of riparian vegetation as part of river system engineer.

Keywords:

Vegetation, River, River bank, Woody species, Buttress roots

Copyright © 2017 PENERBIT AKADEMIA BARU - All rights reserved

1. Introduction

Riparian vegetation occupied along the river valley is a complex character. Present within the context of riverine ecosystems, riparian vegetation offers variations of ecological, aesthetic and economic benefits, including terrestrial wildlife habitat structure, food resources, stabilizing geomorphic properties along banks and floodplains, and energy subsidies to aquatic and terrestrial ecosystems [1,2]. Riparian vegetation and river form two dynamical systems [3] through several

* Corresponding author.

E-mail address: mhidayat@utm.my (Mohamad Hidayat Jamal)

hydrological, geomorphological and ecological processes. Evolved within the context of flowing water habitats [2], the spatial extent of riparian vegetation along the river banks are controlled by inundation and flood, therefore their pattern and distribution are constantly changes and altered because of the species widely varying tolerances to the surroundings changes and disturbance [4]. Regular exposure to the changes of river water and river beds, some riparian vegetation tends to invade the new area and maintain their dominance, while others might experience migration to the point of destruction, if the competition for the area and other sources are lacking.

The interactions of river and riparian vegetations and its significance to the environment and management have been studied and discussed by many researchers. As such, studies were carried out to elaborate on the importance of riparian vegetation as a control form and dynamics [5, 6]. Although Hickin [7] believes that early studies and discussions were done in general and rather speculative, the progress of these researches commenced at a similar time as river form researches. The influence of riparian vegetation to river evolution and river bank changes was then followed by Perucca *et al.*, [3] and Macfall *et al.*, [8]. The significance of these vegetations as river system engineers which help to protect river environment were fully discussed by Alldredge and Moore [9] and Gurnell [10]. Menashe [11] highlights the impacts of incorporating riparian vegetation in the forest, coastal and riparian area to reduce surface erosion and maintain slope stability. Study was also carried out to understand the interconnection between river's natural flow regime and riparian vegetation and its distribution in response to specific flow components such as flow timing, frequency, magnitude, duration and predictability [2].

Riparian vegetation is also recognized for its capability to influence the resistance to flow [7]. The flow velocities between and above the plants are reduced so that the local resistance to the flow could increase. This will result in the reduction of bed shear stress that associated with soil erosion and sediment transport capacity [12]. According to Ott [13], river vegetation and other flood plain vegetation also help to increase the soil strength. Through root binding [14] and deposition enhancement, further local soil erosion could be reduced by this vegetation [12, 15]. Riparian vegetation also plays a significant part in controlling the upland species dominance and continues to support only wetland species [9]. The riparian soils regulate and transform the energy and materials between terrestrial and aquatic ecosystems [16].

Menashe [11] also believes that the present of riparian vegetation along the river systems has helped the superficial and mass stability of slopes in significant and important ways. As discussed by Hickin [7], vegetation growing on and near the river banks assists in the binding properties by increasing the strength of the bank materials. Based on the enhancement of sediment binding and its strength, and the theory that bank slope is proportional to shear strength, he also suggested that well-vegetated banks will be associated with lower ratios of width of depth than the poorly vegetated banks. Research conducted by Nevin [17] also concludes that riparian vegetation is able to transform braided river into meandering pattern following the designed planting of willow shrubs at selected bends. Further study by Gray and Sotir [18] found that using mechanical reinforcement, woody vegetation helps to protect mass stability and using roots and stems, it controls the modification of slope hydrology through evapotranspiration as part of the soil moisture extraction results. They also summarized that riparian vegetation buttressing and arching characteristics help to anchor and embed stems, by acting as buttress piles or arch abutment in a slope, and counteracting shear stress.

2. Methodology

2.1. Study area

Sungai Johor has been known as the main river in the state of Johor, Malaysia. Flow in the direction of north-south which originates from Mount Gemuruh, the river water is then empties into the Strait of Johor. Sg Johor has a total length of 122.7 km, and its major tributaries including Sg Linggui, Tiram and Lebam. Figure 2.1 shows the upstream and downstream areas of Sg Johor which could be assessed from Kota Tinggi Town.

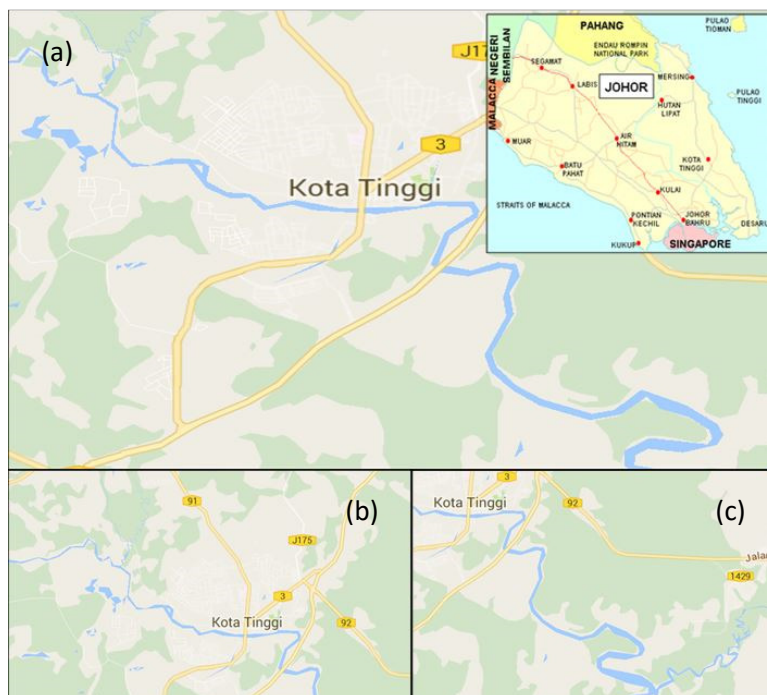

Fig. 2.1. (a) Study area of Sg Johor near to Kota Tinggi; (b) Sg Johor at the upstream of Kota Tinggi; (c) Sg Johor at the downstream of Kota Tinggi

2.2. Data acquisition and preparation

Data collection is divided into two phases. In the first phase, primary data collection has been carried out in March to gather raw data. Ground truth survey, vegetation profile survey, sedimentation collection and cross-section were performed in this phase. While ground truth survey was carried out to calibrate, observe and measure the details on the site before comparison were made to the airborne remote sensing data, vegetation profile survey was intended to gather information about vegetation types and the dominant species inhabits along the river.

Point-Centre-Quarter Method (PCQM) was utilized to conduct this survey because it allows the measurement of the density, basal area, diameter at breast height (DBH) and relative composition of mangrove stand plots while minimizing the biased data [19]. In PCQM, the study area is divided into 1 km x 1 km plots. A 100 m x 100 m quadrates were then established in these plots. In each 100 m x 100 m quadrant, a 100 m transect was then laid out in each quadrant. A centre nodes were established at every 30 m interval by drawing a line perpendicular to the major transects line. DBH (1.3 m above the ground) and height of mature mangrove located nearest to the node was measured. Fig. 2.2 illustrates the plotting area for the PCQM. Recorded data of riparian vegetation is shown in Table 2.1.

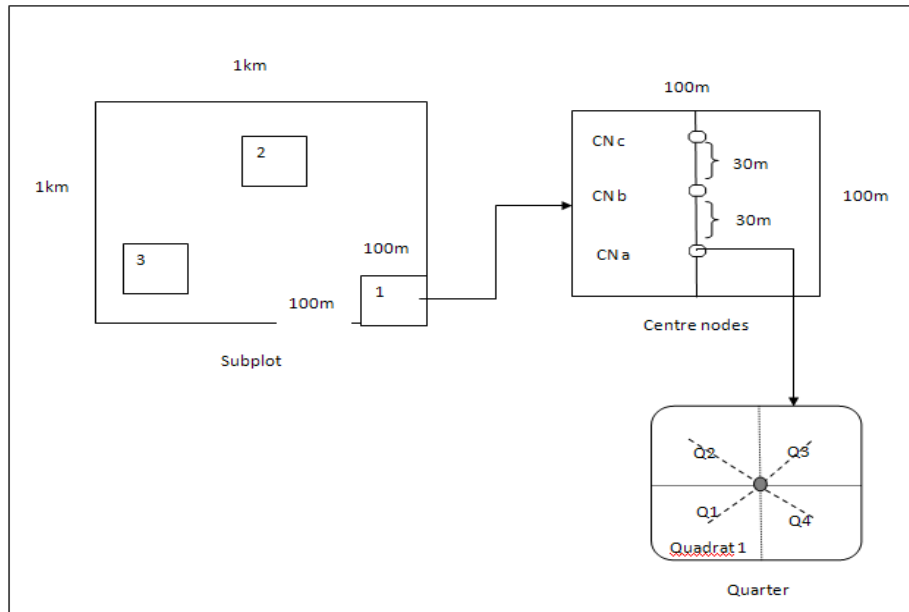

Fig. 2.2. Layout design of the PCQM plotting area

Table 2.1
 Part of documentation for shoreline vegetation profile survey

No	Plot	S_Plot	Q	Species	DBH(cm)	Distance(m)
1	A	A1	Q1	<i>Alstonia angustiloba</i> (Pulai Paya)	175.00	5.00
2	A	A1	Q2	<i>Endospermum malaccense</i> (Sesendok)	65.00	3.00
3	A	A1	Q3	<i>Alstonia angustiloba</i> (Pulai Paya)	65.00	3.50
4	A	A1	Q4	<i>Endospermum malaccense</i> (Sesendok)	60.00	6.00
5	A	A2	Q1	<i>Gymnacranthera bancana</i> (Penarahan)	50.00	5.60
6	A	A2	Q2	<i>Vitex pubescens</i> (Halban)	35.00	4.35

The acquisition of topography map and remotely sensed images were gathered in the secondary data collection. This phase involved with the retrieval of 2006 and 2015 images which covered the upstream and downstream area of Sg Johor and Kota Tinggi town. Remotely sensed images support the historical data which are important to support the analysis of a series of temporal element.

Apart from providing data in raster type that supports red-green-blue (RGB) color composite, the fineness resolution of these images contribute to the easiest feature identification as the details were well presented in the images. Table 2.2 shows secondary data collections, data types and data providers that contributed to this research.

Table 2.2
 Secondary Data Collection

No	Data	Types	Sources
1	Remotely sensed images including of Sg Johor (2006 & 2015)	Spatial data	Malaysian Remote Sensing Agency (MRSA) and Data Provider
2	Topography Maps (2003)	Spatial data	Department of Survey and Mapping Malaysia (DSMM)
3	Riparian Vegetation Types	Non-spatial data	Johor State Forestry Department (JSFD)

These data act to support the analysis in the vulnerability vegetation changes and river morphology assessment. Fig. 2.3 shows the process involved in the remotely sensed images captured for the upstream area of Sg Johor.

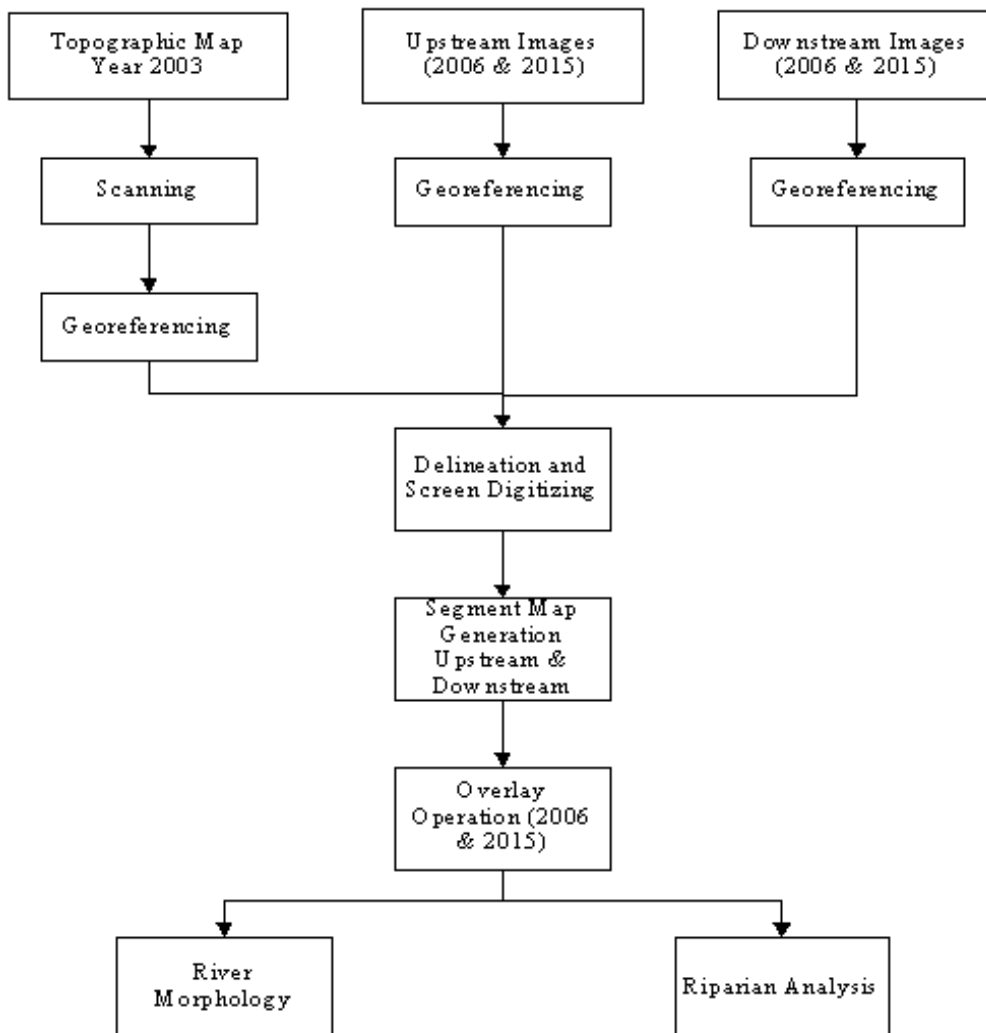

Fig. 2.3. Flow process of remotely sensed images captured for the upstream and downstream areas of Sg Johor

3. Results and discussion

Determination of spatial and temporal variations of riparian vegetation extent along Sg Johor at the upstream and downstream of Kota Tinggi was carried out using satellite images and riparian vegetation profile survey. Riparian vegetation data gathered through the survey is important to evaluate the dominant and submissive vegetation found along the river bank. Figures 3.1 and 3.2 illustrate the distribution of riparian vegetation along Sg Johor, both at the upstream and downstream of Kota Tinggi.

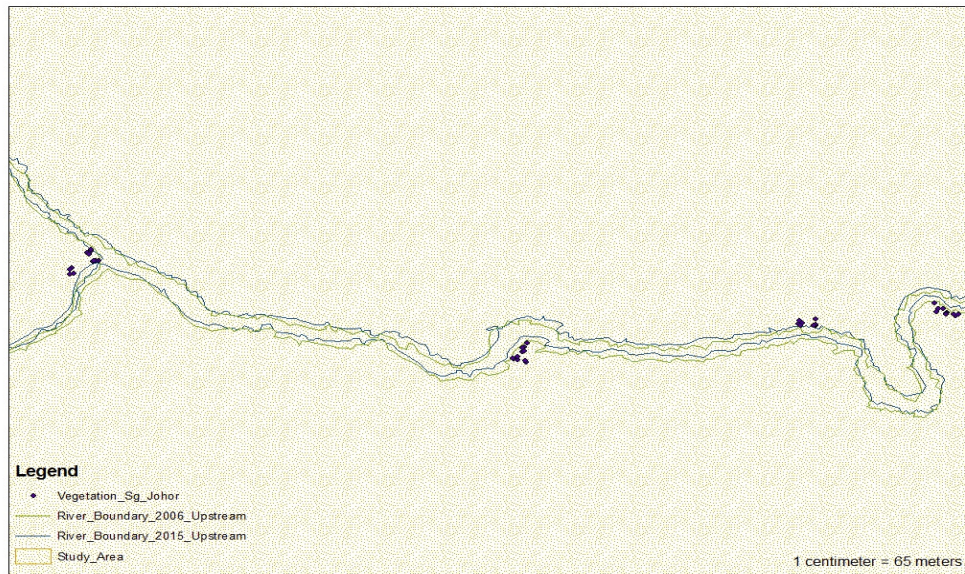

Fig. 3.1. Distribution of vegetation along the upstream river channel

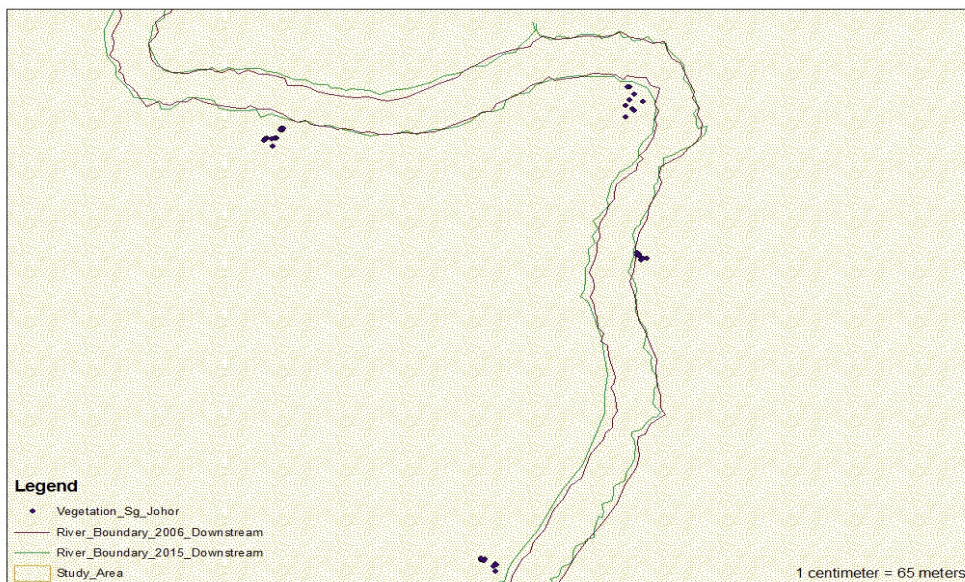

Fig. 3.2. Distribution of vegetation along the downstream river channel

A total of 84 riparian vegetation trees were collected through the survey. From these numbers, 40 riparian vegetation trees were collected at the upstream of Kota Tinggi, while another 44 trees were sampled at the downstream of Kota Tinggi. Figure 3.3 illustrates the total of riparian vegetations species collected along Sg Johor at the upstream and downstream of Kota Tinggi while Table 3.1 shows the number of each species found along the river bank at the upstream and downstream of Kota Tinggi.

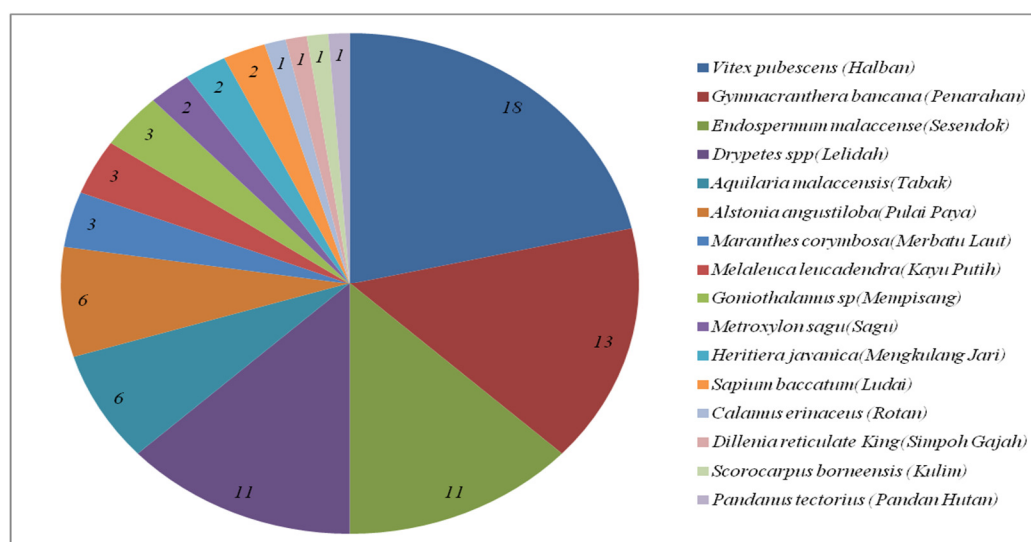

Fig. 3.3. Total of riparian vegetations species collected along Sg Johor banks

Table 3.1

Total species of riparian vegetation found along Sg Johor river banks

Species	Upstream	Downstream	Total
<i>Vitex pubescens</i> (Halban)	14	4	18
<i>Gymnacranthera bancana</i> (Penarahan)	8	5	13
<i>Endospermum malaccense</i> (Sesendok)	5	6	11
<i>Drypetes spp.</i> (Lelidah)	-	11	11
<i>Aquilaria malaccensis</i> (Tabak)	1	5	6
<i>Alstonia angustiloba</i> (Pulai Paya)	3	3	6
<i>Maranthes corymbosa</i> (Merbatu Laut)	-	3	3
<i>Melaleuca leucadendra</i> (Kayu Putih)	3	-	3
<i>Goniiothalamus sp.</i> (Mempisang)	3	-	3
<i>Metroxylon sagu</i> (Sagu)	2	-	2
<i>Heritiera javanica</i> (Mengkulang Jari)	2	-	2
<i>Sapium baccatum</i> (Ludai)	1	1	2
<i>Calamus erinaceus</i> (Rotan)	1	-	1
<i>Dillenia reticulate King</i> (Simpoh Gajah)	1	-	1
<i>Scorocarpus borneensis</i> (Kulim)	-	1	1
<i>Pandanus tectorius</i> (Pandan Hutan)	-	1	1
Total			84

Vitex Puberscens, *Gymnacranthera bancana*, *Endospermum malaccense* and *Drypetes spp.* are commonly found inhabit along the river bank of Sg Johor. Other species such as *Aquilaria malaccensis*, *Alstonia angustiloba*, *Maranthes corymbosa*, *Melaluca leucadendra* and *Goniiothalamus sp.* are also found inhabits along the river bank. *Metroxylon sagu*, *Heritiera javanica* and *Sapium baccatum* are among the species that hardly found inhabits along the river bank, similar to *Calamus erinaceus*, *Dillenia reticulate King*, *Scorocarpus borneensis* and *Pandanus tectorius*.

Illustrated data in the table also reveals that *Vitex pubescens* is the dominant species found inhabits along the upstream of Sg Johor. A total of 14 trees were identified inhabits along this upstream area. *Vitex pubescens* or locally known as Halban or Leban species is a wild woody tree species. It could grow up until 25 m heights and easily found in the forest, river or coppice area and village in Peninsular Malaysia. Sg Johor river bank is also a habitat to vegetation species including *Alstonia angustiloba*, *Melaleuca leucadendra*, *Heritiera javanica*, *Goniiothalamus sp.*, *Dillenia reticulate King* and *Sapium baccatum*. Other species such as *Calamus erinaceus* and *Metroxylon sagu*

are also found inhabit along the upstream area, even though their numbers are lesser than woody trees. Fig. 3.4 (a) and (b) illustrate the details characteristics of *Vitex pubescens* trees.



Fig. 3.4. Characteristics of *Vitex pubescens* trees in clockwise (a) *Vitex pubescens* tree; (b) *Vitex pubescens* leaves

A total of 11 trees sampled along the river bank at the downstream of Kota Tinggi found to be *Drypetes spp.*, making it the most dominant species found in this area. Also known as Lelidah or Lidah-lidah or Arau, *Drypetes spp.* is a woody tree that commonly found inhabit in the Peninsular Malaysia, Sabah and Sarawak. Generally used as utility timber, *Drypetes spp.* which has a texture of fine and even grain is also used as joists, rafters and furniture. Figure 3.5 demonstrates the characteristics of *Drypetes spp.*, including its leaves and trunk. Other species that could also be found in this area are including *Vitex pubescens*, *Gymnacranthera bancana* and *Endospermum malaccense*. *Maranthes corymbosa*, *Scorocarpus borneensis* and *Pandanus tectorius* are submissively found occupied in this area, though their number is small.

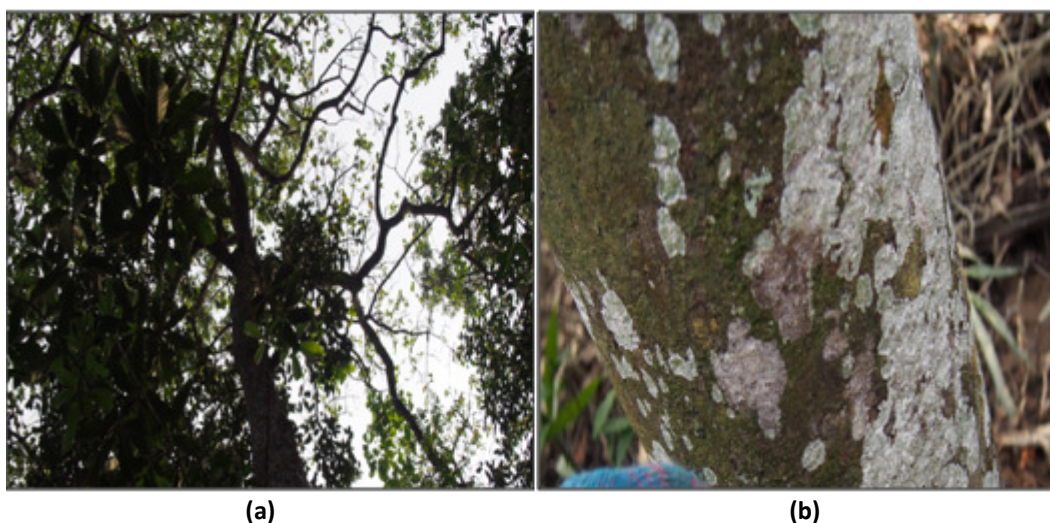

Fig. 3.5. Characteristics of Lelidah trees (a) Lelidah tree; (b) Lelidah trunk

Through the observation, Sg Johor banks in the upstream and downstream of Kota Tinggi is occupied by various woody vegetation, herbaceous growth, shrubs and small trees. In an area where

riparian vegetation samples were taken, identified and classified, woody vegetation has been recognized as the dominant species that occupied most of the area along the river banks. 13 sampled species are belonged to woody vegetation including *Vitex pubescens*, *Gymnacranthera bancana*, *Endospermum malaccense*, *Drypetes spp.*, *Aquilaria malaccensis*, *Alstonia angustiloba*, *Maranthes corymbosa*, *Melaleuca leucadendra*, *Goniothalamus sp.*, *Heritiera javanica*, *Sapium baccatum*, *Dillenia reticulate King*, and *Scorocarpus borneensis*. Other species such as *Metroxylon sagu*, *Calamus erinaceus*, and *Pandanus tectorius* are classified as herbaceous plants.

One of the important advantages of this woody vegetation is the presence of buttress and arch roots, which give numerous benefits to the vegetation and its surroundings. This characteristic acts as buttress piles or arch abutments in a slope, in which, according to MacDonald and Witek, 1994 [20], helps to stabilize the slope. Gray and Leiser, 1982 [21] believes that these root types help to enhance root reinforcement and modify soil moisture. Buttress and arch roots also help to increase stability via increased confining (normal) stress on the failure surface [18]. Vegetation such as *Aquilaria malaccensis*, *Alstonia angustiloba*, *Maranthes corymbosa* and *Drypetes spp.* are equipped with buttress root, hence enable them to prevent the tree from falling over and at the same time gathering more nutrients.

Sg Johor bank in the upstream of Kota Tinggi found to be semi arid rather than the downstream area, results in the occurrence of sloppy sandy banks along the river. Though sandy banks occurred along the river, woody vegetation that occupied along this area helps to stabilize the slope via its buttress and arch roots functions. In the downstream area, the river banks are less sloppy, muddy and wet all the times. This results in the formation of areas that composed of many *Pandanus* species, including *Metroxylon sagu*, *Calamus erinaceus*, and *Pandanus tectorius*. Observation carried out by boat along the river reveals that most of the river banks along the downstream of Kota Tinggi are occupied by these *Pandanus* species.

The fragile nature of riparian vegetation could be distressed by various anthropogenic activities as well as environmental variables [22]. Influence of land use [23], reduction of flow variation and lack of sediment transport [24], for examples result in the riparian vegetation deprivation. Different dominant species which occurred at different location along Sg Johor could signifies the species' tolerant towards these factors. Therefore, there is a need to understand the autecology of a species in order to develop cause-and-effect relationships between attributes of flow and life-stages of that species [25]. This also will help to enhance the understanding of hydrologic requirements for survival from germination, to reproductive age, to senescence as well as the interactions with physical and biotic factors such as channel change processes and competition for specifying flow requirements [2]. Vegetation alone may be relatively ineffective where hydrologic influences, fluvial processes, or wave attack repeatedly interrupts natural plant succession and favors less effective species, and also futile in the presence of deep-seated instability and active mass wasting [11].

4. Conclusion

Riparian vegetation identification that was performed in this study is important to understand the significances and values of this vegetation in the river morphological evolution. Although riparian vegetation is characterized by complex interactions with the river, vegetation such as *Vitex pubescens*, *Gymnacranthera bancana*, and *Endospermum malaccense* that present along the river bank of Sg Johor have shown benefits in slope stability and fluvial processes. However, further study still needs to be carried out to better understood the function of each species, in order to commence proper actions and ensuring the sustainability of riparian vegetation as part of river engineer is protected.

Acknowledgements

Authors would like to express special thanks and gratefulness to Research University Grant (Ref No: 03G02), Universiti Teknologi Malaysia for funding this research and Johor Forestry Department for their assistance and guidance in data collection.

References

- [1] Pusey, Bradley J., and Angela H. Arthington. "Importance of the riparian zone to the conservation and management of freshwater fish: a review." *Marine and Freshwater Research* 54 (2003): 1–16.
- [2] Merritt, David M., Michael L. Scott, N. Leroy Poff, Gregor T. Auble, and David A. Lytle. "Theory, methods and tools for determining environmental flows for riparian vegetation: riparian vegetation-flow response guilds." *Freshwater Biology* 55 (2010): 206–225.
- [3] Perucca, Eliana, Carlo Camporeale, and Luca Ridolfi. "Significance of the riparian vegetation dynamics on meandering river morphodynamics." *Water Resources Research* 43 (2007): W03430. Accessed on May 5, 2015.
- [4] Bertoldi, Walter, Nick A. Drake, and Angela M. Gurnell. "Interactions between river flows and colonizing vegetation on a braided river: exploring spatial and temporal dynamics in riparian vegetation cover using satellite data." *Earth Surface Processes and Landforms* 36 (2011): 1474–1486.
- [5] Lane, Emory Wilson. "A Study of the Shape of Channels Formed by Natural Streams Flowing in Erodible Material." *US Army Corps of Engineers, Missouri River Division, Sediment Series* 9 (1957): 106.
- [6] Leopold, Luna Bergere, and M. Gordon Wolman. "River Channel Patterns-braided, Meandering and Straight." US Geological Survey Professional Paper 282B. US Geological Survey: Reston, VA (1957): 39–85.
- [7] Hickin, Edward J. "Vegetation and River Channel Dynamics." *Canadian Geographer* XX. VIII. 2. 1. (1984): 112–126.
- [8] Macfall, Janet, Paul Robinette, and David Welch. "Factors Influencing Bank Geomorphology and Erosion of the Haw River, a High Order River in North Carolina, since European Settlement." *PLoS ONE* 9, no. 10 (2014). Accessed on May 5, 2015.
- [9] Alldredge, Blake and Georgianne Moore. "Assessment of Riparian Vegetation Sensitivity to River Hydrology Downstream of a Major Texas Dam." *River Research and Application* (2012). Accessed on December 23, 2015.
- [10] Gurnell, Angela. "Plants as river system engineers." *Earth Surface Processes and Landforms* 39 (2014): 4–25.
- [11] Menashe, Elliott. "Bio-Structural Erosion Control: Incorporating Vegetation into Engineering Designs to Protect Puget Sound Shorelines". Puget Sound Research (2001).
- [12] Crosato, Alessandra, and May Samir Saleh. "Numerical study on the effects of floodplain vegetation on river planform style." *Earth Surface Processes and Landforms* 36 (2011): 711–720.
- [13] Ott, Robert A. "Factors affecting stream bank and river banks stability, with an emphasis on vegetation influences." In *Region III Forest Resources and Practices Riparian Management Annotated Bibliography*, edited by Martha Welbourn Freeman, 21–40. Alaska Department of Natural Resources, Division of Forestry, 2000.
- [14] Pollen-Bankhead, Natasha, and Andrew Simon. "Enhanced application of root reinforcement algorithms for bank-stability modeling." *Earth Surface Processes and Landforms* 34, no. 4 (2008): 471–480.
- [15] Sandercock, P. J., Janet Hooke, and J. M. Mant. "Vegetation in dryland river channels and its interaction with fluvial processes." *Progress in Physical Geography* 41 (2007): 107–129.
- [16] Zaines, George, and Robert Emanuel. "Stream Processes for Watersheds Stewards." The University of Arizona Cooperative Extension (1-28). Retrieved on January 18, 2015, from: <http://cals.arizona.edu/pubs/natresources/az1378g.pdf>.
- [17] Nevins, T. H. F. "River training - the single-thread channel." *New Zealand Engineering* (1969): 367-73.
- [18] Gray, Donald H., and Robbin B. Sotir. *Biotechnical and Soil Bioengineering Slope Stabilization: A Practical Guide for Erosion Control*. John Wiley and Sons, 1996.
- [19] Cintron, Gilberto, and Yara Schaeffer Novelli. "Methods for studying mangrove structure." In *The Mangrove Ecosystem: Research Methods*, edited by Samuel C. Snedaker and Jane G. Snedaker, 91–113. UNESCO. 1984.
- [20] MacDonald, Keith B., and Bonnie Witek. *Management Options for Unstable Bluffs in Puget Sound, Washington*. *Coastal Erosion Management Studies* 8 (1994).
- [21] Gray, Donald H., and Andrew T. Leiser. *Biotechnical Slope Protection and Erosion Control*. Van Nostrand Reinhold Company, New York, 1982.
- [22] Mligo, Cosmas. "Diversity and Distribution Pattern of Riparian Plant Species in the Wami River System, Tanzania." *Journal of Plant Ecology* (2016).

-
- [23] Njue, Naomi, Eric Koech, Joseph Hitimana, and Peter Sirmah. "Influence of Land Use on Riparian Vegetation, Soil and Water Quality: An Indicator of Biodiversity Loss, South West Mau Forest, Kenya." *Open Journal of Forestry* 6 (2016): 373–385.
- [24] Malik, Azim U., and John S. Richardson. "Riparian Vegetation Change in Upstream and Downstream Reaches of Three Temperate Rivers Dammed for Hydroelectric Generation in British Columbia, Canada." *Journal of Ecological Engineering* 35, no. 5 (2009).
- [25] Van Der Sman, A. J. M., N. N. Joosten and C.W.P.M Blom. "Flooding Regimes and Life-History Characteristics of Short-Lived Species in River Forelands." *Journal of Ecology* 81 (1993): 121–130.