

Enhancing Multiple Analogue Inputs Programmable Logic Controller (PLC) Module for Industrial Controlling Process and SCADA Monitoring

Ahmed S.M. Ayyad, Mohamad Shukri Abdul Manaf, Norul Ashikin Norzain,
Nicholas Philip, and Shafishuhaza Sahlan*

Faculty of Electrical Engineering, Universiti Teknologi Malaysia, 81310 UTM Skudai, Johor, Malaysia.

*Corresponding author: shafis@fke.utm.my, Tel: 607-5535441, Fax: 607-5566262

Abstract: Different from the past, in recent years, an increasing number of technology solutions have been started to be designed for the data acquisition in industries and it is applications due to the fast development in the field of industrial control and recently the increase of the demand of high quality, accurate and fast devices working together with controllers such as programmable logic controllers. These devices are meant to be used and designed for multiplexing a number of analogue signals into PLCs and industrial processors based data gathering devices. In Industries, Machines become more autonomous by letting controllers acquire and process several various industrial variables at a short time by keeping tabs from afar. Recently, designed PLC modules are developed and fabricated with additional input and output devices, cost effective and user friendly because there is significant interest from industries owners who prefer to have faster data acquisition and faster processing in a short time rather than using a conventional external modules for PLCs. Besides, the interest of using multiplexing devices has increased since these devices are cheaper and faster than normal PLC's modules. Accordingly, in this study, full design of the enhanced analogue input module to acquire more number of industrial variables using small PLCs limited by its input capacity together with a sample software application of industrial control are presented using PLC programmer and SCADA system. In the presented software application, a group of sensors and actuators are used to simulate an autonomous industrial plant. Although the presented software application is just a simple example of how industrial process can be used, it has the potential of affecting all areas improving day to day life of the operators and engineers

Keywords: Programmable Logic Controller, Multiplexer, Transmitter, SCADA, Industrial Controlling Process

© 2017 Penerbit UTM Press. All rights reserved

1. INTRODUCTION

Multiplexing technology has realized the two major functions of which channel can implement the communication between the receiver and transmitter which it can be employed to transfer several information simultaneously. In addition, multiplexers can implement the related signal gathered into one destination, and then as a signal it can be implemented by the system to deal with. The two or more signals ensure that multiplexing technique will not take the same space at the same operating frequency and same time. Its implementation methodology can be realized as: by the addition of new physical links, where the various signals is shared as a whole bandwidth of the frequency spectrum, or by making the chance to access the link by each user. The benefits of this technology can be realized in the installation, cost, reliability, checking the convenience way of maintenance, and can attain the required performance levels [1].

Nowadays, in heavy duty and huge industry PLC has

been widely used especially in automation process. There are several functions of PLC have been developed recently such as networking, process control, motion control and relays control. In addition, PLC is fabricated with multiple inputs and outputs digital and analogue with different arrangements to enable users for easier work. Besides that, it may have some external input and output port with its modules that attached to the PLC computer network [2].

Most control actions are performed automatically by PLCs. To refer to centralized systems, the term SCADA is usually used which has the ability to monitor and control entire sites, or any complexity of systems that spread out over huge areas. Functions of host control are usually restricted to supervisory level interference. For example, when through part of an industrial process is controlled by PLC such as the flow of cooling water, the change of the set points for the flow might be allowed by the SCADA system as well as enabling the alarm conditions, such as loss of flow of the water in the tank and the case of high

temperature, to be displayed and recorded. The PLC will pass the feedback control loop through it, while the SCADA system used to monitor the overall performance of the loop [3].

2. RESEARCH METHOD

Nowadays, with the aid of CMOS transistor technology, it can be widely used and implemented into several industrial applications along with programmable logic controller (PLC) to control and monitor several industrial variables using only one PLC. Increasing the number of analogue inputs for PLC's input terminals can be achieved by using the idea of switching and multiplexing using some electronic components and conditioning circuits to achieve higher performance and smaller circuit size compatible with PLC to monitor maximum number of industrial variables.

Multiplexer (or MUX) is a circuit that allows several inputs to be selected by user, as specified by a digital control signals. The analogue signal presented on the selected source input will be passed through to the output. For example with MUX 8 8 analogue current loops can be switched to 1, 2 or 4 outputs. By doing so expenses on measuring-regulation systems are reduced due to the very expensive use of multi-channel A/D converters. Channel selection is made with control inputs A, B, C and D. For control inputs we use 24V digital outputs from PLC [4]. The main three functions of Multiplexer are: pre-processing the analogue signals coming from each sensor or to guide these incoming signals from the sensors to any appropriate signal processing units multiplexing the signals coming from each sensor in time domain, and lastly building the system of some simple concepts applied [5].

Controller is known as the mind or brain of the whole system. The functions of any controller are to compute the signal produced due to the response or performance of the process to generate desired output [6].

In comparison to other regular normal computers or machineries PLC has different characteristics. Firstly, the design is used to automatically run without full supervision. Also, to meet some special requirements in industrial environments and design PLC has the functions that are purposely built where it can stand against harsh environment where dust, heat, moisture, shock and various temperatures have exist in order to use it in industries. Subsequently, regular machineries and normal computers don't have the capability to operate and observe the programming ability and monitoring where it does not have the features that PLC does [2].

Mostly, PLC realizes several variable control signals. The input signals to the controller are: operation control signals, temperature variables, operation modes, safety/protect signals, flow control signal and level control signal, etc. Most of control operations of different variables industrial system are observed by PLC program, such as registration, elimination and display of fault occurrences, water level in the tank, etc. [7]. The choice of input-module products and architecture for PLC systems depends upon the input signal levels that need to be monitored. The signals, from various types of process

control and sensors variables to be monitored, can involve input signal ranges from to ± 10 mV to ± 10 V.

In the designing stage a setup of hardware and software is carried out as to achieve the multiple built in analogue input terminal input module for a single PLC. The idea of this project is combining two different parts; multiplexing circuit, into a common reason in which can maximize the number of industrial analogue variables processed by a single PLC and use PLC as a main controller to control these industrial variables as process controller interfaced with SCADA system for monitoring purpose.

2.1 System Hardware

A proper implementation of electronic parts of the system comprises of the multiplexing circuit, conditioning circuit, amplifiers and current loop transmitter would yield to acquire desired output signal and have better performance with high signal efficiency.

There are four major parts in this hardware development of multiple analogue inputs module which as follow, the type of sensors used, the conditioning circuits and multiplexer circuit. The multiplexer circuit is used to increase number of analogue inputs used for single PLCs limited by their input capacity. The type of multiplexer circuit involved is one of MUX36xxx family produced by Texas Instruments. Adding a conditional circuits consist of precision instrumentation amplifier to boost the voltage output acquired from thermocouples sensor and 4-20 mA current-loop transmitter to transmit analogue 4-20 mA signals over an industry-standard current loop, current to voltage converter and a bridge circuit conditioner designed for bridge sensors such as RTDs. multiplexer will produce output of 4-20 mA which suits PLC's input current range but it is suggested that the current output should be converted to voltage for easier output measurement, so trans-impedance amplifier / current to voltage converter is used to convert current to a proportional voltage. Figure 1 below show the complete block diagram for the entire proposed project and Figure 2 shows the schematic circuit for the hardware part of the system.

The main hardware components are discussed in details as follows:

- 1) The MUX36S08 from (MUX36xxx) family is modern complementary metal-oxide semiconductor (CMOS) analogue multiplexers (muxes). The MUX36S08 offers 8:1 single-ended channels, it can work equally well with either dual supplies from ± 5 V to ± 18 V or a single supply from 10 V to 36 V. They also perform well with symmetric supplies such as $V_{DD} = 12$ V, $V_{SS} = -12$ V, and un-symmetric supplies. It has very low on and off leakage currents, allowing this multiplexer to switch signals from high input impedance sources with minimal error [5]. Figure 3 show the pin configuration of the chip used.

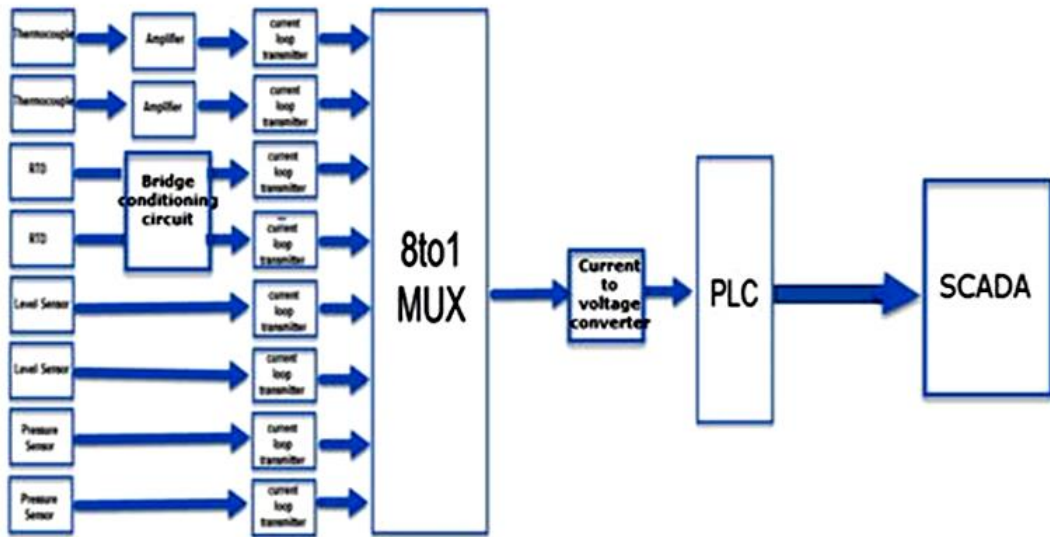

Figure 1. Functional Block Diagram of Overall System

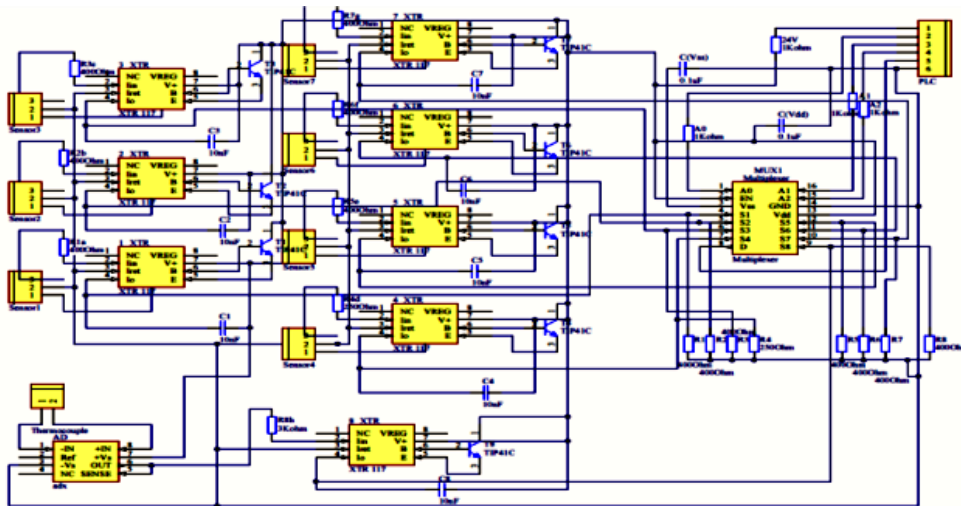

Figure 2. Schematic diagram of Enhanced Analogue Input Module

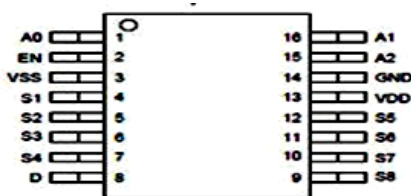

Figure 3. Pin configuration of MUX36S08

- 4-20 mA Current Loop Transmitter the XTR117 is a precision current output converter designed to transmit analogue 4-20mA signals over an industry-standard current loop. Figure 3.17 shows basic circuit connections with representative simplified input circuitry. The XTR117 is a two-

wire current transmitter. Its input current (pin 2) controls the output current. A portion of the output current flows into the V+ power supply, pin 7. The remaining current flows in Q1 [8].

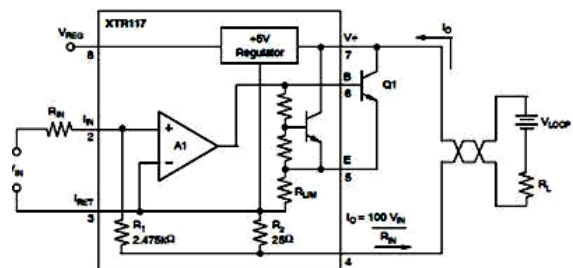

Figure 4. Functional Block Diagram of XTR 117

The XTR117 is a current-input device with a gain of 100. A current flowing into pin 2 produces $IO = 100 \times IIN$. The input voltage at the IIN pin is zero (referred to the IRET pin). A voltage input is converted to an input current with an external input resistor, as shown in Figure 3.17. Typical full-scale input voltages range from 1V and upward.

After all main components were successfully soldered on the PCB board; circuit assembly was done by soldering the rest of the components on the main PCB board such as resistors, transistors, capacitors and the breakout boards on the donut board. The main board of the enhanced module is shown in Figure 5.

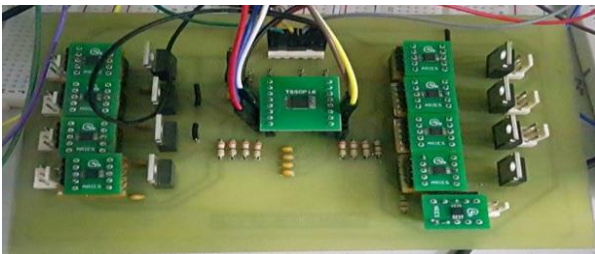

Figure 5. Enhanced Analogue Input Module

2.2 System Hardware

2.2.1 CX-Programmer software

To program the PLC, CX-Programmer software was utilized by using ladder diagram language. After the ladder diagram is built, using a USB cable the program is transferred to the PLC. The sequential operations of ladder diagram will be performed once the program has been successfully transferred to the PLC. To monitor the sequence of the ladder diagram program CX-Programmer must be connected to the PLC.

2.2.2 CX-Supervisor (SCADA)

The dedication of CX-Supervisor is to the operation of PC based visualization and machine control and design. It is not only offering a powerful tool for the design of the most complex applications, but it is also simple and easy to use for any small control and supervisory tasks. For a wide range of PCs based HMI requirements CX-Supervisor boosts several powerful functions. Libraries of simple applications can be rapidly initiated with the aid of large number of predefined functions and, as well as so complicated applications can be created with such powerful programming language. Standard PCs and desktop Computers run with Microsoft Windows can run along with CX-Supervisor software. CX-Supervisor is intuitive and simple to use, it allows rapid configuration, testing and debugging of any project. Two separate executable Windows programs are constructing CX-Supervisor, CX-Supervisor Development environment and CX-Supervisor Runtime environment.

3. RESULTS AND ANALYSIS

During the experiment, the components were tested individually to assure that the module can process several variables during the operation. The PLC switching control

Program shown in Figure 7 was tested in the beginning to assure that the programming is working as expected in the operation with varying the switching time between the digital control pins of the PLC. The module proposed is cost effective compared to conventional external modules exist in the market where the total cost of the project is (456.40RM) around (100\$). However, other modules in the market is being sold with price of (900\$) such as Omron PLC module cs1w-pts56 sold by zwell and Omron CJ1WDA08V PLC module. Moreover, the enhanced module has smaller scale compared to the conventional modules exist in the market which make it flexible to use and easily fit in any electrical panels. Figure 6 shows the data memory of OMRON PLC. Voltage values coming into PLC are normally saved in some of data memory locations. It can be clearly seen that the voltage values in data memory location (D100 up to D107) are varying which give the indication of the ability of multiplexer to acquire and process several industrial variable at a short time (10 ms).

Start Address:	100	On	Off	SetValue						
ChangeOrder		ForceOn	ForceOff	ForceCanc						
D00000	+0	+1	+2	+3	+4	+5	+6	+7	+8	+9
D00010	0020	0020	0040	0040	0080	0080	0080	0000	0000	0000
D00020	2689	0808	0080	0006	0007	0004	0005	0006	0007	0000
D00030	0867	FFFE	FFFF	0000	0000	0000	0000	0000	0000	0000
D00040	0008	0289	0000	0000	0000	0000	0000	0000	0000	0000
D00050	0000	0100	0000	0000	0000	0000	0000	0000	0000	0000
D00060	0003	0000	0000	0000	0000	0000	0000	0000	0000	0000
D00070	0016	0000	0000	0000	0000	0000	0000	0000	0000	0000
D00080	2400	0000	0000	0000	0000	0000	0000	0000	0000	0000
D00090	0000	0000	0000	0000	0000	0000	0000	0000	0000	0000
D00100	0000	0000	0000	0000	0000	0000	0000	0000	0000	0000
D00110	0774	0C6E	0787	0788	05E8	05E8	06DE	0867	0008	0009
D00120	0000	0000	0000	0000	0000	0000	0000	0000	0000	0000

Figure 6. PLC Data Memory

In addition, the graph shows that the hardware is able to expand the analogue input terminals of the PLC from only one built in analogue input to 8 analogue inputs by observing channel D100 in the data memory which indicates a change of the values according to the time change. As a result of this project, it can achieve the objective of this project.

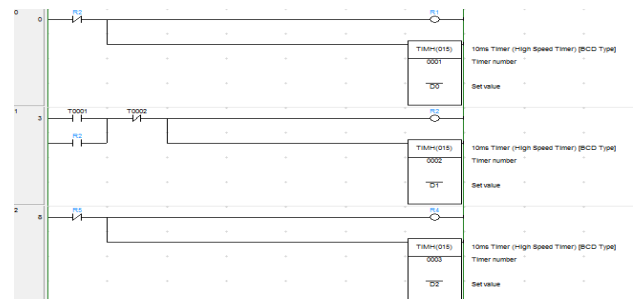

Figure 7. The PLC Switching Control Program

Several experiments were done by varying the timers using the memory of the PLC starting experiments from 200ms until 10ms .Shown in figures below oscilloscope graphs of different industrial variables acquired by PLC. The graphs also show the signals acquired using the enhanced module before and after applying conditioning circuit in which it can enhance signal accuracy and eliminate signals noise.

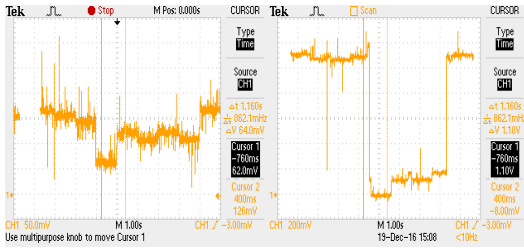

Figure 8. Voltage Values Variation using Multiplexer at (1second)

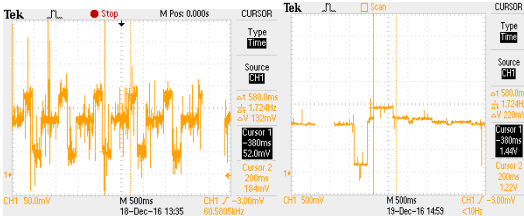

Figure 9. Voltage Values Variation using Multiplexer at (500 millisecond)

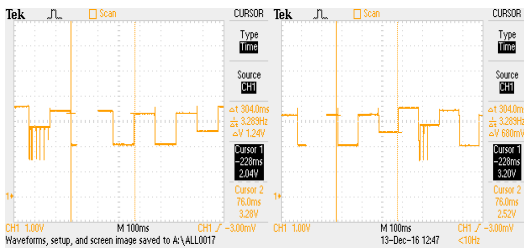

Figure 10. Voltage Values Variation using Multiplexer at (50 millisecond)

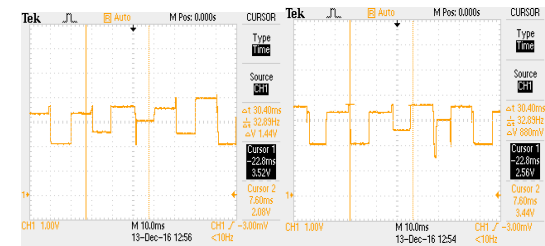

Figure 11. Voltage Values Variation using Multiplexer at (10 millisecond)

It shows that the PLC is able to process data and switch several industrial variables inputs acquired in a very good time (10ms) to be used to obtain and process the data from industrial variables in normal industrial applications where time of 100 millisecond is fast enough to process data acquired from machines in industries where it is sufficient for industrial process applications. This is a very good time to obtain and process the data from industrial variables.

However, the multiplexer circuit can switch and process variables faster than the PLC where it can switch within (0.35µs) where the speed of the PLC used in the experiment can't realize it because the PLC used is (CPIH) relay type PLC but for faster performance a transistor type PLC can be used since it has faster switching and processing time .Figures below shows the voltages versus time which shows different values o within different varied timers used in the experiments.

A relay type is a good choice when switching either ac or dc at a high voltage and current ranges but for faster performance especially for applications require high speed a transistor type PLC can be used since it has faster switching and processing time in picoseconds .Figures below shows the voltages versus time which shows different values within different varied timers used in the experiments.

Designing graphics, monitoring and controlling the state of application can be done by user through screen of the operator's PC. Observation of the temperature, pressure, level and flow whether it is high or low through the operator's PC screen. It provides the ability to open the valve, start plant pumps, and control the level, temperature and pressure level. Once the program is running the event/error log will be displayed on the screen. The system can be started using push buttons that are placed on each page and moving from page to another is possible using push buttons. Sliders used to control the level/amount of pressure, temperature and level of the tanks as shown in Figure12 and Figure 13 below.

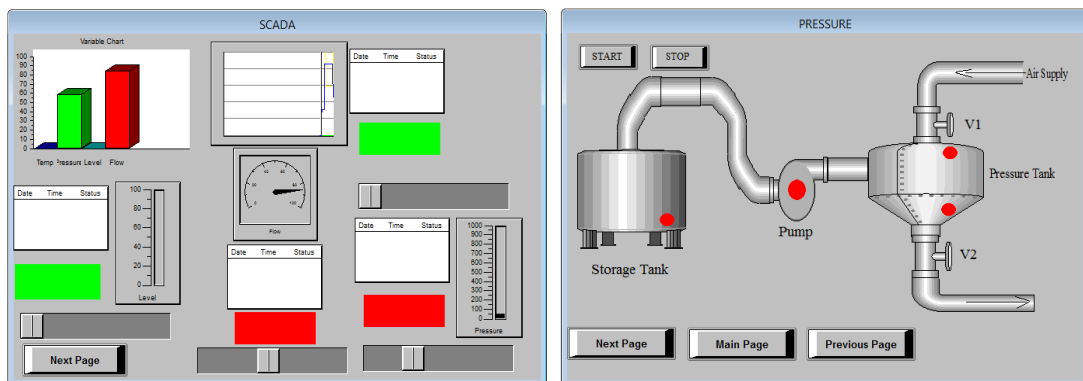

Figure 12. Voltage Values Variation using Multiplexer at (10 millisecond)

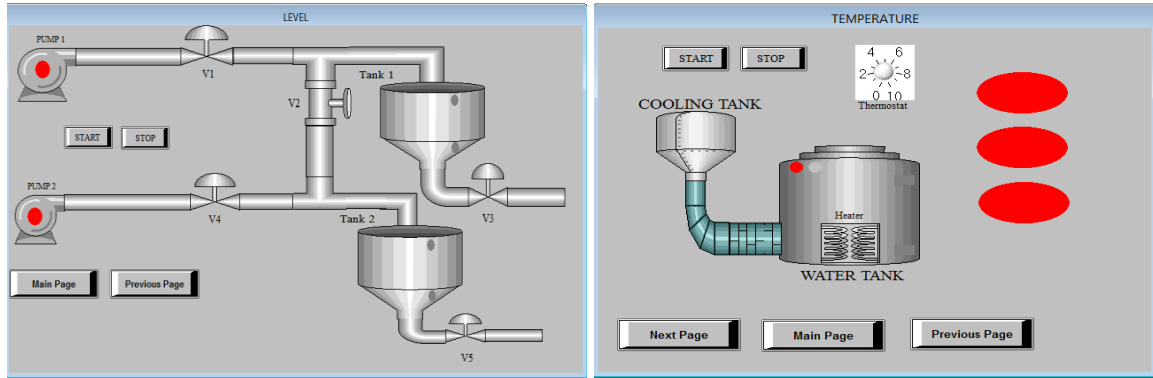

Figure 13. Level and Temperature Monitoring Page

4. CONCLUSION

Through this newly designed, developed and fabrication of multiple analogue Input PLC module, it can increase the number of analogue inputs for small PLCs limited by its analogue input capacities where it increases the number of analogue inputs of (OMRON CP1H) PLC from 4 built in analogue input terminals to 32 analogue inputs through small scale analogue switching/multiplexing circuit used in this project which can function as switch for data acquired from several analogue industrial variables to be changed respectively as configured in the PLC programming within a short time that is compatible with PLC running cycle which enable the PLC to read and process the incoming signals within its running cycle time and to replace the conventional analogue I/O module exist in the market.

In this study, a sample application of SCADA system is applied consisting of a number of networked human machine interface (HMI) pages to be displayed in any control room in industries to monitor and control different variables obtained from several sensors used in this project. Although it is just a very simple example of SCADA interface system, it shows that a whole plant can be controlled and monitored from afar which can have the potential of affecting all areas of day to day operations of the machines running and the whole plants in general.

ACKNOWLEDGMENT

The author would like to acknowledge the Geran Universiti Penyelidikan (Vote No: 14J58) under Universiti Teknologi Malaysia.

REFERENCES

- [1] D. Zhang, et al., "Common Mode Circulating Current Control of Interleaved Three-Phase Two-Level Voltage-Source Converters with Discontinuous Space-Vector Modulation," 2009 IEEE Energy Conversion Congress and Exposition, Vols 1-6, pp. 3906-3912, 2009.
- [2] Z. Yin Hai, et al., "A Novel SVPWM Modulation Scheme," in Applied Power Electronics Conference and Exposition, 2009. APEC 2009. Twenty-Fourth Annual IEEE, 2009, pp. 128-131.
- [3] X. S. Li, et al., "Analysis and Simplification of Three-Dimensional Space Vector PWM for Three-Phase Four-Leg Inverters," IEEE Transactions on Industrial Electronics, vol. 58, pp. 450-464, Feb 2011.
- [4] Liu, Jiang Cai. "The Study of PLC Control Technology Application in Motor VVVF System." Applied Mechanics and Materials. Vol. 203. Trans Tech Publications, 2012
- [5] Chen, Shu Wang, Shu Hai Wang, and Xiao Qin Xie. "Design of Current Temperature Transmitter Circuit." Applied Mechanics and Materials. Vol. 63. Trans Tech Publications, 2011.
- [6] Zumbahlen, H. "Linear Circuit Design Handbook, Newnes, 2008." 978-0
- [7] Gopal, Madan. Digital Cont & State Var Met. Tata McGraw-Hill Education, 2012
- [8] Albert O'Grady. Precision Signal-Processing and Data-Conversion ICs for PLCs Now Have More Performance at Less Power, Size, and Analog Dialogue 40-08, August (2006)