

DATA-DEPENDENT IN ROLE-BASED GOAL MODELING

¹ROHAYANTI HASSAN, ²NOR ASHILA ABDUL RAHMAN, ³RAZIB M. OTHMAN, ⁴WAFAA ABDULLAH

^{1,2,3}Department of Software Engineering, Faculty of Computing, Universiti Teknologi Malaysia, Malaysia

⁴Computer Science Department, Nawroz University, Computer and I.T College, Duhok, Iraq

E-mail: ¹rohayanti@utm.my, ²ashilarahman@gmail.com, ³razib@utm.my, ⁴wafaa.mustafa@nawroz.edu.krd

ABSTRACT

Role-based goal modeling demonstrates an improvement on stakeholders' role representation and its data element in modeling a system to-be. Since the requirements might be contributed from multi stakeholders, several goals are possible to rely on similar sources of requirements. In another scenario, other stakeholders may interact with the outcome from other sub goals, where this demonstrates the occurrence of dependency. Dependency implies different feasibility and adequacy of each goal and sub goal. Data dependency happens when the data can either be an input or output from one goal to another goal. Consequently, the data has been changed or intervened from one goal to another. This paper discusses the integration of data element into role-based goal modeling from the aspect of: (i) how to form the data dependency in role-based goal realization graph and (ii) how to assess the new formation in terms of feasibility and adequacy. The conflict and priority of the data dependency will be determined in order to estimate the complexity and risk along the process. This new improvement of goal modeling will be validated using a real case study taken from Plant Integrated System.

Keywords: *Multi stakeholders, Stakeholder's role, Data dependency, Complexity, Risk*

1. INTRODUCTION

Stakeholders may be classified under several viewpoints which represent the structuring of different stakeholders' perspectives. There are various stakeholders with their own roles and objectives [1] that need to be analyzed by the requirement engineer. Stakeholders are required to accomplish a lot of different activities during the development. The variation of stakeholders' goals and priorities is one of the factors that will lead to requirement conflict and overlap [2].

On the other hand, Pohl and Klaus [3] defines goal as an intention with regard to the objectives, properties, or use of the system. In requirements engineering, goal is important to represent the stakeholder's intentions and objectives once the requirements have been elicited. Meanwhile, data is a collection of information extracted from elicited requirements. Based on Pohl's definition above, data can also be implied as the properties or elements to the goal. In another work, Carlshamre et al. [4], only a few requirements are regarded as singular, that each of them cannot be treated as isolated in which any change of one requirement may cause a number of changes brought to other

requirements. Based on this idea, one data is attributed from several requirements, may be contributed from multi stakeholders and goals as well. Thereby, data dependency has an impact to the performance of goal formation.

Figure 1 depicts the input to the interpretation process. The data are syntactic entities consisting of patterns with no meaning because they act as an input to the interpretation process [5]. The uncertain distinction between data and stakeholder's goal might impair the combination as well as the utilization for the development of system-to-be. Multi stakeholder environment is assumed where the decision-making stage receives input from and returns output to its external environment. Based on this challenge, this paper has outline the research question that focuses on how to integrate and evaluate data element in goal modeling.

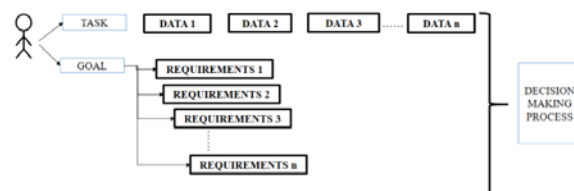

Figure 1: Input to interpretation process

Therefore, this paper is structured to discuss on how to integrate and evaluate data element in goal modeling in determining the complexity of dependency of data when dealing with multi-stakeholders to perform a lot of different activities. Data dependency happens when the data can be an input or output from one goal to another goal. Consequently, the data has been changed or intervened from one goal to another. The integration of data element in role-based goal modeling are discussed from the aspect of: (i) how to form the data dependency in role-based goal realization graph and (ii) how to assess the new formation in terms of feasibility and adequacy. This study has innovated a new role-based goal modeling for better goal representation of the system-to-be. Motivated from Boness et al. [12], goal realization graph can be used to represent the goals of the system-to-be.

2. RELATED WORKS

Goals allow for capturing stakeholder needs and can be used for exploring, analyzing and selecting architectural design alternatives. The assessment of each goal at the early stages of development could normally establish the reason behind the available solutions that could affect those needs. Besides, the notion of goal models has been enhanced which allows quantitative and real-life measurements, making the assessment of qualitative measurements more accurate. The significance of the goal assessment is to estimate the feasibility and adequacy of each goal in spite of finding out the completeness on how all goals are understood and realized. Table 1 tabulates the summary of goal modeling study.

Generally, in software development life cycle, the requirements analyst uses goal model to analyze different design alternatives. Subramaniam et al. [7] in their study implemented the goal model that applied inter-actor dependencies which make the actor goal accomplishment reliant on the other actor involved. They also mentioned that with goal models, the requirements analyst is able to: (i) evaluate the satisfaction of goals, (ii) determine the high-level requirements and (iii) assess the design alternatives. In their study, they demonstrated an approach of finding soft-goal satisfaction using inter-actor dependencies using the fuzzy concepts

to capture requirements. Goals have to be analyzed by taking into account the dependencies amongst the actors.

Boness et al. [6] claimed that dependency could be expressed in a goal graph using the operationalizing elements that might not be dependable to the goals. This is due to impracticability or absence of requirements. Boness et al. [6] proposed stakeholder's confidence factors in order to evaluate the goal modeling. In another study by Cailliau and Van Lamsweerde [8], obstacle analysis is used where an obstacle is defined as a prerequisite for non-satisfaction of the goal. Obstacle analysis consists of (i) identifying obstacles in goals, assumptions and domain properties, (ii) assessing their likelihood and criticality and (iii) resolving likely and critical obstacles. This obstacle analysis is absolutely derived from the requirements of the stakeholders. On the other hand, Shukla and Auriol [9] used the comprehensive requirements modeling language (CReML) to form the goal modeling. They considered stakeholder's requirements and system artefacts in their formation of goal modeling.

Ultimately, the implementation of goals is seen to have substantial potential in aiding the elicitation and elaboration of requirements. Many researchers used goals as an essential model to represent the requirements specifications. Identifying goals precede either from: (i) top-down, (ii) bottom-up and (iii) non-directional approaches; higher-level (business or strategically) goals and lower-level (system requirements) based on each goal is either a root or sub goal is justified by how each objective is to be satisfied. However, based on Table 1, none of the researchers presented the goal model that includes all three elements which are stakeholder's goal together with the role and data integration. Thus, based on this gap, this study is motivated to demonstrate the element of stakeholder's role and data-dependent in the goal modeling formation. This study found that stakeholder role oriented identification in each of goal is crucial since multi-stakeholder role engagement has been seen as a risk factor for project success. Furthermore, this study also found that element of data-dependent exist when different stakeholders might be shared or contributed to a similar goal. Hence, the conflict may be exist, and the priority is needed to marginalize the complexity of data-dependent.

Table 1: Summary of Current Works in Goal Modeling

Methodology	Goal Model	Representative Elements		
		Stakeholder's goal	Stakeholder's role	Data
KAOS-based method	Goal Sketching [6] [12]	X	X	√
GORE-based method	CReML [9]	√	X	X
Fuzzy-based method	Subramanian et al. [7]	X	X	√
Other	Obstacle Analysis (Cailliau and Van Lamsweerde [8])	√	X	X

3. DATA-DEPENDENT ROLE-BASED GOAL MODELING

The goal realization graph is the initial stage of goal modeling that describes the system features or system component in the abstract level. This goal realization graph also focuses on the operationalization of process desired by multi stakeholders. The hierarchy of high level goals may involve key business processes that are required to be accomplished by multi stakeholders. The identified goals guide the subsequent activities that influence the decisions to be taken during the requirement refinement. Goal graph allows hierarchical decompositions of goals. The goal realization graph uses a goal-graph as a fundamental framework that performs the KAOS [10], [11] approach, in which the requirements or objectives that need to be accomplished by the stakeholders are stated by Bonnes et al. . Figure 2 illustrates the representation of goal realization graph used in this study in a top-bottom manner. The main root of the goal represents the hard goal to be achieved by the system. Next, the goals are refined into sub-goals that elaborate on how the main root goal is accomplished. The sub-goals are identified together with labeling its stakeholder role that is able to show the importance and commitment of each stakeholder.

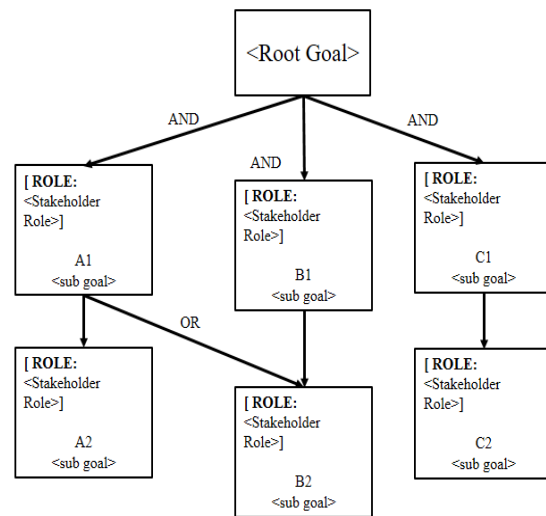
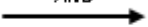



Figure 2: A goal realization graph

Meanwhile, Table 2 summarizes the notation used in developing the goal realization graph. In order to draw the goal realization graph, the following steps are required:

- i) Set the most abstract hard goal as the main root goal.
- ii) Extend with the sub-goal together with its stakeholder's role: the process of subdividing into a set of goals that represent the desired system solutions and alternatives to satisfy the main root goal.
- iii) Assign AND/OR refinement: expressing the relationship between the higher level and the lower level text.

Table 2: Notation of Goal Realization Graph

Notation	Description
<Root Goal>	<ul style="list-style-type: none"> A root goal to be achieved by the stakeholders
<div style="border: 1px solid black; padding: 5px; width: fit-content;"> [ROLE: <Stakeholder Role> Ai <sub goal> </div>	<ul style="list-style-type: none"> [ROLE: <Stakeholder Role>] Represents the stakeholder's role that executes the goal <sub goal> refers to the name of sub goal (Ai) shows the sequence number of goals
AND 	<ul style="list-style-type: none"> AND represents the relationship that the lower sub goal MUST be executed by stakeholder in order to satisfy the higher goal/sub goal
OR 	<ul style="list-style-type: none"> OR represents the relationship that the lower goal is OPTIONAL to be executed by the stakeholder in order to satisfy the higher goal/sub goal

well as the utilization for the development of system-to-be. Figure 3 illustrates the representation of goal realization graph that has been escalated towards the root to the leaves. The data element is included to the respective goal to make it more sufficiently concrete in order to ensure the satisfied performance of the system-to-be. Furthermore, Table 3 depicts the extended notation used in developing the goal realization graph. There are two additional steps involved to draw the goal realization graph:

- i) Identify goal's data element (if any): the process of identifying the related data element that might attach in a set of goals.
- ii) Determine inflow and output of each data element.

3.2 Assessment

The purpose of the goals assessment is to appraise what confidence the stakeholders might attach in the analysis expressed in the goal realization graph.

3.1 Integrated Data Element in Role-Based Goal Modeling

The uncertain distinction between data and stakeholder's goal might impair the combination as

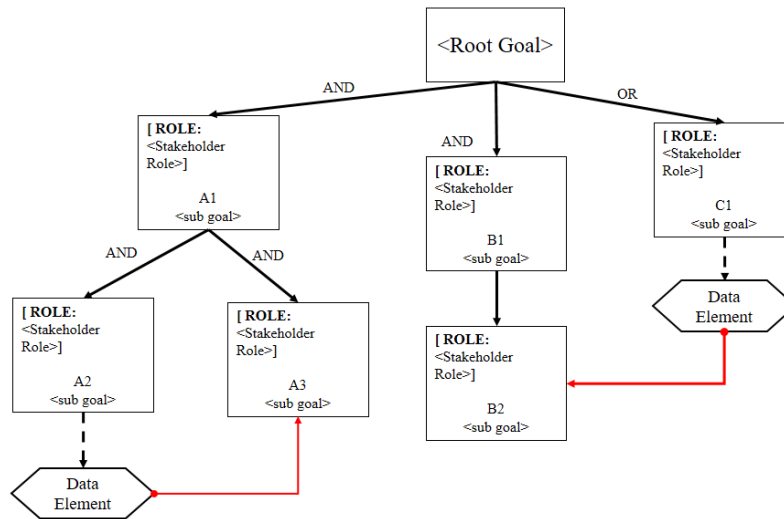
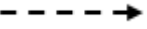

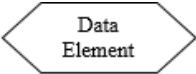

Figure 3: A goal realization graph with data element

Table 3: Additional notation of data-dependent Role-based goal realization graph

Notation	Description
	<ul style="list-style-type: none"> Illustrates the source/outflow of the data element information
	<ul style="list-style-type: none"> Illustrates the receiver/output of the data element information
	<ul style="list-style-type: none"> Represents the element attached in a set of goals that will make the goals more reliable to be realized

The focus is to assess stakeholders' representation based on the ROLE involved in the system-to-be. Therefore, four confidence factors are adopted from [6], [12] which are: (i) assumptions (ASSUME), (ii) achievability (ACHIEVE), (iii) stakeholder's mandate (MANDATE) and (iv) refinement (REFINE). This study requires an expert's rating of the confidence factors in order to obtain the feasibility and the adequacy attached for each goal. Besides, the assessment of data-element in role-based realization graph is to determine the level of confidence factor together with the complexity of data that might attach in a set of sub goal expressed in the goal realization graph. Later, to estimate the complexity of data element, this study presents metric of DATA.

The definition of the selected confidence factors is summarized in Table 4. Each sub goal will be assigned with the confidence factor either ASSUME or ACHIEVE and must be assigned with MANDATE and REFINE. Once each sub goal has been assigned with the confidence factors, each of them will be rated by expert using 4-point ordinal scale (NONE, LOW, MEDIUM and HIGH) as tabulated in Table 5. This rating technique was adopted from Boness et al. [6]. The default rating for each confidence factor is LOW.

Table 4: Definition of confidence factor [6]

Notation	Description
ASSUME	<ul style="list-style-type: none"> The sub goal and its environment are trusted and satisfied despite the stakeholder has inadequate grounds for believing this as reliable

ACHIEVE	<ul style="list-style-type: none"> The acceptance criteria of the sub goal is achievable despite the stakeholder has inadequate grounds for believing the implementation as feasible
MANDATE	<ul style="list-style-type: none"> The sub goal is trusted and satisfied to have adequate scrutiny from the stakeholder.
REFINE	<ul style="list-style-type: none"> The sub goal is still uncertain and incomplete, which is open for refinement from the stakeholder.

Table 5: 4-point ordinal scale rating [6]

Notation	Description	Abbreviation
NONE	<ul style="list-style-type: none"> There is a known fact that suggests the confidence factor defined for the sub goal is unsound 	N
LOW	<ul style="list-style-type: none"> The confidence factor defined for the sub goal is questionable, or the information is too fragmented or poorly corroborated to make the goal more concrete 	L
MEDIUM	<ul style="list-style-type: none"> The confidence factor defined for the sub goal is believable but not yet sufficiently justified to assure a higher level of rating. 	M
HIGH	<ul style="list-style-type: none"> The confidence factor defined for the sub goal is based on high-quality information, and/or the environment of the confidence factor makes it a sufficiently concrete judgment. 	H

3.3 Feasibility and Adequacy to Identify the Risk

According to Boness et al. [6], assessing the work or task is essential during requirements analysis, whether it is feasible and adequate to be implemented. ASSUME and ACHIEVE confidence factors are used to estimate the feasibility of each sub goal in the goal realization graph. Meanwhile MANDATE and REFINE confidence factors are used to determine the degree of adequacy of each sub goal in the goal realization graph.

As illustrated in Figure 4, the feasibility (FEASIBLE) assessment is based on the weakest link technique that propagates the goal towards the root from the leaves. The FEASIBLE is then determined using both the ASSUME and ACHIEVE ratings. For instance, if the lowest sub goal ASSUME = HIGH, ACHIEVE = MEDIUM, then the upper sub goal is determined as FEASIBLE = MEDIUM, may complement using the following rules:

- a. If the lower sub goal has ASSUME = LOW and ACHIEVE = HIGH then the upper sub goal/root goal has FEASIBLE = LOW.
- b. If the lower sub goal has ASSUME = HIGH and ACHIEVE = MEDIUM, then the upper sub goal/root goal has FEASIBLE = MEDIUM.
- c. If the lower sub goal has ASSUME = HIGH and ACHIEVE = HIGH, then the upper sub goal/root goal has FEASIBLE = HIGH.

In Figure 5, the adequacy (ADEQUATE) assessment is calculated based on parent goal (root) towards their leaves. In Boness et al. [6], ADEQUATE assessment cannot be based on the combination of one single REFINE rating and one single MANDATE and should traverse from the root towards the leaves with the assumption of a possible lack of confidence in the ratings of REFINE and MANDATE. In this study, each of the sub goal has been given value of REFINE and MANDATE by the expert using value of NONE, LOW, MEDIUM and HIGH. Subsequently, each sub goal is given a rating based on REFINE and MANDATE profile matrix as tabulated in Table 6. For example, if the lowest sub goal REFINE = HIGH, MANDATE = MEDIUM, then the upper

sub goal is determined as RA = MEDIUM.

Table 6: REFINE and MANDATE profile matrix [2]

MANDATE	H	N	L	M	H
	M	N	L	L	M
	L	N	L	M	M
	N	N	N	N	N
		N	L	M	H
		REFINE			

Key: N: NONE; L: LOW; M: MEDIUM; H: High

Once the FEASIBLE and ADEQUATE ratings have been propagated through the goal realization graph, the risk of each sub goal is identified. According to Boness et al. [6], the higher the fraction of sub goals in the PROCEED zone, the lower is the risk in the requirement of the project. The CAUTION zone might be a cause of great concern due to the inadequacy or unfeasibility of the sub goal to be implemented. A higher number of leaf goals in the DO NOT PROCEED zone might indicate that further requirements work is required by the requirement engineer to get more information about the mandate and to re-examine the requirements. Table 7 shows the risk identification as a result of value of FEASIBLE and ADEQUATE in the goal realization graph.

3.4 Conflict and Priority to Identify Complexity

DATA indicates the sub goal comprises of data element that contributes to other sub goals to have adequate grounds to be implemented. In role-based goal realization graph, the data element typically will be placed at the last node of the sub goal that will be connected to other sub goals. This is because the sub goal shares and requires the similar information from the data element.

Table 7: The risk identification based on FEASIBLE and ADEQUATE [6]

ADEQUATE	H				
	M				
	L				
	N				
		N	L	M	H
		FEASIBLE			

Key:

- PROCEED
 $(ADEQUATE = M \vee H) \wedge (FEASIBLE = M \vee H)$
- CAUTION
 $((ADEQUATE = L) \wedge (FEASIBLE = M \vee H)) \vee ((FEASIBLE = L) \wedge (ADEQUATE = M \vee H))$
- DO NOT PROCEED
 $(ADEQUATE = N \vee L) \wedge (FEASIBLE = N \vee L)$

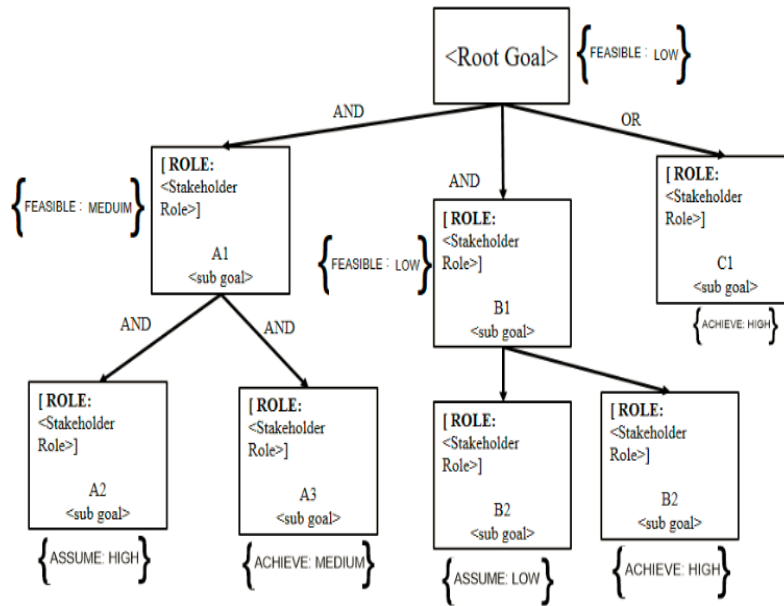

Figure 4: The determination of FEASIBLE

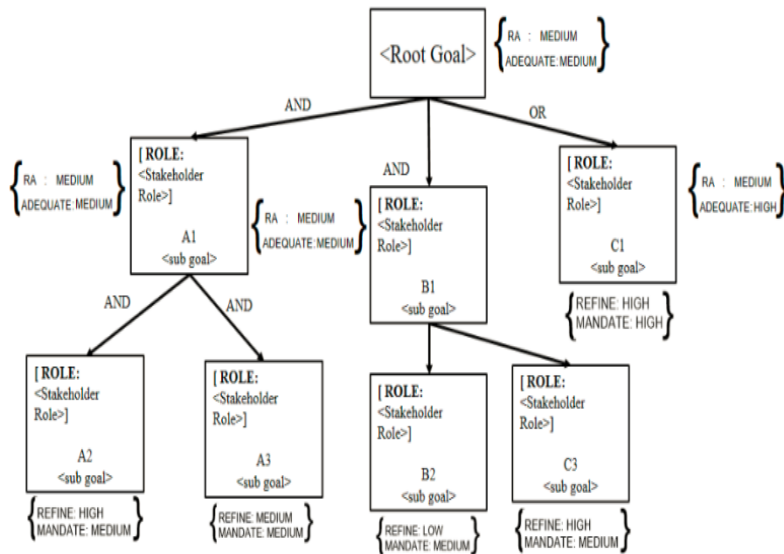

Figure 5: The determination of ADEQUATE

Besides, this study considers the type of DATA inflow and outflow that could be occurred in role-based goal realization graph. Each DATA presents the different complexity that might arise which is tabulated in Table 8.

The complexity (COMPLEX) of DATA will be assessed based on the rating of conflict (CONF) and priority (PRIOR) of the data element. The number of ROLE that might attach to the DATA

will be estimated in order to find the degree of the DATA complexity. CONF of data element describes the number of ROLE which gives the requirements to the sub goal that needs DATA to be implemented whereas PRIOR shows that the ROLE requires the DATA to proceed with the system function. The DATA will be rated by the expert using the 4-point ordinal scale. Each DATA is given a rating based on CONF and PRIOR profile matrix as tabulated in Table 9.

Table 8: Type of DATA inflow and outflow

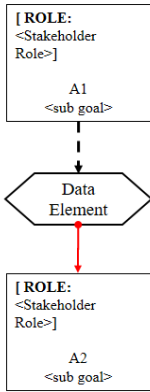
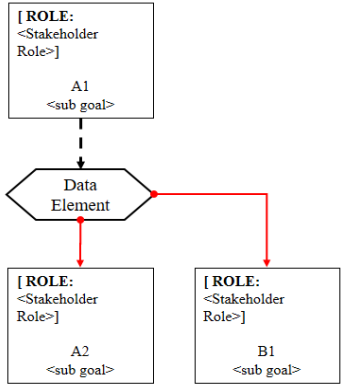
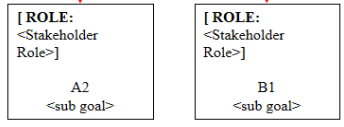
Type	COMPLEX	
	CONF	PRIOR
	<ul style="list-style-type: none"> • Inflow : L/M • Outflow : M/H • CONF = M 	<ul style="list-style-type: none"> • Inflow : L/M • Outflow : M/H • PRIOR = M
	<ul style="list-style-type: none"> • Inflow : L/M • Outflow : H • CONF = H 	<ul style="list-style-type: none"> • Inflow : L/M • Outflow : M/H • PRIOR = H
	<ul style="list-style-type: none"> • Inflow : H/M • Outflow : L/M • CONF = M 	<ul style="list-style-type: none"> • Inflow : H/M • Outflow : M • PRIOR = M

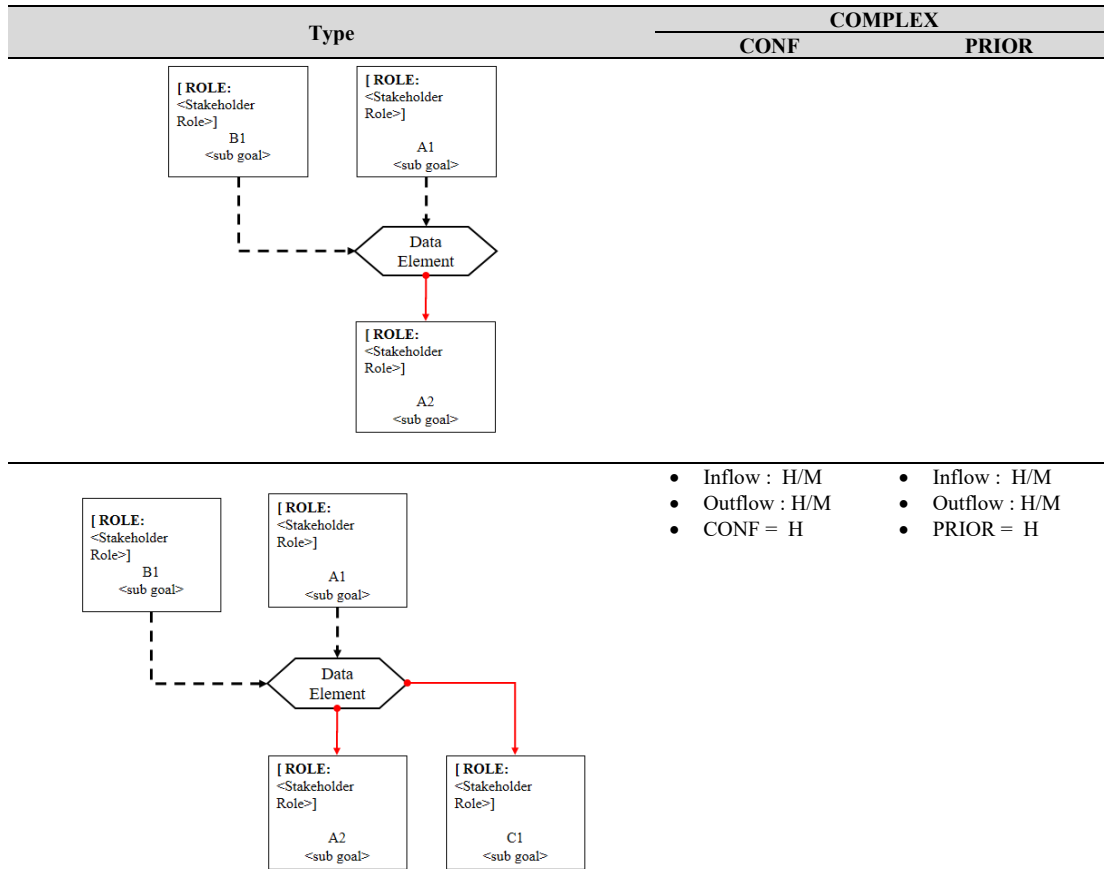

Key: N: NONE; L: LOW; M: MEDIUM; H: HIGH

Table 9: CONF and PRIOR profile matrix to identify data complexity

CONF	H	N	L	M	H
	M	N	L	L	M
	L	N	L	M	M
	N	N	N	N	N
		N	L	M	H
		PRIOR			

Key: N: NONE; L: LOW; M: MEDIUM; H: HIGH

4. IMPLEMENTATION OF THE CASE STUDY

In Plantation Integrated System (PIS), the labour module has been specifically selected as a case study in order to validate our proposed goal modeling. Selected labour module involves multi

stakeholders since it has been deployed in three different level of operations which are headquarters (HQ), region and branch. Figure 6 demonstrates a segment of business workflow in managing labour requisition. There are five direct stakeholders (those who use the system) identified. Each role has their own goal in realizing the process of labour

requisition. From this business workflow, the goal of each stakeholder can be modelled. All stakeholders and processes in Figure 6 are extracted and transformed into goal realization graph as exemplified in Figure 2 using the formation guideline described in Section 3.

Figure 6: Business workflow of labour requisition

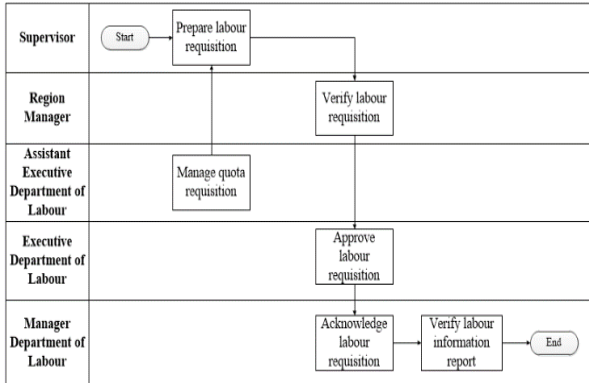

Figure 7 presents the detail level of goal realization graph for “Manage Labour Requisition”. To make the root goal more concrete, the goal is split into GOAL A1 and GOAL A2. GOAL A2 is refined into GOAL A2.1 and GOAL A2.1.1, which makes it more feasible to reach the root goal. Besides, GOAL A2.1.1 is made more sufficiently concrete by adding two more sub goals which are GOAL A2.1.1.1 and GOAL A2.1.1.2. For each sub goal, the role of stakeholder is attached.

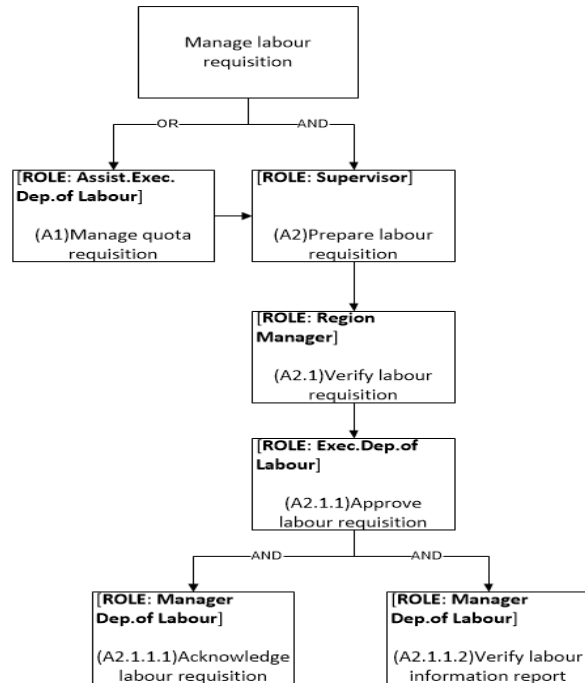

Figure 7: The role-based goal realization graph of labour requisition management

Next, the representation of role-based goal model can be enhanced with confidence factor ratings as illustrated in Figure 8.

Finally, the propagated FEASIBLE and ADEQUATE, the risk of each sub goal can be

identified as tabulated in Table 10. Table 10 indicates that there were five goals that demonstrated the PROCEED zone and two goals demonstrated the CAUTION zone. It shows that in goal “Manage labour requisition”, only minimum potential risks might attach to the requirement

stated by stakeholders. If there is appearance of risk prediction, requirement engineer could re-examine the requirement before it can be proceeded to other stages of development.

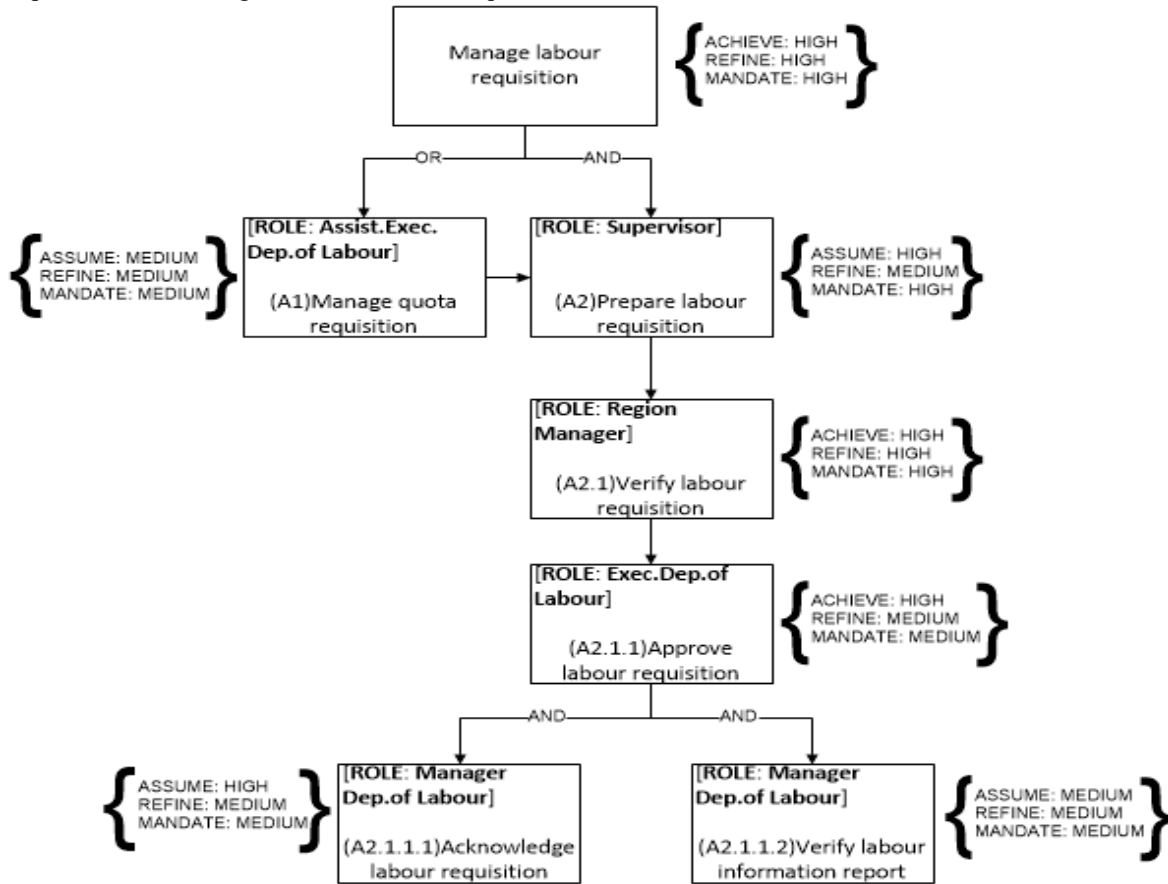

Figure 8: The role-based goal realization graph with confidence factor rating of labour requisition management

4.1 Extend with data dependency

Table 10: The goal count for role-based goal

ADEQUATE	H				1
	M				2
	L				
	N				
		N	L	M	H

FEASIBLE modeling in Figure 8

Key: N: NONE; L: LOW; M: MEDIUM; H: HIGH

Figure 9 demonstrates the detail level of role-based goal realization graph for “Manage Labour Requisition” together with their dependent functions which are “Manage Labour Status” and “Manage Labour Application”. GOAL C1.1 shows that the sub goals are associated to the sub goal A1 and A2. Therefore, GOAL A1 and GOAL A2 requires an information from GOAL C1.1 before it can be initiated. Besides, the information from GOAL A2.1.1 is essential for GOAL B1. Without the information from previous process, the next process would have inadequate information. As a result, there might be errors occurred during such process.

Figure 10 further demonstrates the example of DATA. The data element is associated with

“Manage Labour Requisition” and “Manage Labour Application”. In order to make GOAL A2.1.1 more concrete, the data element is required so that GOAL B1 can be initiated. The DATA attached to the sub goal is “Requisition form”. The “Requisition form” consists of requisition details filled up by the Executive Department of Labour. GOAL A2.1.1 provides the information of the DATA which will initiate the process of managing labour application.

GOAL B1 will receive the information sent from the DATA that contains the information details of requisition labour. The ROLE in GOAL B1 will prepare the labour application according to the information stated in the DATA. Once the DATA have been identified, the expert will rate each sub goal and the data element using the confidence factors as described in Section IV.

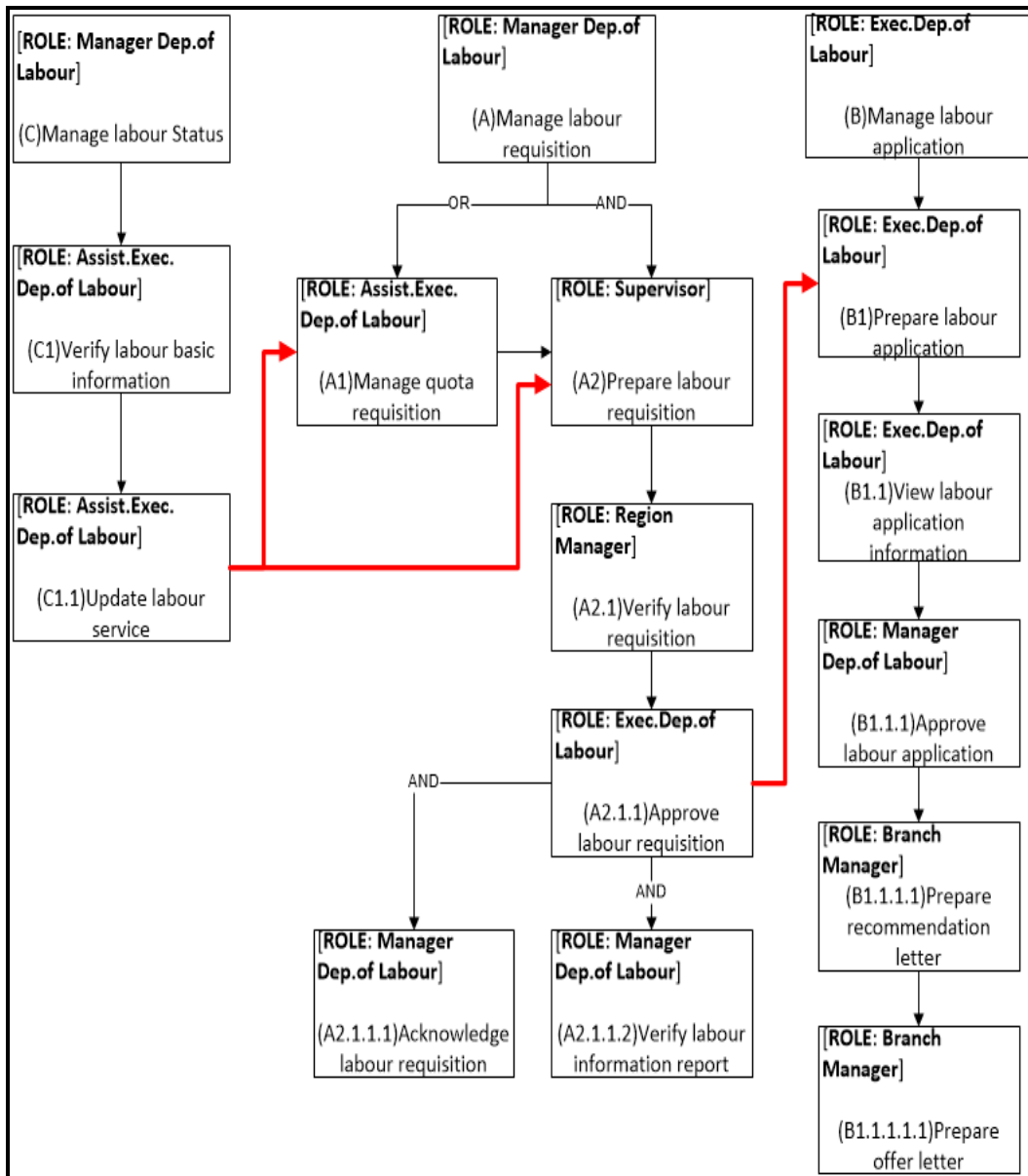

Figure 9: Interrelation between “Manage Labour Requisition” and other functions

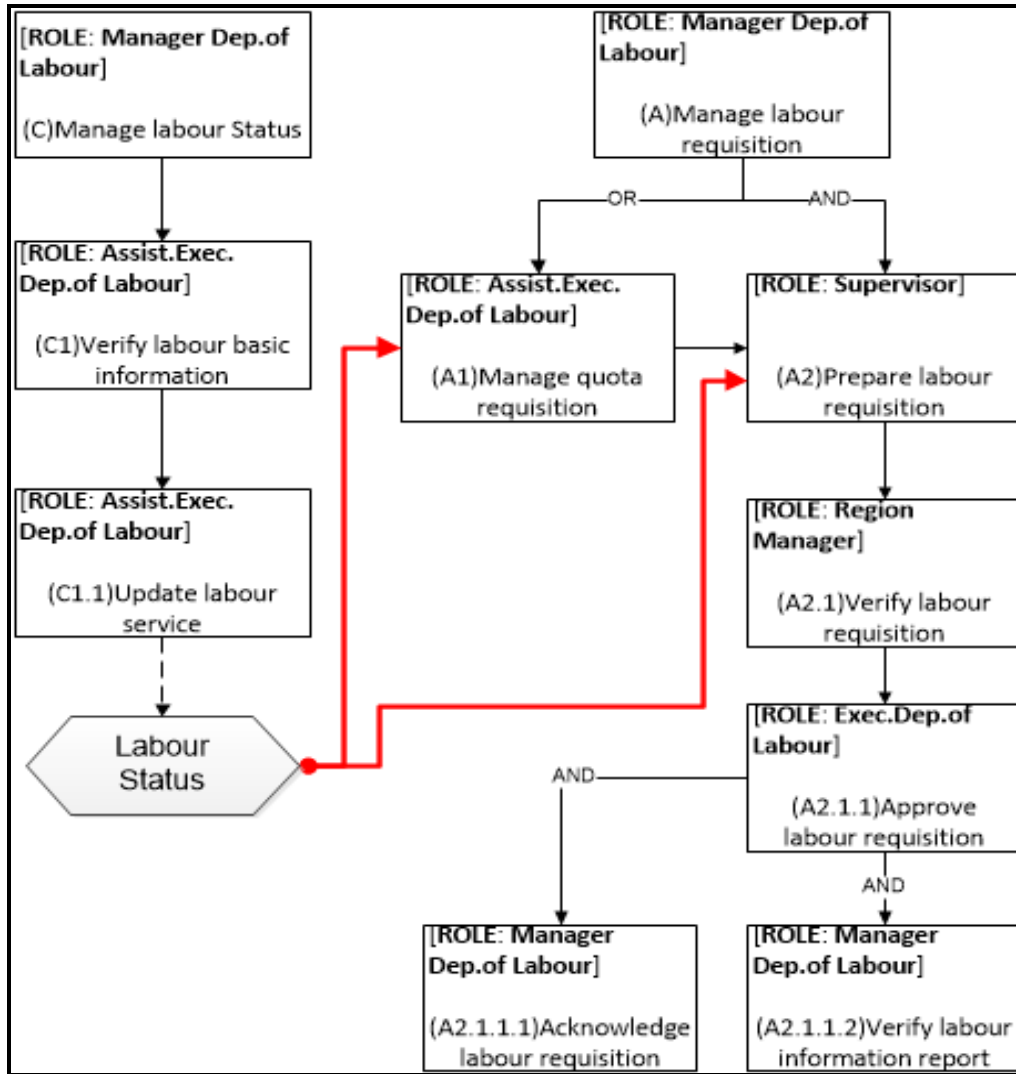

Figure 2: Interrelation between “Manage Labour Requisition” and “Manage Labour Status

5. DISCUSSION

Data-dependent role-based goal modeling has extended the design of goal modeling that proposed by Boness et al. [6]. The new enhanced goal modeling highlights two new elements in goal graph representation which are stakeholder’s role and data element. Hence, the assessment of each goal is then influenced by the risk of stakeholder’s role and the complexity of integrated data.

In this study, the importance of the inflow and outflow of each data element is considered based on the ROLE of the stakeholders. The higher the portion of the goals that falls under the COMPLEX zone, the higher are the chances of risk to the

project. It will cause greater concern for the requirement analyst to assess the inadequate requirements in the project [6]. Figure 11 presents the example of data element exist between different stakeholder’s roles, while Figure 12 represents the rating of COMPLEX for the data element.

As a result, the DATA showed the CONF is rated as MEDIUM because the requisition will be processed only when ROLE in GOAL A2.1.1 approves the requisition application. If the application is rejected, there will be no labour application to be done. The PRIOR is rated as HIGH due to the ROLE who receives the information, as it will set out the preparation of labour application. The higher the proportion of the goals fell in the COMPLEX zone, the higher are the

chances of risk arouse to the project. It will cause a greater concern to the requirement analyst to assess the inadequate or infeasible requirement in the project.

Finally, the risk of each sub goal can be identified as tabulated in Table 11. Table 11 indicates that the complexity of the data element is

HIGH and the risk fall in the PROCEED zone. It shows that the appearance of risk is minimum, therefore the requirements is feasible and adequate to be implemented. In addition, the association between the data element is necessary and must be displayed during the analysis phase, so that the requirement engineer may explain to the developer before proceeding with the design phase.

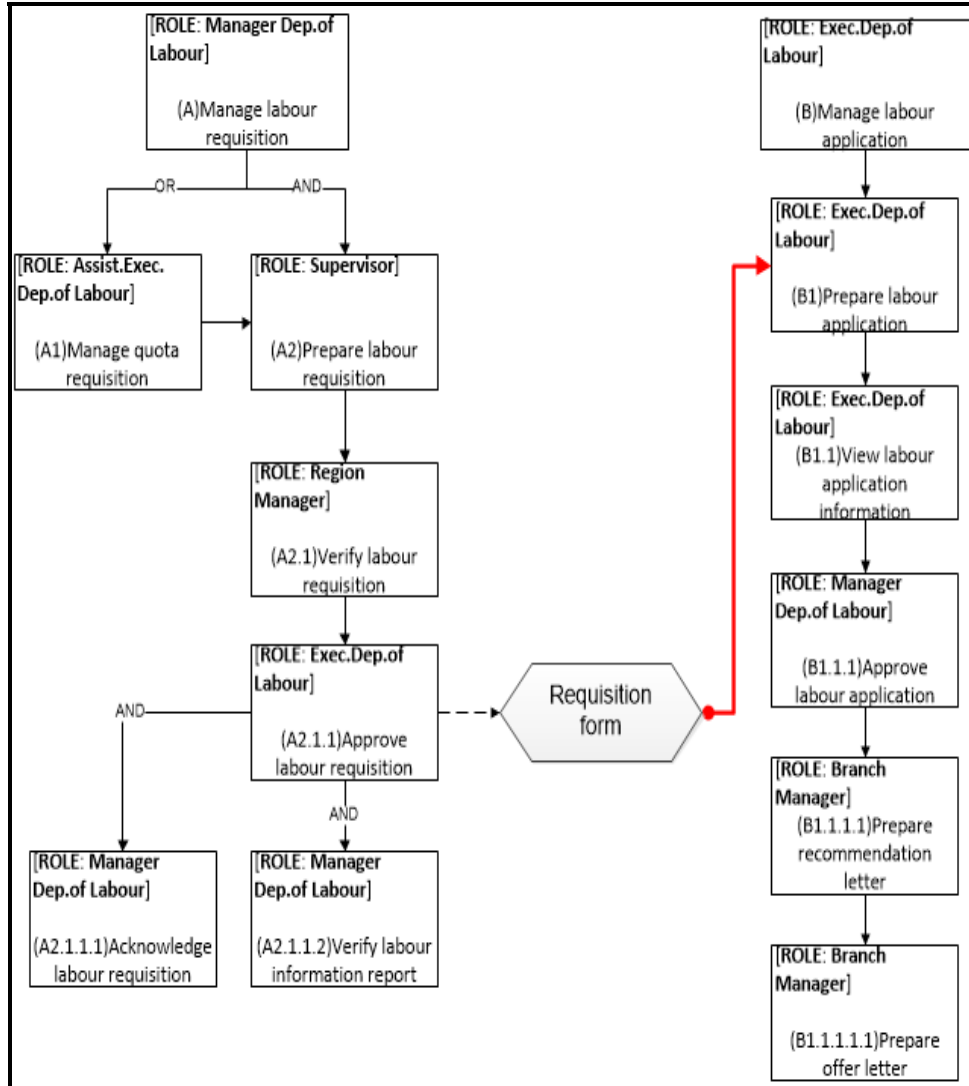

Figure 3: Interrelation between “Manage Labour Requisition” and “Manage Labour Application”

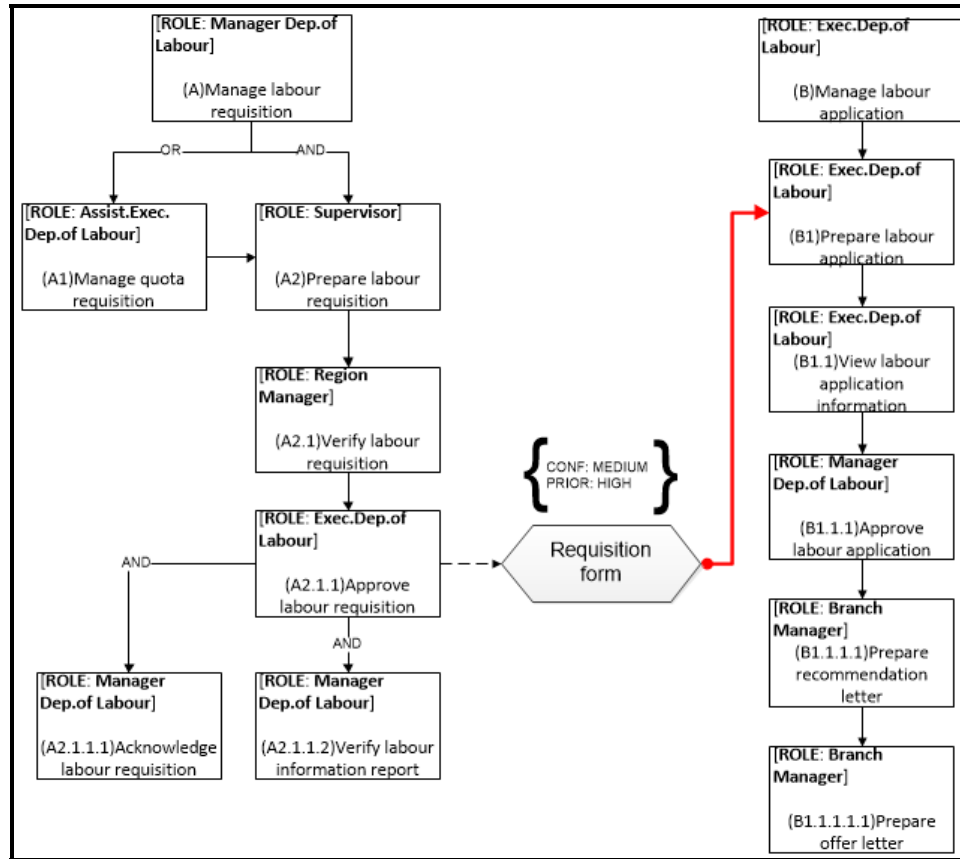

Figure 4: Rating for Interrelation between “Manage Labour Requisition” and “Manage Labour Application”

Table 11: The risk and complexity assessment

ROLE		RISK		COMPLEX
R_i	R_{i+1}	D	C	
/	/	PROCEED	2	NONE
/		CAUTION	2	NONE
/		PROCEED	2	NONE
/		PROCEED	2	NONE
/		PROCEED	1	HIGH
/		PROCEED	1	NONE
/	/	CAUTION	2	NONE

Key: N: NONE; L: LOW; M: MEDIUM; H: HIGH; D: Degree; C: Count, / - Stakeholder with respective role contribute requirements

6. CONCLUSION

In summary, this paper has demonstrated the data element that has an important impact in goal modeling. Apart from stakeholder’s role, data element potential to show the complexity of goal modeling by identifying any conflict and prioritization factors from multi stakeholders. The result obtained from this study shows, even though the requirements are adequate and minimum risk,

yet the goal is still complex due to data conflict is occurred and the priority is high. Thus, this study has attempted to show another evaluation method that can be used to analyze the goals and requirements of software project.

Future work is necessary to provide further validation by comparing the results with other similar works and to determine the application domains to which this method is best suited.

ACKNOWLEDGEMENTS

This research was supported by the MyBrain scholarship scheme of the Ministry of Higher Education Malaysia and the G-Heart scheme under the Gates Scholars Foundation. Also thanks to publication fund by Vot No: 4F973, 4C097, 11H84 and 4C073 as well as to RMC UTM.

REFERENCES:

- [1] Huysegoms, T., Snoeck, M., Dedene, G., Goderis, A., and Stumpe, F., “Visualizing Variability Management in Requirements Engineering through Formal Concept Analysis,” *Procedia Technology*, Vol. 9, No. 1, Jan. 2013, pp. 189–199.
- [2] Bai, X., Huang, L., and Zhang, H., “On Scoping Stakeholders and Artifacts in Software Proces New Modeling Concepts for Today’s Software Processes,” in *Proceedings of 2010 International Conference on Software Process (ICSP 2010)*, 2010, Vol. 6195, pp. 39–51.
- [3] Pohl, K. and Klaus, “PRO-ART: A process centered requirements engineering environment,” in *Matthias Jarke, Colette Rolland, Alistair Sutcliffe (eds.): The NATURE of Requirements Engineering*, Shaker, Aachen, Research Studies Press, 1996, p. 342.
- [4] Carlshamre, P., Sandahl, K., Lindvall, M., Regnell, B., and Natt och Dag, J., “An Industrial Survey of Requirements Interdependencies in Software Product Release Planning,” in *Proceedings of the 5th IEEE International Symposium on Requirements Engineering*, 2001, Vol. 1, pp. 84–91.
- [5] Aamodt, A. and Nygard, M., “Different Roles and Mutual Dependencies of Data, Information, and Knowledge - An AI Perspective on their Integration,” *Data Knowledge Engineering*, Vol. 16, No. 3, Sep. 1995, pp. 191–222.
- [6] Boness, K., Finkelstein, A., and Harrison, R., “A Method for Assessing Confidence in Requirements Analysis,” *Inf. Software Technology*, Vol. 53, No. 10, Oct. 2011, pp. 1084–1096.
- [7] C. M. Subramanian, A. Krishna, and A. Kaur, “Reasoning about Goal Satisfaction for Early Requirements Engineering in the i*Framework using Inter-Actor Dependency,” in *Proceedings of Pacific Asia Conference on Information Systems (PACIS)*, 2015, pp. 89.
- [8] Cailliau, A. and Van Lamsweerde, A., “Integrating Exception Handling in Goal Models,” in *2014 IEEE 22nd International Requirements Engineering Conference, RE 2014 - Proceedings*, 2014, pp. 43–52.
- [9] Shukla, V. and Auriol, G., “Reinventing Goal-Based Requirements Modeling,” in *Proceeding of the Posters Workshop of Complex Systems Design & Management Conference CSD&M 2013*, 2013.
- [10] Almisned, F. and Keppens, J., “Requirements Analysis: Evaluating KAOS Models,” *J. Software Engineering. Application*, Vol. 3, 2010, pp. 869–874.
- [11] Van Lamsweerde, A., “Goal-oriented Requirements Engineering: A Guided Tour,” in *Proceedings of the 5th IEEE International Symposium on Requirements Engineering*, 2001, pp. 249–262.
- [12] Boness, K., Finkelstein, A., and Harrison, R., “A Lightweight Technique for Assessing Risks in Requirements Analysis,” *IET Software*, Vol. 2, No. 1, pp. 46–57, 2008.