

Modelling and Force Tracking Control of Hydraulic Actuator for an Active Suspension System

Y. M. Sam and K. Hudha

Faculty of Electrical Engineering,
Malaysia University of Technology,
81310 Skudai, Johor - Malaysia
Email: yahaya@fke.utm.my

Abstract

This paper presents modelling and force tracking control of a non-linear hydraulic actuator applied in a quarter-car active suspension system. The controller structure of the active suspension system was decomposed into two loops namely outer loop and inner loop controllers. Outer loop controller is used to calculate the optimum target force to reject the effects of road disturbances, while, the inner loop controller is used to keep the actual force close to this desired force. The results of the study show that the inner loop controller is able to track well the target force ranging from sinusoidal to random functions of target force. The performance of outer loop controller also shows significant improvement in terms of body acceleration, body displacement and suspension displacement as compared to the passive suspension system.

1 Introduction

Active Suspensions systems have been widely studied over the last 30 years, with hundreds of papers published [1]. Most of the published works focus on the outer-loop controller in computation of the desired control force as a function of vehicle states and the road disturbance [2]. It is commonly assumed that the hydraulic actuator is an ideal force generator and able to carry out the commanded force accurately. Simulations of these outer-loop controllers were frequently done without considering actuator dynamics, or with highly simplified hydraulic actuator dynamics.

In real implementation, actuator dynamics can be quite complicated, and the interaction between the actuator and the vehicle suspension cannot be ignored. It is also difficult to produce the actuator force close to the target force without implementing inner-loop or force tracking controller. This is due to the fact that hydraulic actuator exhibits non-linear behavior resulted from servo-valve dynamics, residual structural damping, and the unwanted effects of back-pressure due to the interaction between the hydraulic actuator and vehicle suspension system. A few previous works on the force tracking controller of hydraulic actuator can be found on [2], [3], [4] and [5].

This study focuses on the development of a non-linear hydraulic actuator model including its force tracking controller for an active suspension system. The

non-linear hydraulic actuator model consists of servo-valve dynamics and the interaction of piston-cylinder. Force tracking control of the hydraulic actuator model is then performed using Proportional Integral (PI) controller for a variety of the functions of target forces namely step, sinusoidal, saw-tooth, square and random functions.

Once the inner loop controller of hydraulic actuator is able to track well the target forces with acceptable error, the hydraulic actuator model and the inner loop controller are then integrated with the outer loop of active suspension control. In this configuration, the inner loop controller must be able to track the optimum target force of hydraulic actuator calculated by the outer loop controller. The actual force of hydraulic actuator is inserted to the vehicle model to reject the effects of road disturbance to the vehicle dynamics performances. For outer loop controller, modified hybrid skyhook groundhook controller is considered [6], [7],[8].

This paper is organized as follows: the first section contains introduction, the second section describes the equations of motion of the hydraulic actuator model, the third section presents force tracking control of the hydraulic actuator model, the fourth section elaborates the disturbance rejection control of the active suspension system and the last section presents some conclusions.

2 Hydraulic Actuator Model

A complete set of a hydraulic actuator consists of five main components namely electro hydraulic powered spool valve, piston-cylinder, hydraulic pump, reservoir and piping system as shown in Figure 1. Power supply is needed to drive the hydraulic pump through AC motor and to control the spool valve position. The hydraulic pump will keep the supply pressure at the optimum level of about 20,684 kN/m². The spool valve position will control the fluid to come-in or come-out to the piston-cylinder which determines the amount of force produced by the hydraulic actuator.

The hydraulic actuators are governed by electro hydraulic servo valve allowing for the generation of forces between the sprung and unsprung masses. The electro hydraulic system consists of an actuator, a primary power spool valve and a secondary bypass valve. As seen in Figure 2, the hydraulic actuator

cylinder lies in a follower configuration to a critically centered electro hydraulic power spool valve with matched and symmetric orifices. Positioning of the spool u_1 directs high pressure fluid flow to either one of the cylinder chambers and connects the other chamber to the pump reservoir. This flow creates a pressure difference P_L across the piston. This pressure difference multiplied by the piston area A_p is what provides the active force F_A for the suspension system.

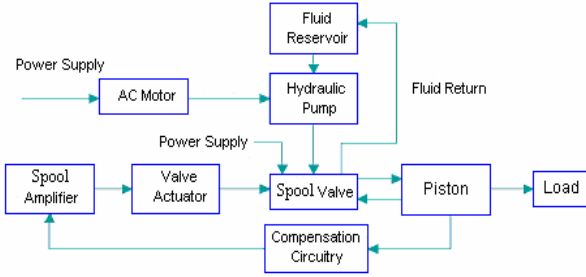

Figure 1: Diagram of a complete set of hydraulic actuator.

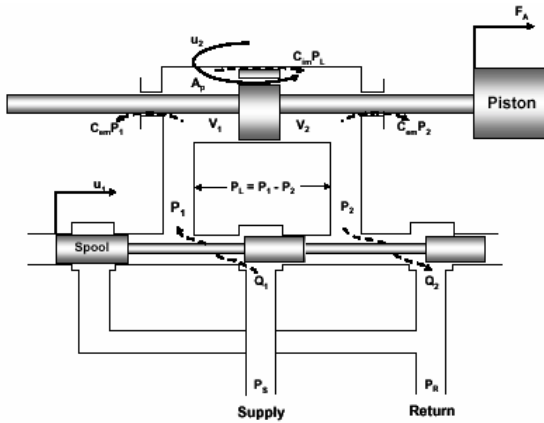

Figure 2: Physical schematic and variables for the hydraulic actuator.

Dynamics for the hydraulic actuator valve are given as the followings: the change in force is proportional to the position of the spool with respect to center, the relative velocity of the piston, and the leakage through the piston seals. A second input u_2 may be used to bypass the piston component by connecting the piston chambers.

$$\dot{F}_A = A_p \alpha \begin{bmatrix} C_{d1} w u_1 \sqrt{\frac{P_s - \text{sgn}(u_1) P_L}{\rho}} \\ C_{d2} u_2 \text{sgn}(P_L) \sqrt{\frac{2P_L}{\rho}} \\ C_{lm} P_L - A_p (\dot{x}_s - \dot{x}_u) \end{bmatrix} \quad (1)$$

The bypass valve u_2 could be used to reduce the energy consumed by the system. If the spool position u_1

is set to zero, the bypass valve and actuator will behave similar to a variable orifice damper. Spool valve positions u_1 and u_2 are controlled by a current-position feedback loop. The essential dynamics of the spool have been shown to resemble a first order system as the followings

$$\dot{u}_i + u = kv \quad (2)$$

3 Force Tracking Control of Hydraulic Actuator Model

The structure of force tracking control of hydraulic actuator is shown in Figure 3. The hydraulic actuator model take two input namely spool valve position and real time piston speed. Proportional Integral control is implemented which takes force tracking error as the input and delivers control current to drive the spool valve. The target force is represented by sinusoidal, square, saw-tooth and random functions. The parameters of hydraulic actuator model are taken from [9] as the followings: $A_p = 0.0044 \text{ m}^2$, $\alpha = 2.273 \times 10^9 \text{ N/m}^5$, $C_{d1} = 0.7$, $C_{d2} = 0.7$, $w = 0.008 \text{ m}$, $P_s = 20684 \text{ kN/m}^2$, $\rho = 3500$, $C_{lm} = 15 \times 10^{-12}$, $\tau = 0.001 \text{ sec}^{-1}$.

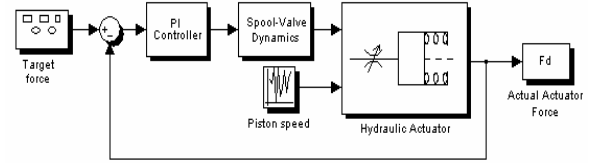

Figure 3: Force tracking control of hydraulic actuator

The force tracking error of the hydraulic actuator model using Proportional Integral controller for sinusoidal, square, saw-tooth and random functions of the target force are shown in Figures 4, 5, 6 and 7 respectively. This is to check the controllability of the force tracking controller for a class of continuous discontinuous functions. In this simulation study, the parameter of proportional gain P is set to 1.25 and for Integral gain I is set to 0.75. From these figures, it can be seen clearly that the hydraulic actuator model tracks the desired force well.

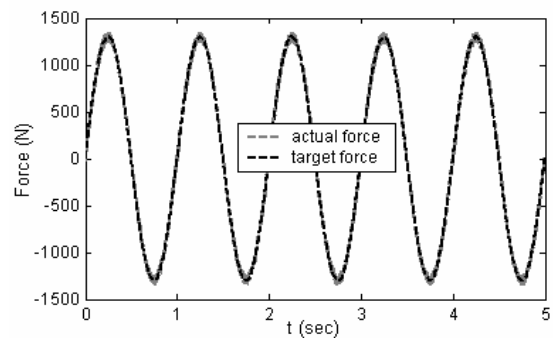

Figure 4: Force tracking performance for sinusoidal function of target force

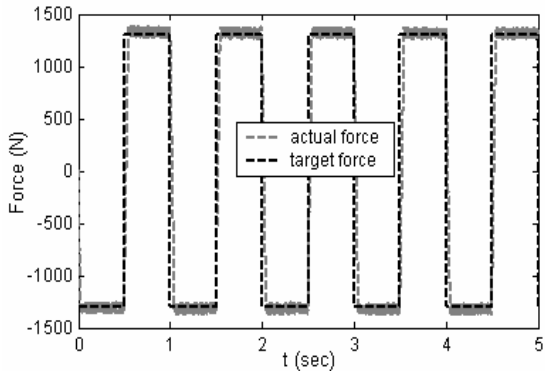

Figure 5: Force tracking performance for square function of target force

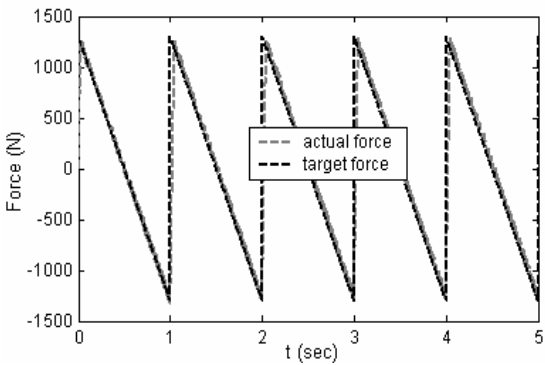

Figure 6: Force tracking performance for saw-tooth function of target force

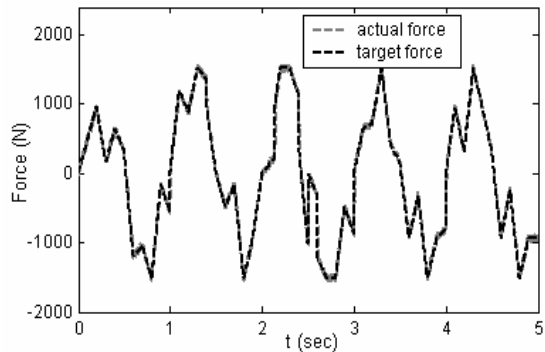

Figure 7: Force tracking performance for random function of target force

It is also noted that due to the rapid changes of force magnitude in the case of discontinuous function of target force such as saw-tooth and square functions, the performance of force tracking controller is slightly worse than that of continuous function of target force. This is caused by the response of the spool valve that fails to follow the target force without time delay particularly when the rapid change of force magnitude is occurred.

4 Disturbance Rejection Control of an Active Suspension System

4.1 Quarter Vehicle Model

The vehicle model considered in this study is a quarter car model. The quarter car model for passive suspension system consists of one-fourth of the body mass, suspension components and one wheel as shown in Figure 8 (a). The quarter car model for active suspension system, where the hydraulic actuator is installed in parallel with the spring, is shown in Figure 8 (b).

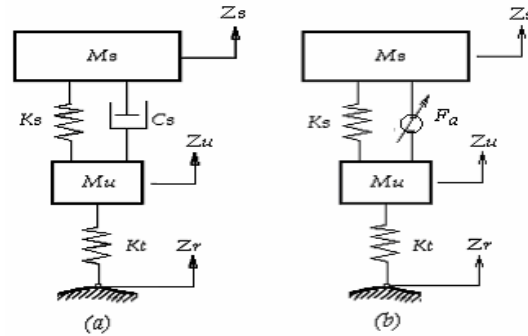

Figure 8: Passive and active quarter car model.

The assumptions of a quarter car modelling are as follows: the tyre is modelled as a linear spring without damping, there is no rotational motion in wheel and body, the behaviour of spring and damper are linear, the tyre is always in contact with the road surface and effect of friction is neglected so that the residual structural damping is not considered into vehicle modelling. The equations of motion for the sprung and unsprung masses of the passive quarter car model are given by

$$\begin{aligned} M_s \ddot{Z}_s + K_s(Z_s - Z_u) + C_s(\dot{Z}_s - \dot{Z}_u) &= 0 \\ M_u \ddot{Z}_u + K_t(Z_u - Z_r) + K_s(Z_u - Z_s) + \\ C_s(\dot{Z}_u - \dot{Z}_s) &= 0 \end{aligned} \quad (3)$$

Whereas, the equations of motion for the sprung and unsprung masses of the semi-active quarter-car model are given by

$$\begin{aligned} M_u \ddot{Z}_u + K_t(Z_u - Z_r) + K_s(Z_u - Z_s) - F_a &= 0 \\ M_s \ddot{Z}_s + K_s(Z_s - Z_u) + F_a &= 0 \end{aligned} \quad (4)$$

where,

- M_s = sprung mass
- K_s = spring stiffness
- M_u = unsprung mass
- C_s = damping constant
- Z_r = road profile

- K_t = tyre stiffness
 Z_u = unsprung mass displacement
 Z_s = sprung mass displacement
 F_a = actuator force

Due to the tyre stiffness, vertical force acting on the contact point between tyre and the road will be created when the tyre hits a certain road profile. Then, the vertical force is transferred to the wheel resulting in vertical acceleration of the wheel. Part of the vertical force is damped out by the suspension elements, whereas, the rest is transferred to the vehicle body via the suspension elements. The vehicle body will move vertically in response to the vertical force of the suspension elements. The performance criteria of the suspension system to be investigated in this study are body acceleration (\ddot{Z}_s), body displacement (Z_s), suspension working space ($Z_u - Z_s$) and wheel displacement (Z_u). Performance of the suspension system is characterized by the ability of the suspension system in reducing those four performance criteria effectively.

4.2 Controller Structure

Basically, the controller structure of an electronically controlled suspension system utilizes two controller loops namely outer loop and inner loop controllers which corresponds to vehicle controller and actuator controller. The similar terms, which is often used for outer and inner loop controllers, are global and local controllers. The controller structure was used for an active suspension system in [4] and [5]. The similar controller structure was used for semi-active suspension control by Sims *et al.* (1999), Lai and Liao (2002a; 2002b).

The controller structure adopted in this study is shown in Figure 9. The outer loop controller is used for disturbance rejection control to reduce unwanted vehicle's motions. The inputs of the outer loop controller are vehicle's states namely body velocity and wheel velocity, whereas the output of the outer loop controller is the target force that must be tracked by the hydraulic actuator. On the other hand, the inner loop controller is used for force tracking control of the hydraulic actuator in such a way that the force produced by the hydraulic actuator is as close as possible with the target force produced by the disturbance rejection control.

The disturbance rejection control adopted in this study is a limited state feed back controller in which the optimum target force is calculated as the sum of vehicle's states multiplied by certain feed back gain. Since only three vehicle states namely body vertical velocity, wheel vertical velocity and relative velocity

between body and wheel are chosen in this study, this control scheme is known as limited state feed back controller. The optimum value of the real time target force for the hydraulic actuator is given by

$$\Sigma F_a = [K_1 \quad K_2 \quad K_3] \begin{bmatrix} \dot{Z}_s \\ \dot{Z}_u \\ \dot{Z}_u - \dot{Z}_s \end{bmatrix} \quad (5)$$

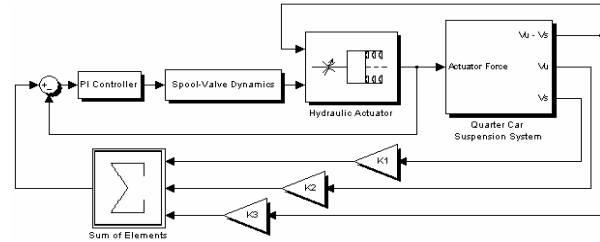

Figure 9: The controller structure of an active suspension system

4.3 Simulation Results

In this simulation study, the typical road disturbance is shown in Figure 10 and set in the form of

$$Z_r = \begin{cases} \frac{a(1 - \cos(8\pi t))}{2} & \text{if } 0.50 \leq t \leq 0.75 \text{ and } 3.00 \leq t \leq 3.25 \\ 0 & \text{otherwise} \end{cases} \quad (6)$$

where, a denotes bump amplitude which is set to be ± 8 cm. This type of road disturbance has been used by D'Amato and Viassalo [15] and Sam *et al.* [16].

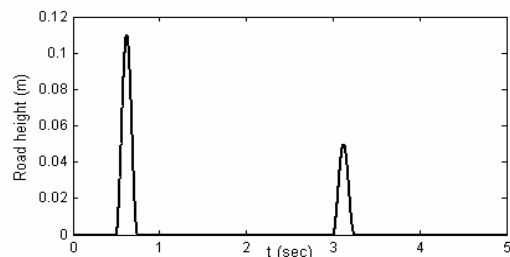

Figure 10: Bump configuration

The numerical values of quarter car model parameters are as the followings:

- $M_s = 282$ kg
 $M_u = 45$ kg
 $K_s = 17900$ N/m
 $C_s = 1500$ Nsec/m
 $K_t = 165790$ N/m

The simulation was performed for a period of 5 second using Heun solver with a step size of 0.001 second. The state feed back gain is set to $K = [4500 \ 200 \ 500]$. The body acceleration and body displacement performances of active system compared with passive system are shown in Figures 11 and 12. From the figures, it is clear that the active system is able to significantly reduce both amplitude and the settling time of unwanted body motions in the forms of body acceleration and body displacement as compared with the passive system.

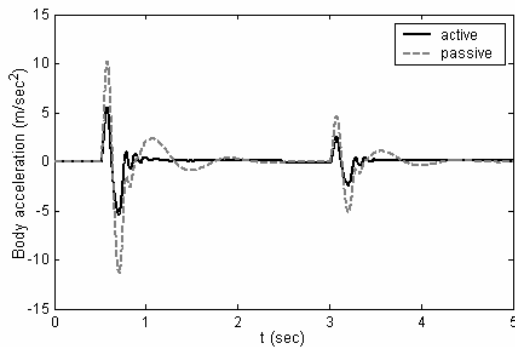

Figure 11: Body acceleration

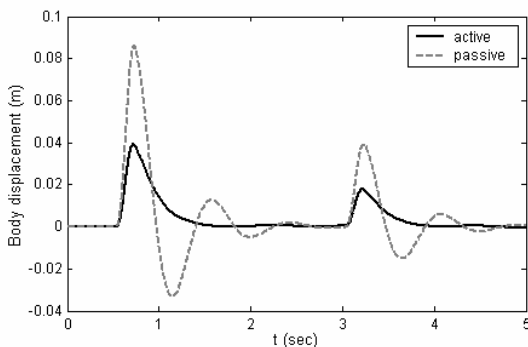

Figure 12: Body displacement

The similar trend was found on the suspension deflection performance as shown in Figure 13, in which the active system shows significant performance in reducing both amplitude and the settling time compared with the passive system. It is also noted that the active system is able to improve the rattle-space dynamics of the suspension system.

In term of the wheel displacement, it can be seen that the magnitude of the wheel displacement for the active system is slightly worse than the passive system as shown in Figure 14. Roughly, the magnitude of wheel displacement of the active system is about 1% larger than the passive system. But, it can be seen that the settling time of wheel-hop for the active system is better than passive system.

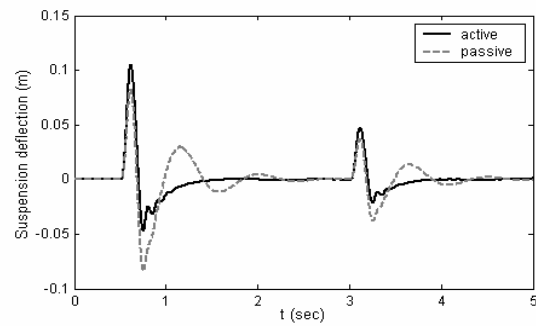

Figure 13: Suspension deflection

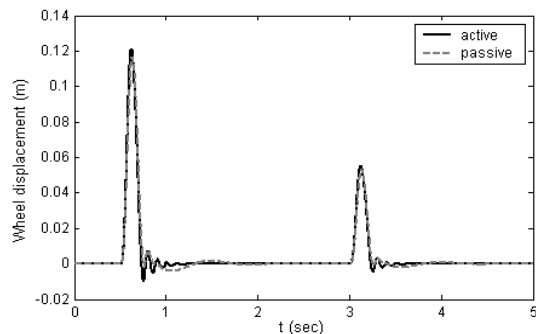

Figure 14: Wheel displacement

The force tracking performance of the inner loop controller is shown in Figure 15. It is clear that the hydraulic actuator is able to provide the actual force close to the optimum target force for the specified bump configuration. From the figure, it can be seen that when the tyre hit the bump with positive magnitude as shown in Figure 10, the hydraulic actuator produces negative force to prevent the vehicle body in moving upward and to lift up the wheel in following the bump profile.

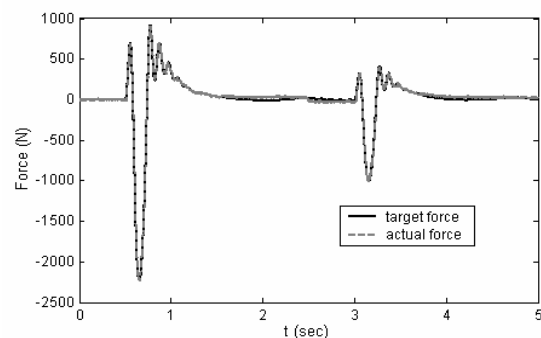

Figure 15: Force tracking performance

5 Conclusions

The paper presents modelling and force tracking control of hydraulic actuator to be used for an active suspension system. Proportional Integral control was implemented for force tracking control of the hydraulic actuator. The results of the study show that the hydraulic actuator is able to provide the actual force close to the target force with acceptable force tracking error.

A limited state feed back controller was used to reject the effects of road disturbance to the vehicle dynamics performance. From the simulation results, it can be seen that the limited state feed back controller shows significant improvement in reducing both magnitude and settling time of the body acceleration, body displacement and suspension displacement. In term of the wheel displacement, it is noted that even though the magnitude of the wheel displacement for the active system is slightly worse than passive system, the settling time of wheel-hop for the active system is better than passive system.

Acknowledgement

This research is supported by the Ministry of Science, Technology and Innovation (MOSTI) Malaysia through the IRPA Grant of 'Robust Control for Active Suspension System' research project lead by Assoc. Prof. Dr. Yahaya Md. Sam. The authors are grateful to the Ministry for supporting the present work.

References

- [1] D. Hrovat, "Survey of Advanced Suspension Developments and Related Optimal Control Applications," *Automatica*, vol. 33, no. 10, pp. 1781-1817, 1997.
- [2] X. Shen, and H. Peng, "Analysis of Active Suspension Systems with Hydraulic Actuators," in *Proceedings of the 2003 IAVSD Conference*, Atsugi, Japan, August - 2003.
- [3] Y. Zhang, and A. Alleyne, "A Practical and Effective Approach to Active Suspension Control," in *Proceedings of the 6th International Symposium on Advanced Vehicle Control*, Hiroshima, Japan September - 2002.
- [4] S. Chantranuwathana, Adaptive Robust Force Control for Vehicle Active Suspensions. University of Michigan: Ph.D. Dissertation, 2001.
- [5] S. Chantranuwathana, and H. Peng, "Practical Adaptive Robust controller for Active Suspensions," in *Proceedings of the 2000 ASME International Congress and Exposition*. Orlando, Florida, 2000.
- [6] M. Ahmadian, "A Hybrid Semiactive Control for Secondary Suspension Applications," in *Proceedings of the Sixth ASME Symposium on Advanced Automotive Technologies*. November. Dallas, Texas, November - 1997.
- [7] M. Ahmadian, and N. Vahdati, "An analytical Evaluation of the Transient Dynamics of Semi Active Dampers," in *Proceedings of the International Mechanical Engineers Conference..* Washington, DC, Paper No. 43254, November 16–21, 2003.
- [8] S. Ikenaga, Development of a Real Time Digital Controller: Application to Active Suspension Control. University of Michigan: Ph.D. Dissertation, 2001.
- [9] M.D. Donahue, Implementation of an Active Suspension and Preview Controller for Improved Ride Comfort. University of California at Berkeley: MSc. Theses, 2001.
- [10] N. D. Sims, R. Stanway, D. J. Peel, W. A. Bullough, and A. R. Johnson, "Controllable Viscous Damping: An Experimental Study of an Electrorheological Long-Stroke Damper Under Proportional Feedback Control," *Journal of Smart Materials and Structure*, vol. 8, pp. 601–615.
- [11] C. W. Lai, and W. H. Liao, "Vibration Control of a Suspension System Via a Magnetorheological Fluid Damper," *Journal of Sound and Vibration*, vol. 8, pp. 527-547, 2002a.
- [12] C. W. Lai, and W. H. Liao, "Harmonic Analysis of a Magnetorheological Damper for Vibration Control," *Journal of Smart Materials and Structure*, vol. 11, pp. 288-296, 2002b.
- [13] F. J. D' Amato, and D. E. Viassalo, "Fuzzy Control for Active Suspensions," *Journal of Mechatronic*, vol. 10, pp. 897-920, 2000.
- [14] Y. M. Sam, J. H. S. Osman, and M. R. A. Ghani, "A Class of Proportional-Integral Sliding Mode Control with Application to Active Suspension. System," *System & Control Letters*, vol. 51, pp. 217-223, 2004.