

# Interference and Electromagnetic Compatibility Challenges in 5G Wireless Network Deployments

Idrissa Abubakar<sup>1</sup>, Jafri Din<sup>\*2</sup>, Manhal Alhilali<sup>3</sup>, Hong Yin Lam<sup>4</sup>

<sup>1,2,3</sup>Wireless Communications Center, Faculty of Electrical Engineering, Universiti Teknologi Malaysia, Skudai 81310 Johor, Malaysia

<sup>4</sup>Department of Electrical Engineering Technology, Faculty of Engineering Technology, Universiti Tun Hussein Onn Malaysia, Parit Raja, Batu Pahat 86400 Johor, Malaysia

<sup>1</sup>Satellite Network Operations Center (NOC), Nigerian Communication Satellite Ltd, Abuja, Nigeria

\*Corresponding author, e-mail: jafri@utm.my

## Abstract

5G wireless network technology is going operate within the environment of other electrical, electronic and electromagnetic devices, components and systems, with capability of high speed data connectivity acting as network transceiver stations with Massive MIMO for Internet of Things (IoT). Considering the level of interoperability, electromagnetic Interference and electromagnetic compatibility to avoid electromagnetic pulse effects (EMP) which is capable of not only causing network malfunctions but total devices and equipments failure in mission critical operations, like hospital MRI scan machines, security profiling and data handling or even personal healthcare devices like heart pacemaker. Electromagnetic energy coupling in PCB due to: radiation, reflection and Crosstalk generates reliability challenges affecting Signal Integrity between traces of multilayer boards stalks, power bus and packaging creating Electromagnetic interference (EMI) in PCB leading false clock response to system failure. Above were considered very essential when deploying 5G wireless network facility as presented in this paper.

**Keywords:** Internet of Things (IoT), EMC, MIMO, Crosstalk, Signal-Integrity

**Copyright © 2017 Institute of Advanced Engineering and Science. All rights reserved.**

## 1. Introduction

Electromagnetic fields, waves propagation and signal transmission are part the the fundamentals of wireless network and access to telecommunication service while we consider the deployments of 5G service to enhance connectivity to broadband services (voice, video and data) which 4G technologies still have some challenges to achieve the required throughput as the demand for connectivity to network access is increasing daily from all works of life. This will require the use of higher frequency as well as backhaul capabilities, owing to some environmental dynamics such as power, interference and reliability as well as electromagnetic effects which includes includes but not limited to: electromagnetic compatibility (EMC), electromagnetic interference (EMI), and electromagnetic pulse (EMP) which can result in network malfunction. Considering Common-mode radiation which is an electromagnetic (EM) radiation caused by current flowing in an undermanaged trace (or trace terminated with a high input impedance device) and may require load terminating resistors to eliminate reflections, it can only be realised when proper design procedure and regulations are enforced from the regulatory authorities. However, when not properly designed or implemented behaves like a mono-pole antenna with the magnitude proportional to the current per length and operating frequency. Accordingly, the amplitude of the harmonic components decreases as the frequency is increased, leading to significant distortion in trace, vias and bus behaviours when used as in massive MIMO antennas or traces. Jamming signals generated by other competing devices in the network expands to spectrum between 10MHz to 300 MHz [1-2].

Fundamentally, electromagnetics system views that signal interference and its pathways are either radiated or conducted. Radiated interference is actually the main source of interference transmitted over the wireless networks as the medium in relation to electromagnetic propagation, and is generally considered to embroil the transfer of energy through the inductive and capacitive coupling of energy in the form of cross talk, noise, and reflections thereby distorting the VSWR of the parallel traces in electronic devices. On the other hand, conducted

interference originates from the nearby sources through the coupling capacitors, inductors and common impedance mismatch above the threshold for jamming equipment in the network of connectivity. In this paper, EM radiation effects on electronic equipment have been discussed as it relates to 5G wireless network deployments within the same environment operating at higher frequency with other devices for Internet of Things (IoT).

Unnecessary discharge of electromagnetic waves is connected with transmitting, switching and the susceptibility of circuits in high-speed digital system generate more questions to Printed Circuit boards (PCB) designers which will require a review of skills and norms. This is because at high frequency signal traces in PCB behave like a loop antenna because of its differential-mode in radiation resulting from line currents consisting of harmonic frequency components flowing through the loop as can be seen from Figure 1. EM radiation is composed of electric (E) and magnetic (H) fields. The alternating flux density of magnetic field produces an electric field changing in time and space (Faraday's Law). A time-varying magnetic field produces an electric field while time-varying electric field results in a magnetic field [3-4]. This forms the basis of electromagnetic waves/time-varying electromagnetic (Maxwell's Equations).

$$V = L \frac{di}{dt} . \quad (1)$$



Figure 1. Radiation effect of mono-pole antenna in transmission line of PCB

In Massive MIMO the capability of decreasing the multiple radiated power and the increased data rates, are of important concern while considering the total power consumption of baseband signal processing systems and devices. More studies to investigate these defects are required in highly specialized hardwares for the baseband signal processing during PCB design process. Radio Frequency equipments such as, up converters, High power amplifiers, band pass filters, input multiplexers, RF receivers, frequency down converters, local oscillators, analog-to-digital converters, baseband devices, modulators and demodulator, solid state power amplifiers as well as duplex converters, will require a critical EMC/EMI analysis for RF components and functions in 5G mobile devices [5].

## 2. Review of Literature

Electromagnetic Interference (EMI) is in most cases generated by unwanted emission or retransmitted line voltages and currents from a source emitter and is then sensed by a susceptible victim along its transmission coupling path which can be associated with one or all of the following: - Conduction - electric current; Radiation - electromagnetic field; Capacitive coupling - electric field and Inductive coupling - magnetic field.

Conducted noise is coupled between components through interconnecting wires such as the power supply bus and ground wires. Radiated electromagnetic field coupling includes but not limited to the near field regions as both (E) field and (H) field coupling are considered separately. While in the far field region, the coupling pathway is considered as a plane wave coupling mechanism. Similarly, the capacitive or Electric field coupling is generated because of a voltage difference between conductors of the same net modeled by a capacitor as it acts like an energy storage. While the Inductive/Magnetic field coupling is largely from the current flowing in conductors which is modeled by a transformer function in the circuit. Some additional radio interference to other equipments when fully operational in the 5G capabilities and IoTs will as well includes electric field transmitted as noise or thermal effects from: TV sets, broadcast

receivers, telephone lines appliances and communications receivers [4] as can be seen in Figure 2.

Since Massive MIMO provides the capability of reducing the multiple radiated power as well as increased data rates, while considering the total power consumption of baseband signal processing. Considerations for Radio Frequency equipments such as, up and down-converters, analog - digital system translators and vice versa, will require a critical EMC/EMI analysis for transceiver functions as mobile devices.



Figure 2. Internet of Things (IoT) in 5G network architecture

Radio Transmitters, includes mobile communication system, radio, television, radar and pulse scanner, navigation trackers and radio relay communication system; such as microwave radio relay for satellite backhaul. In these the emitted power is larger, the fundamental signal can produce functional interference; harmonic and spurious emission is non-functional form of unwanted signal interference. Industrial, Scientific and Medical Equipment: Induction heating equipment, high frequency welding machine, X-ray machine, high frequency therapy equipment is considered [5].

With 5G transmission networks being debated due to frequency congestion and bandwidth requirements for broadband services with other devices in the same environment and hot spot wireless connectivities, the configuration of chipset now leads to quality of service challenges [6-7]. However, as speed increases, high-frequency effects become critical, and even the shortest lines can experience the concerns such as ringing, crosstalk, reflections and ground bounce, seriously hampering the response of the signal thus damaging signal integrity [8].

"Massive MIMO" configuration has in the recent shown to improve bandwidth utilisation with reliability in service performance for distance-dependent pathloss and channel coherence time and bandwidth, this distance dependency must take into account the radiation limit in order to achieve the designed system performance threshold as well as avoid interference that may result in product failure [9].

Recent works in massive multiple-input multiple-output (MIMO) show that the user channels decorrelate when the number of antennas at the base stations (BSs) is increased, which allows for signal gains along the propagation line however the inter-user interference should be given a priority attention as the reason for gain increase will somehow be defitted as well [10].

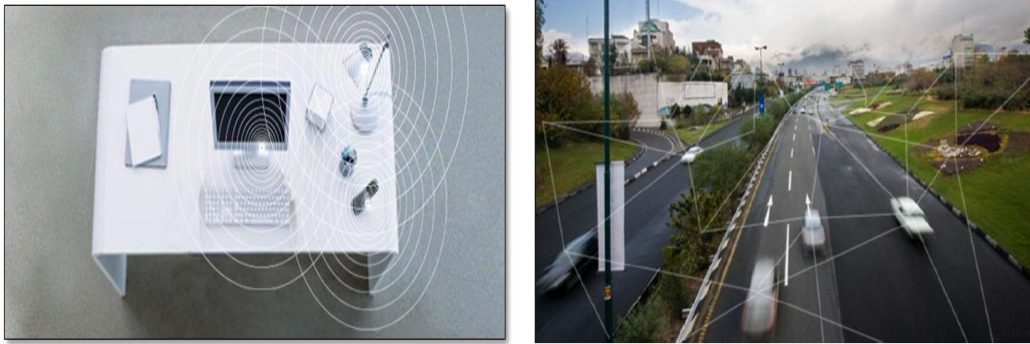

Figure 3. EM wave interaction that results in interference effects

Similarly, the perception and response of network users or subscribers as can be seen from Figure 3, can also be influenced by EM wave interaction while propagating from network of (IoT) in an environment where 5G network deployed creating unstable behavior such as one irrational crowd [11].

### 2.1. Signal Integrity in PCB

Signal integrity (SI) in practice is concerned with quality of performance of a signal transmitted from a driver as source and a receiver for efficient operations of the circuit under consideration as in the case of signals over the high-speed bus between data processor and its chipset. The integrity of a signal in real-world applications is affected by architecture of the layout of PCB, the type of IC package used, the logic class, power delivery network, and other factors of high-speed digital design [9]. These non-ideal effects can cause distortion in voltage, current waveforms and signal jitter, generating false switching and logic errors. All these observations are to ensure optimal SI design for high-speed digital circuits as well as effective Crosstalk and Noise optimization.

Crosstalk principally take place in digital system's microchips, the PCB board, connectors, and cables experiencing the strongest crosstalk between the signal lines of microchip packages and connectors causing false switching and timing push-out. Crosstalk is also sub-divided into far-end crosstalk (FEXT) and near-end crosstalk (NEXT). In FEXT, the aggressor signal travels in the same direction as the victim signal. NEXT; on the other hand, is the coupling of the aggressor signal to the victim in the opposite direction, and is in general, much more critical since the strong aggressor signal can couple into and attenuate the victim signal in the connector or package located on the receiver side where the signal is already attenuated.

Figure 4 below depict the FEXT and NEXT crosstalk in a modern package trace and cable. Mutual Inductance and mutual capacitance are the two main factors for causing crosstalk in high speed PCB. The parameters of the PCB board, space between the signal wires, the electronics characteristics of drivers all affects the crosstalk [10].

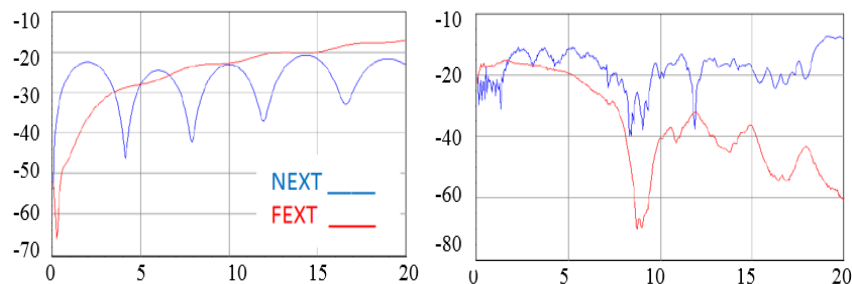

Figure 4. The effects of Crosstalk at - NEXT and FEXT

The magnitude of the NEXT will depend on the mutual capacitance and the mutual inductance.

$$\text{NEXT} = \frac{V_b}{V_a} = k_b = \frac{1}{4} \left( \frac{C_{mL}}{C_L} + \frac{L_{mL}}{L_L} \right). \quad (2)$$

$V_b$  = Voltage noise on the quiet line in the backward direction.

$V_a$  = Signal voltage on the active line.

$K_b$  = Backward coefficient.

$C_{mL}$  = Mutual capacitance per length, in pF/inch.

$C_L$  = Capacitance per length of the signal trace, in pF/inch.

$L_{mL}$  = Mutual inductance per length, in nH/inch.

$L_L$  = Inductance per unit length of the signal trace, in nH/inch

The far end noise voltage is related to the net coupled current through the terminating resistor on the far end. The FEXT coefficient is a direct measure of the peak voltage of the far-end noise, ( $V_f$ ) usually expressed relative to the active signal voltage, ( $V_a$ ).

$$\text{FEXT} = \frac{V_f}{V_a} = \frac{L_{en}}{RT} \times k_f = \frac{L_{en}}{RT} \times \frac{1}{2v} \times \left( \frac{C_{mL}}{C_L} - \frac{L_{mL}}{L_L} \right). \quad (3)$$

$$k_f = \frac{1}{2v} \times \left( \frac{C_{mL}}{C_L} - \frac{L_{mL}}{L_L} \right). \quad (4)$$

$V_f$  = Voltage at the far end of the quiet line.

$V_a$  = Voltage on the signal line.

$L_{en}$  = Length of the coupled region between the two lines,

$K_f$  = Far-end coupling co-efficient that depends only on intrinsic terms,

$v$  = Speed of the signal on the line,

$C_{mL}$  = Mutual capacitance per length, in pF/inch.

$C_L$  = Capacitance per length of the signal trace, in pF/inch.

$L_{mL}$  = Mutual inductance per length, in nH/inch,

$L_L$  = Inductance per length of the signal trace, in nH/inch.

### 3. Problems and Results

In this section of the paper a sequence of methodology for the simulation of is applied using a JTAG Model to simulate for a situation of crosstalk which is an embedded debugging technology that provides for system encapsulated chip having a special test capability commonly known as Test Access Point (TAP) through a dedicated JTAG test tool to test for internal circuit nodes as it provides for multiple input terminal. A series of simulation work has been carried out and is presented in analysis of crosstalk effects in PCB transmission line signal trace because of its standard circuitry testing protocol.

The JTAG test interface allows the use of multiple devices to be connected to its serial chain in order to create a multiple lines and layer to form a JTAG chain in which each device can be realized by respective test creating the possibilities of multi-transmission line traces to generate crosstalk and other signal integrity challenges in the network which is mainly the focus of these work as the 5G wireless network is going to operate in massive MIMO environment. Since the JTAG interface is also commonly used in realization of In-system programming (ISP) function such as FLASH device programming. Using the JTAG input/output interface, the chip

can access all the circuits for developing and debugging embedded system making it a resourceful point for crosstalk analysis [12].

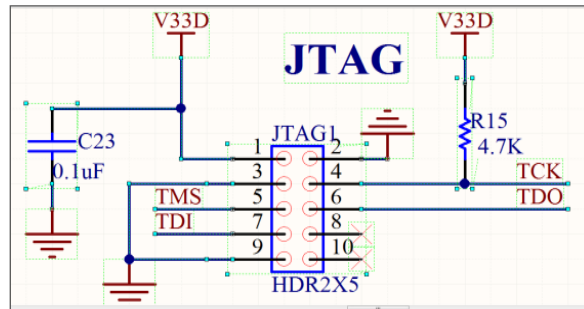

Figure 5. The JTAG schematics

### 3.1. Radiation Simulation of PCB

Daily geometric demands for high speed mobile network for triple play, market forces, economic demand and supply curve, research and knowledge quest, social media and bandwidth in MIMO systems is causing an exponential upsurge in clocking time and PCB bus speed which also increases the potential of the circuit to radiate more unintended signals and to behave more like Taylor's transmission line, compromising its compatibility potential quality. In micro-strip patch antennas and other passive components in PCB, radiation is induced by alternating electric field at edges of board and the power planes induce radiation like micro-strip antennas in the Figure 6.

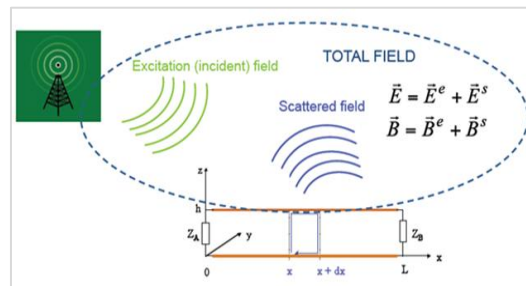

Figure 6. Taylor diagram of interference signals

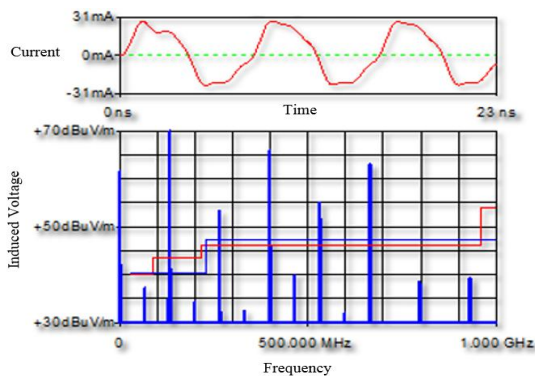

Figure 7. Interference exceeding limit at 3-meter

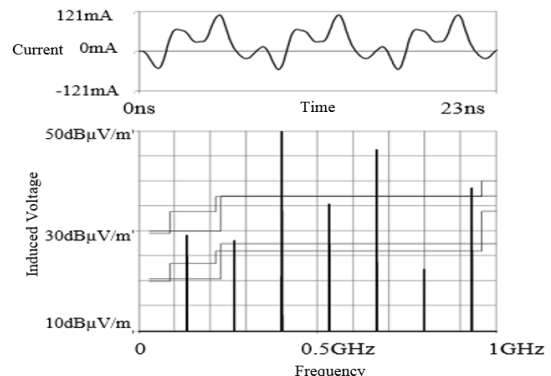

Figure 8. Radiation at 30-meter distance

For the simulation all the components were assigned from the easy.mod list of the simulation software. The simulation was carried out at 133 MHz frequency and 49% duty cycle. The spectrum analyzer was set at 3-meter distance. The simulation was repeated again for 30-meter distance. In Figure 7 and 8 we can see the simulation result at 3 meter and 30-meter distance.

**3.2. Reflection in PCB**

Signal Reflection can produce false clock trigger as the circuit VSWR and impedance match will be altered similar to that obtained in radiation but with variation in magnitude, signal jitter, and increased total emission from PCB. Ringing within transmission line contains both overshoot and undershoot before stabilizing to a quiescent level. Overshoot is the effect of an excessive voltage level above the power rail or below the ground reference. Undershoot is a condition that occurs when the voltage level does not reach the threshold amplitude value for both maximum and minimum transition levels. Overshoot can be optimized using terminations and IC package design. Overshoot, when out of phase can over stress devices into operational failure [13-14]. A simulation was carried in Hyperlynx8.0 at 133 MHz frequency and 49% duty cycle. From Simulation result of the reflection from the selected net as can be seen from Figure 9, shows that at pin P5.16 the ringing noise (red) is more when compared. Delay is more at pin U4.5 (blue).

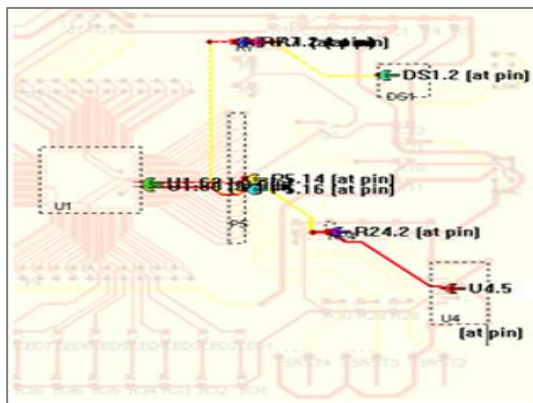

Figure 9. The Near-field net effect in PCB

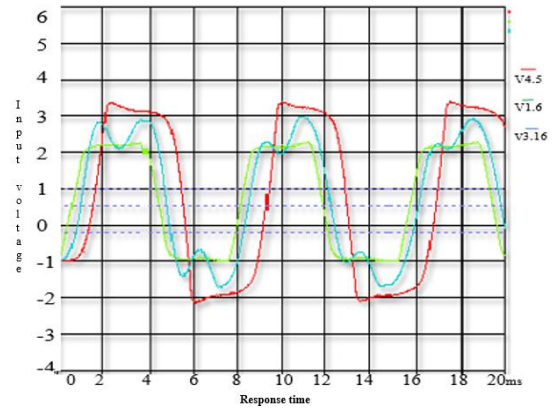

Figure 10. Reflection at 133MHz and 49% duty cycle from Figure 9

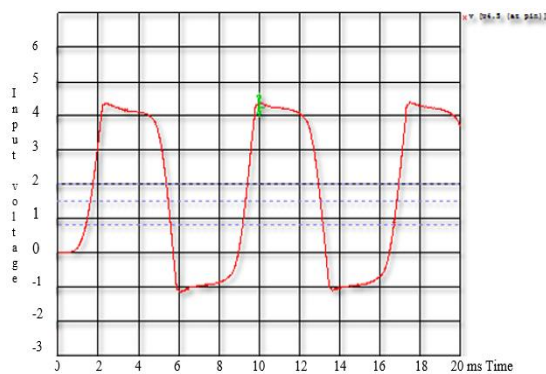

Figure 11. Positive overshoot at pin U4.5 by 138.6 mV

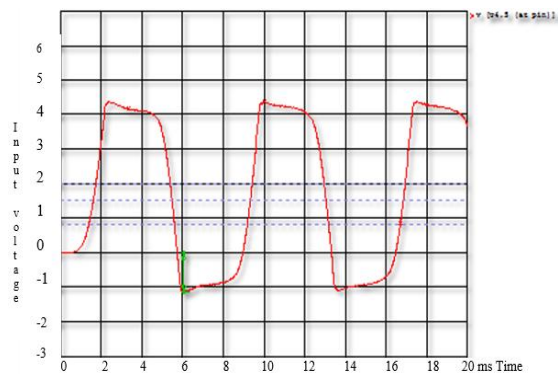

Figure 12. Negative overshoot at pin U4.5 and it is 1.15V

From the above simulation (Figure 10-12) of result it was observed that the network pin U1.60 is the stimulus at the frequency of 133 MHz and duty cycle 49% of the square wave

signal. comparing the waveforms observed at 133 MHz 49% duty cycle, the ringing effect is most at pin P5.16 and maximum positive overshoot also occur at P5.16 which is 870.6mV whereas the maximum negative overshoot (undershoot) occur at pin U4.5 which is 1.15V. The overshoot at U4.5 is 138.6mV. The maximum undershoots at P5.16 is 711.8mV. The maximum overshoot and undershoot at pin U1.60 was 123.5mV and 90.56mV respectively.

**3.3. Crosstalk Simulation**

Crosstalk is the event where energy is coupled from one net to another operating in the same network proximity of EM fields interact with each other as expected in the 5G wireless network or even LTEs may as well generate a third order differential in form of harmonics, and cancelling the all the signal components which can result in system malfunctions or even total failure, hence it is necessary to minimize within acceptable limit of crosstalk before finalizing the design of any product for such applications [15-16]. The simulation result of the cross talk is shown in the following Figure 13, having U1.60 as stimulus.

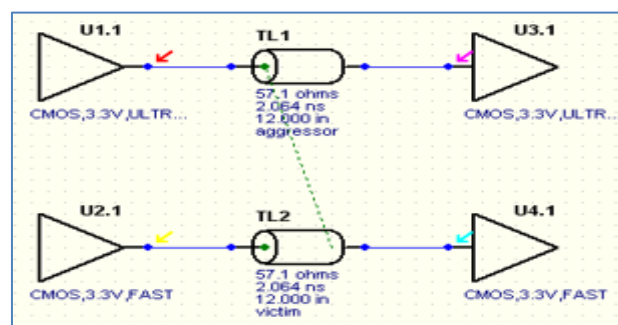

Figure 13. Crosstalk in the parallel net coupling

When two traces are near each other, their electromagnetic fields can interact and introduce noise in the signals flowing through parallel lines, this generate a serious concern in high-speed circuits, since the rapidly changing currents in circuit traces produce high levels of electromagnetic fields, which can introduce significant cross talk in these circuits which can then send a fault command in the case of telemetry signal and telecommand, when such error pulse is interpreted as true command a wrong codes will as well be generated compromising the reliability of the information source from the driver circuit to the receiver.

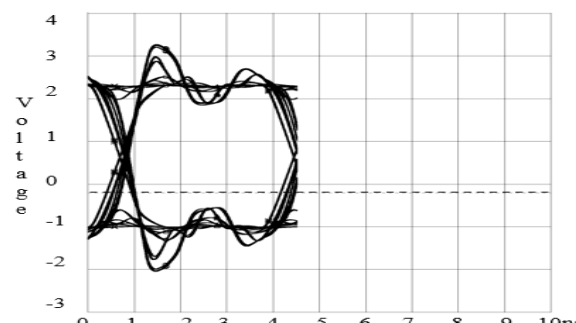

Figure 14. EYE diagram of crosstalk effect on net

From the eye diagram of Figure 14, it shows that inconsistencies in error codes can drive the circuit into resonance giving rise to total system failure as it is operating out of phase with the source command instead of +2V to -2V the response at 1.5ns becomes +3 to -2.



Similar abnormality was observed at 3.5ns resonating from -1.5V to 2.5V as can be seen in Figure 15 and 16.

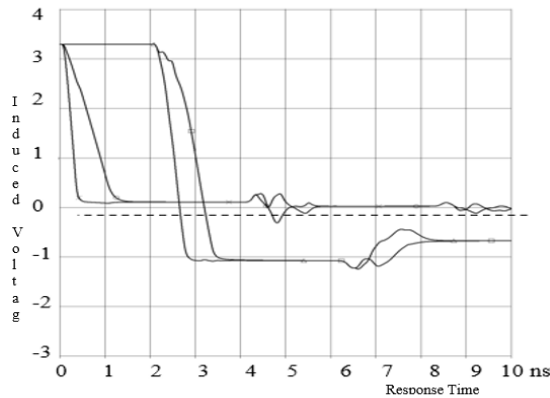

Figure 15. Crosstalk on linear net

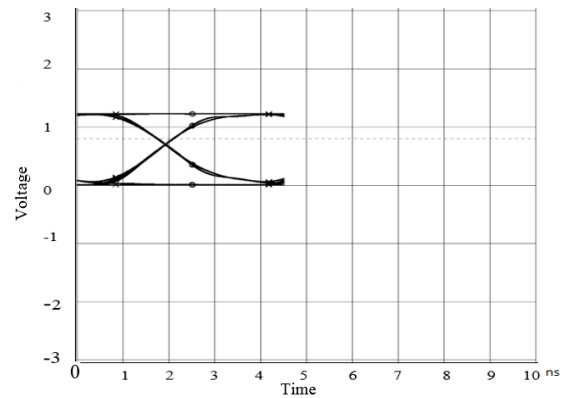

Figure 16. Optimized Eye Diagram with Terminating shunt resistance

**3.4. Results**

Table 1 shows the various simulation results by varying the trace separation between aggressor and victim traces simultaneously. Figure 14, 15 & 16 above shows that by reducing the trace impedance crosstalk also reduced.

Table 1. Crosstalk reduction with spacing

Driver	Receiver	MS1 Trace width (mil)	MS1 Spacing (mil)	Crosstalk (mV)
RF 6.2	J6 2.1	5	5	316.84
RF 6.2	J6 2.1	5	300	0.91
RF 6.2	J6 2.1	5	600	0.23
RF 6.2	J6 2.1	5	900	0.10
RF 6.2	J6 2.1	5	1500	0.04
RF 6.2	J6 2.1	5	2000	0.02
RF 6.2	J6 2.1	5	2500	0.01

Observing from Table 2 below, shows that at 2500mil spacing with both victim and aggressor at constant impedance of 60ohm, the crosstalk was minimized significantly to 0.01mV. Another alternative method of reducing crosstalk in victim line is by connecting the shunt resistance of characteristic impedance at the near end. However, with shunt termination in optimized simulation, the same result was achieved at 1600mils in Table 2.

Table 2. Spacing with shunt termination showing reduction in crosstalk coupling voltage

Driver	Receiver	MS1 Trace width (mil)	MS1 Spacing (mil)	Crosstalk (mV)
RF 6.2	J6 2.1	5	5	283.21
RF 6.2	J6 2.1	5	300	0.59
RF 6.2	J6 2.1	5	600	0.14
RF 6.2	J6 2.1	5	900	0.06
RF 6.2	J6 2.1	5	1500	0.02
RF 6.2	J6 2.1	5	1600	0.01

**4. Conclusion**

With the developments in technology permitting 5G network to be deployed for wireless services creating a networks of Internet of Things (IoT) a standardized approach becomes a

necessity as well as consideration for open interface process to address the challenges of EMI/EMC issue as multiple radiation sources can exceed the acceptable limit. The advantage of detailed design consideration is there will be no reason to RECALL the product once it hits the market. Signal Interference issues are vital in determining the performance of a high-speed transmission line in PCB design, where Crosstalk effect from unintended EM fields coupling between traces, wires, cable harnesses, vias and electrical power equipments are susceptible to EM fields interference causing the signal at the receiver to experience a high level of distortion. This paper treats the problem of electromagnetic coupling of energy in connection with 5G that will cause interference for un-intended application which may result in signal Jamming. The use of multiple antennas for high gain in effective isotropic radiated power (EIRP) for service deployments using (MIMO) technology for cell site coverage, cell hand-off and power utilization for devices in the world of Internet of Things (IoT) that must coexist on the same PCB with electronic components to avoid false clock and transfer of error commands.

### Acknowledgements

This work has been funded by Ministry of Education Malaysia (MOE) and UTM under "Research University Grant" "FRGS" Vot. No. R.J.130000.7823.4J221. the authors are very grateful for all the support and encouragements.

### References

- [1] Paul CR. Introduction to electromagnetic compatibility. John Wiley & Sons. 2006.
- [2] Paul CR. Analysis of multiconductor transmission lines. John Wiley & Sons. 2008.
- [3] Rahman TA. Malaysia Towards 5G Standardization and R&D Activities. 2015.
- [4] Chuang TH, Chen GH, Tsai MH, Lin CL. Alleviating Interference through Cognitive Radio for LTE-Advanced Network. *International Journal of Electrical and Computer Engineering*. 2015; 5(3): 539.
- [5] Erik G, et al. *Massive MIMO for Next Generation Wireless Systems*. In *IEEE Communications Magazine*. 2014: 189-195.
- [6] Larsson EG, Edfors O, Tufvesson F, Marzetta TL. Massive MIMO for next generation wireless systems. *IEEE Communications Magazine*. 2014; 52(2): 186-195.
- [7] Williams RD. Keeping medical devices safe from electromagnetic interference. *FDA consumer*. 1995; 29(4): 12.
- [8] Hu RQ, Qian Y. An energy efficient and spectrum efficient wireless heterogeneous network framework for 5G systems. *IEEE Communications Magazine*. 2014; 52(5): 94-101.
- [9] Boccardi F, Heath RW, Lozano A, Marzetta TL, Popovski P. Five disruptive technology directions for 5G. *IEEE Communications Magazine*. 2014; 52(2): 74-80.
- [10] Huh H, Caire G, Papadopoulos HC, Ramprasad SA. Achieving "massive MIMO" spectral efficiency with a not-so-large number of antennas. *IEEE Transactions on Wireless Communications*. 2012; 11(9): 3226-3239.
- [11] Mahalleh VBS, Selamat H, Sandhu F. *The effects of distance in dynamic psychological factors of one-dimensional queue*. Control Conference (ASCC), 2015 10th Asian. 2015.
- [12] Bogatin E. Signal integrity: simplified. Prentice Hall Professional. 2004.
- [13] Sharawi MS. Practical issues in high speed PCB design. *IEEE Potentials*. 2004; 23(2): 24-27.
- [14] Rana MM, Islam MR, Hosain MK. Parametric Investigation of Near End and Far End Crosstalks in Printed Circuit Board Lands. *International Journal of Electrical and Computer Engineering*. 2011; 1(2): 213.
- [15] Xiaosong J, Runjing Z. *Crosstalk Analysis and Simulation in High-Speed PCB Design*. 2007 8th International Conference on Electronic Measurement and Instruments. 2008.
- [16] Rana MM, et al. Parametric Investigation of Near End and Far End Crosstalks in Printed Circuit Board Lands. *International Journal of Electrical and Computer Engineering*. 2011; 1(2): 213.
- [17] Rebecca D Williams. Keeping medical devices safe from electromagnetic interference. U.S. Food and Drug Administration website. Obtained online at [http://www.fda.gov/fdac/rep\\_rints/emi.html](http://www.fda.gov/fdac/rep_rints/emi.html).
- [18] David W Feigl Jr. FDA public health advisory: risk of electromagnetic interference with medical telemetry systems. U.S. Food and Drug Administration website. Obtained online at <http://www.fda.gov>.
- [19] United States Naval Air Warfare Center. Glossary: Jamming. Electronic Warfare and Radar Systems Engineering Handbook. Obtained online
- [20] Federal Communications Commission. Interference. U.S. FCC Consumer and Governmental Affairs Bureau website. Obtained online at <http://www.fcc.gov>.