



FLEXURAL PERFORMANCE OF BUILT-UP COLD-FORMED STEEL BEAM FILLED WITH COMPACTED SOIL

Mohd Syahrul Hisyam Mohd Sani¹, Mohd Mawardi Mohd Kamal¹, Fadhluhartini Muftah² and Cher Siang Tan²

¹Faculty of Civil Engineering, Universiti Teknologi Mara Pahang, Pahang, Malaysia

²Faculty of Civil Engineering, Universiti Teknologi Malaysia, Johor, Malaysia

E-Mail: msyahrul210@pahang.uitm.edu.my

ABSTRACT

Cold-formed steel is the well-liked structural materials in the construction industry and used as an alternative construction material upon the traditional material such as reinforced concrete, hot-rolled steel or timber. The purpose of compacted soil is filled into a cold formed steel section to contribute to the environmentally friendly with reasonable strength and can also reduce production costs without concrete beams. The cold-formed steel material is selected and combined with the compacted soil to construct the beam that could increase the ultimate moment. Compacted soil from the Kaolinite group is prepared and tested to find out its properties. Two cold-formed steel channels are connected face to face to form a built-up box section, tightened with bolts and nuts. Three different bolt spacing arrangements are prepared. The main purpose of the study is to determine the ultimate load of the beam with and without compacted soil, as well as to investigate the relationship of the bolt spacing arrangement to ultimate load resistance. From the result, built-up CFS beam with compacted soil (CFSBCS) showed higher values of the ultimate moment compared to built-up CFS beam without compacted soil (CFSB). Bolt arrangement in the middle spacing influenced the overall ultimate load resistance of the beam. The ultimate load resistance reduced when the length subtraction between bolt arrangement, B and C is less. It is concluded that CFSBCS is able to achieve reasonable ultimate moment and also able to increase initial stiffness.

Keywords: cold-formed steel, built-up section, flexural performance, compacted soil.

INTRODUCTION

Cold-formed steel (CFS) is the structural materials that used broadly in civil engineering application especially in residential house and building. The advantages of the CFS are lightweight, corrosion resistance, anti-termite, less maintenance, ease of erection, ease to fabricate and recyclable material. Some example that be used the CFS in construction is the roof truss system, wall panel, storage rack, frame and highway application. Additionally, the CFS was acknowledged as a sustainable green material and contributes the environmental friendly for low rise residential and commercial buildings (Irwan *et al.*, 2011). The CFS is still a popular material in research activity such as the study of their mechanical behaviour to produce the structural element such as column, beam, retaining wall and etc. A lot of study of the CFS and composite CFS structure, which are combined with a normal concrete or special concrete are investigated. However, no information and data that is being or has been investigated by researchers of CFS with soil or compacted soil. The new innovation in composite CFS structure with compacted soil that could be utilised in the building as a ground beam is discussed in this paper.

Typically, compacted soil is produced to make the soil strong, solid and has a higher strength. The combination of the CFS with compacted soil is proposed as the structural element, especially for beam with having a certain high strength and supported closely by their own advantages. The major advantage of the compacted soil is to increase the shear strength of the soil and resist the production of inner water pressures during the soil movement. Compacted soil is used to rearrange back the

particles of soil to become stiff and reduced the air void that existed in the soil. Reduction of air void will cause the water or liquid to flow one part to another part easily on the soil without any absorption. When the compacted soil is used for any application, it could shrink the settlement when subjected to working loads. In order that, the compacted soil must be checked the factors that influenced such as water content in the soil, types of soil, the total amount of compaction and energy of compaction.

Generally, the beam is classified as a stable element when subjected to load and capable to prevent from the beam failure. The beam is failed normally on bending, shear, torsion or combination other minor factor. In cold-formed steel beam (CFSB), the section will be weaker because of buckling, bending and twisting circumstances have occurred in flange or web or both. Normally, the CFSB with a thin section was fail to local, distortional, twisting and lateral-distortion due to their unsymmetrical section and lastly, the bending strength may decrease. Yu and Schafer (2007) has reported the laterally braced CFSB commonly experience from one or both instabilities circumstances which known as local or distortional buckling. The CFSB with a stable profile is proposed that can minimise the failure due to buckling. The CFSB is formed into built-up CFSB by using a bolt and nut with three different arrangements. The connection of the built-up CFSB is important for the beam to ensure the beam stable when subjected to load. The CFS channel section is classified as a singly-symmetrical section and the stability of the section is doubted when compared to built-up section. Normally, built-up CFS channel section can be formed into two shapes i.e. box section and back-to-back I-section. The connection of the built-up CFS



section uses the self-drilling screw, self-tapping screw, bolt and nut or welding. Study of the types connection for the built-up section is a popular research, such as Tabrizi and Hosseini (2012), Muftah *et al.* (2013) and Landolfo *et al.* (2008). Xu *et al.* (2009) has reported built-up CFS widely used with fastened by using self-drilling screws in low and mid-rise residential, and commercial building in North America.

GREEN TECHNOLOGY PERSPECTIVE IN THE STUDY

The beam that proposed in the study is considered the green technology perspective in construction and civil engineering. Firstly, the usage of the formwork in construction industry can be decreased and the waste material in the construction site also can be reduced. The high percentage of waste material in construction site formed the unsafe condition and the limited space for waste dumping purposes such as in urban and congested area. Restrict the waste material was helped achieve the principle of sustainable development in the construction site. Sometimes, the waste material is dumped in one place and burned for the purpose of disposal. As a result, CO₂ emissions make the highest percentage contribution to air pollution. Yuan *et al.* (2013) has reported the large amount of construction waste that was buried, will be produced of CO₂ and methane from anaerobic degradation of the material. Consequently, the green technology is not recognised and practiced in construction field. Table-1 was noted the amount of waste that produced at construction site around Batu Pahat, Johor, Malaysia. It showed that the timber establish a highest percentage when compared with other waste material in construction site. Researchers have decided that the waste product from formwork preparation and fitting can be eliminated by proposing a precast concrete or other new technology in construction site (Yu *et al.*, 2013).

In addition, the beam is filled with compacted soil will replace the beams are made from normal concrete is known as the traditional method. Hence, it aims to reduce the utilization of cement in a construction site. Typically, the production of cement will create a lot of environmental issues such as air pollution, landslide and noise pollution, and also cause a source of raw material become limited. Chen *et al.* (2010) has reported that the Portland cement industry contributed the high volumes of CO₂ and pollution. Pollution and environmental issues were produced during cement production such as quarry and grind work of the raw material, kiln operations, packing activity, transporting and power generating process (Paoli *et al.*, 2014) (Gallo *et al.*, 2014). Li *et al.* (2014) has recommended the life cycle inventory (LCI) study of cement production industry in China to assess the environmental problem and identify improvements by measuring input and output data. The output data are the important part to evaluate the total of CO₂ emission, primary pollution, hazardous air pollutants, noise pollution and lastly, heavy metal emissions from the cement industry (Li *et al.*, 2014). In addition, the environment temperature inside the building is becoming high when it is made by the concrete and required electrical equipment such as air-conditioning to comfort the space inside the building. The high usage of this equipment may increase the electricity usage and energy consumption, affected human health and usually, not contributed to the green technology principle. Normally, the unstable environment condition is associated with electricity and consumption of energy of air-conditioning systems in the building and also is evaluated equivalently in terms of CO₂ emissions (Izquierdo *et al.*, 2011). The green technology should be practiced in the construction industry to solve the above problems partially or totally.

Table-1. The amount of waste produced in three construction sites around Johor, Malaysia (Nagapan *et al.*, 2013).

Types of Waste	Quantities measurement in cubic meter (m ³) or percentages (%)					
	Construction Site, A		Construction Site, B		Construction Site, C	
	m ³	%	m ³	%	m ³	%
Timber	19.69	46	39.54	50	241.43	80
Metals	1.54	4	0.44	1	13.49	5
Bricks	6.48	15	17.27	22	16.50	5
Concrete	1.44	3	7.44	9	9.14	3
Mortar	2.48	6	1.38	2	10.85	4
Packaging	11.33	26	12.43	16	10.03	3
Total	42.96	100	78.5	100	301.44	100

The studies of CFSB with compacted soil as composite structures are still considered new and still no review and information about it. Therefore, the study was designed to obtain the information about the new

innovations that support green technology perspective and also provide for design purpose. In addition, the study is to evaluate the effect of CFSB with compacted soil in flexural performance and also to investigate the



relationships between built-up connections for CFSB with the ultimate load. In the future, the CFSB with compacted soil can be replaced the ground reinforced beam in a construction site.

EXPERIMENTAL WORK

Preparation of the sample

CFS channel (grades 450), size 100 mm x 50 mm and thickness 2 mm were used. The web slenderness ratio

(h/t) and span-to-depth ratio (L/h) was calculated as 50 and 7, respectively. The CFS was placed on face to face and joined with bolt and nut to form CFSB with length 1000 mm. The grade of the CFS channel is 450 MPa and the elastic modulus is 210 GPa. There are three different arrangements of the bolt in the middle of the beam. The arrangement of bolt and nut was illustrated in Table-2 and Figure-1. The end bolt spacing of the beam is constant, but the middle bolt spacing is varied.

Table-2. The arrangement of bolt and nut on the CFSB.

No.	Description & Symbols	Bolt and nut arrangement		
		A (mm)	B (mm)	C (mm)
1	Cold-formed steel beam without compacted soil (CFSB1)	100	200	400
2	Cold-formed steel beam with compacted soil (CFSBCS1)		200	400
3	Cold-formed steel beam without compacted soil (CFSB2)		250	300
4	Cold-formed steel beam with compacted soil (CFSBCS2)		250	300
5	Cold-formed steel beam without compacted soil (CFSB3)		300	200
6	Cold-formed steel beam with compacted soil (CFSBCS3)		300	200

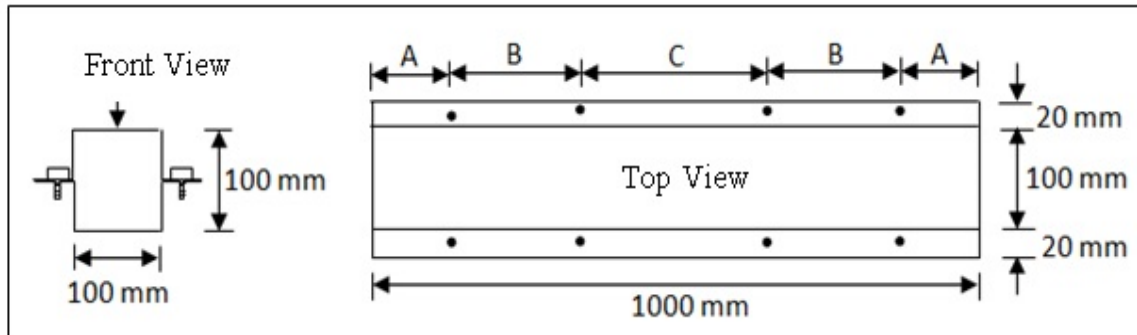

Figure-1. The cold-formed steel channel with the location of the bolts and nuts.

The type of soil that used in the study is clay that classified in the group of Kaolinite. The clay was cleaned from impurities and tested for their properties such as specific gravity, maximum dry unit weights, optimum moisture contents and maximum compressive strength. The unconfined compressive strength test of the compacted soil is using the specimen size, 38 mm of diameter x 88 mm in height. All the result of the compacted soil was recorded before filling into the CFSB. CFSB without compacted soil was filled directly with compacted soil by using the proctor compaction equipment.

Testing procedure

The CFSB without and with compacted soil are tested by using four point bending test as shown in Figure-2. Figure-3 (a) and (b) shows the actual arrangement of the testing of CFSB and CFSBCS, respectively. The load is applied to the beam with

approximately 1/3 and 2/3 on the beam length. The result of ultimate load and extension at ultimate load is recorded. Last part, the bolt that used as a connection in the study was also determined of the ultimate load and extension at ultimate load.

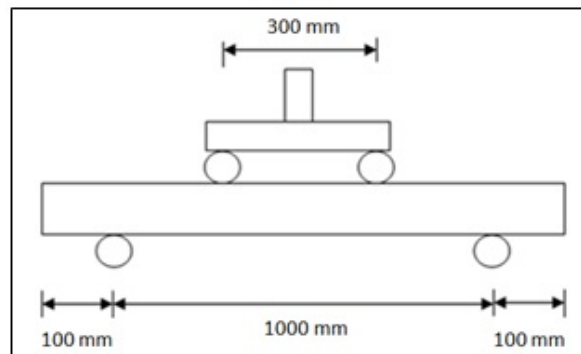

Figure-2. The CFSB arrangement of the flexural testing.



Figure-3. (a) and (b). The testing and the actual arrangement of the CFSB and CFSBCS, respectively.

RESULT AND DISCUSSION

Properties of bolt

The bolt was used to connect the two of the cold-formed steel channel in face to face by using an M6 bolt. The mechanical properties of bolt are shown in Figure-4. The ultimate tensile load is 11.851 kN. Extension at ultimate load is 2.375 mm.

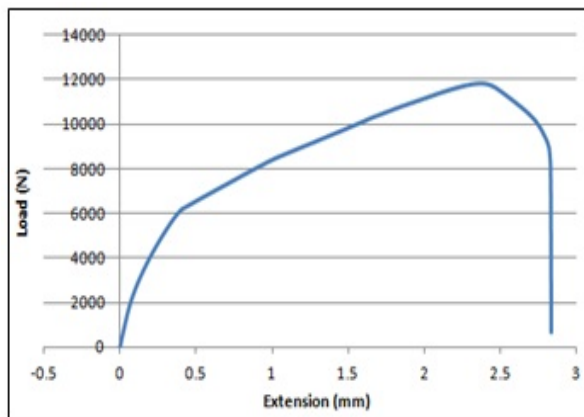

Figure-4. The mechanical properties of the bolt.

Properties of compacted soil

The specific gravity of compacted soil is 2.58. Then, the data is compared with the residual soil, specific gravity 2.25 and noted 12.79 % percentage difference as shown in Table-3. From the standard proctor test, the compacted soil is recorded 1.744 kN/m³ of maximum dry unit weight. The moisture content at maximum dry unit weight is 17.6 %. When compared with the study of kaolinite soil from East Azerbaijan's mines, it showed dry unit weight about 15.1 kN/m³ at 26 % water content at the maximum (Jafari and Esna-ashari, 2012). The standard proctor test was investigated to promote and continue the test of unconfined compressive strength of the compacted soil. From the calculation, 924 ml of volume of water was required in 5.5 kg of compacted soil to achieve the maximum dry unit weight or optimum moisture content as mentioned above.

Then, the compacted soil was extended with the unconfined compressive strength test. The result of the unconfined compressive strength is 78 kN/m² and classified as medium consistency. The unconfined compressive strength of untreated soil is 367 kN/m² was tested by Jafari and Esna-ashari (2012) study and showed 78.75 % as high consistency when compared with compacted soil.

Table-3. The result of specific gravity test.

Properties	Compacted soil	Residual soil
Mass of dry soil used (gm)	190.8	8.5
Mass of water used (gm)	914.7	46.0
Mass of water to fill density bottle (gm)	988.5	49.5
Specific gravity (Mg/m ³)	2.58	2.25
Temperature (°C)	27.0	27.0

Ultimate moment of the cold-formed steel beam without and with compacted soil

The CFSB without compacted soil was tested and showed the highest ultimate moment is CFSB1 as shown in Table-4. CFSB1 is reported having a percentage difference of the ultimate moment by 15.61 % and 4.19 % between the CFSB2 and CFSB3, respectively. Whereas, the CFSBCS1 was recorded as the highest value of the ultimate moment of CFSB with compacted soil is 14.714

kNm. The percentage difference between CFSBCS1 with CFSBCS2 and CFSBCS3 is 21.05 % and 20.65 %, respectively. The percentage difference between CFSB and CFSBCS regarding to the bolt arrangement was stated as 30.53 %, 25.74 % and 16.11 %. The extension at ultimate load has shown the CFSBCS given the high value when compared with CFSB. The percentage difference between the CFSB and CFSBCS between the bolt arrangements is approximately 47.05 %, 11.73 % and 8.49



% . The extension at ultimate load was depended on the ultimate load; high value of ultimate load was ensured the high of extension on the beam. Compacted soils with its strength were given CFSBCS more stiff and stable, and avoid failure in early stage. Figure-5 illustrated the graph of the load versus extension of the CFSB and CFSBCS. Besides, the initial stiffness of the testing are also shown in Table-4. The CFSBCS1 was demonstrated the highest value of initial stiffness, 5.892 and followed by CFSBCS2 with 5.573. The percentage of reduction between the highest and lowest value of CFSB and CFSBCS is recorded as 37.64 % and 14.51 %, respectively.

From observation, the failure mode of the CFSB for three types of beam was identified as local and distortional buckling. Distortional buckling of the CFSB was involved displacement at the bottom junction between flange and web, and twisted to left side as shown in Figure-6. Local buckling of the beam was deformed on the

top junction of the flange which load was applied to it. From the observation, the CFSBCS was only recorded as local buckling failure along the beam section. Normally, local buckling of the CFSBCS was deformed of flange or web individually or both, and the top and the bottom junction between flange and web remaining in an origin position as shown in Figure-6. This is because the CFSBCS was strengthened by the existence of the filling compacted soil in the beam. Figure-7 and Figure-8 were illustrated the failure of the beam section. Figure-7 showed the local buckling occurred at flange and web. Figure-8 showed the compacted soil near the support was loose their compaction and went out of the section. Lastly, the compacted soil in the CFSB was influenced and increased the value of ultimate moment and displacement of the beam.

Table-4. The result of cold-formed steel beam without and with compacted soil.

Specimen	Ultimate Load (kN)	Extension at ultimate load (mm)	Ultimate Moment (kNm)	Initial Stiffness	Percentage Different	Failure mode
CFSB1	29.198	7.679	5.111	4.862	30.53%	L & D
CFSBCS1	42.040	14.502	7.357	5.892		L
CFSB2	24.646	9.880	4.313	3.032	25.74%	L & D
CFSBCS2	33.191	11.193	5.808	5.573		L
CFSB3	27.985	9.320	4.897	3.627	16.11 %	L & D
CFSBCS3	33.361	10.185	5.838	5.037		L

Note: L – Local buckling and D – Distortional buckling

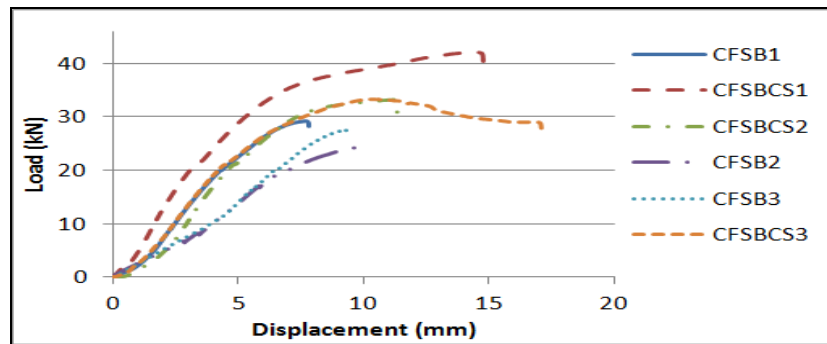

Figure-5. The load versus displacement of the CFSB and CFSBCS.

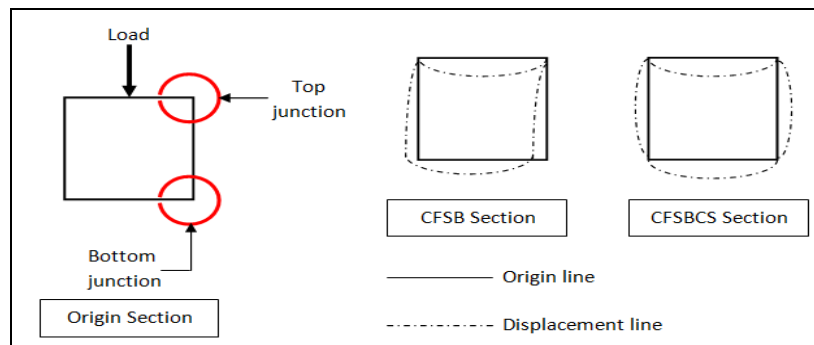

Figure-6. The failure mode arrangement and position of the CFSB and CFSBCS.

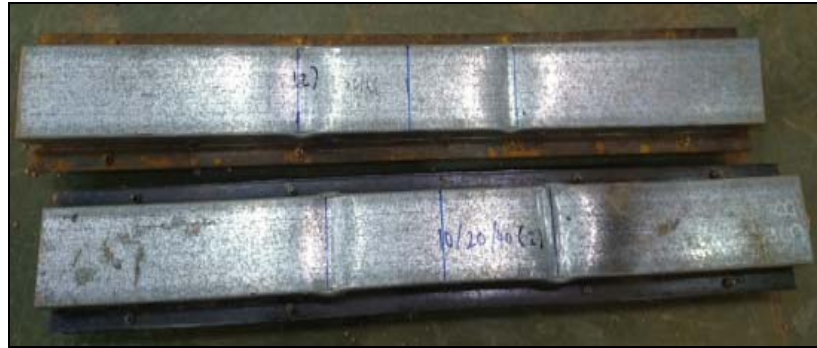

Figure-7. The failure mode of local buckling of the CFSBCS after testing.



Figure-8. The failure of the compacted soil after the test is completed.

Effect of bolt arrangement of the overall flexural performance

The bolt arrangement with three locations of the bolt was noted before as A, B and C. The length of A is same but the length of B and C is varied. The bolt arrangement at B and C is important to calculate the ultimate load and the stiffness of the beam. CFSB1 with 200 mm at B and 400 mm at C was indicated a highest value of ultimate load. The CFSB1 was compared directly with length of B and C. When compared with CFSB2, with the different bolt arrangement, 50 mm at B was identified reduce the ultimate load of 15.59%. In addition, the bolt arrangement at C with different, 100 mm also produced the low ultimate load. The ultimate load of the beam was reduced when the bolt arrangement at B increase 100 mm and C decrease about 200 mm.

Figure-9 (a) and (b) is illustrated the ultimate load versus ratio of A/B and A/C respectively. The ratio of A/B for CFSB and CFSBCS is 0.5, 0.4 and 0.3 and the ratio of A/C for both beams is 0.25, 0.33 and 0.5. The line graph of both beams is still in a same pattern that showed the relevance of the relationship between both variables. The ratio of A/B and A/C with constant length of A is not given directly on the relationship between the ultimate loads. The value of ultimate load at both ratios has shown some irregular circumstances and not considered to be directly proportional relation. Thus, the relationship between the ultimate load and the position of the bolt must be discussed in more detail. The length of B and C is

discussed further to investigate the relationship of the beam.

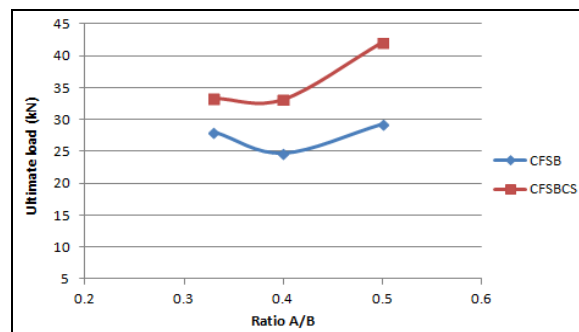

(a)

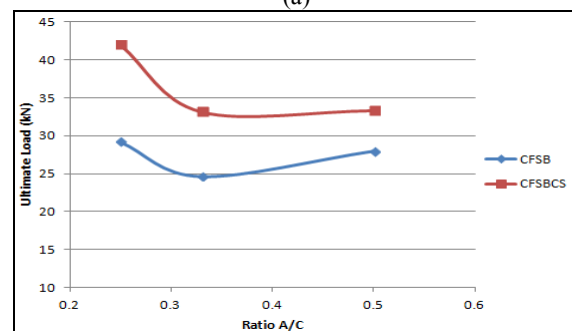

(b)

Figure-9. (a) and (b). The relationship curve between ultimate load with A/B and A/C ratio.



The beams were shown the highest value of ultimate load when the proportion of the length between B and C is appropriate. There are three values of the length subtraction between B and C, 200 mm, 100 mm and 50 mm. This is important to determine the relationship between B and C on the beam. Figure-10 is shown the ultimate load versus length subtraction between B and C. The relationship between the ultimate load and length subtraction of A and B was investigated by producing two questions;

$$0 < d \leq 200 \text{ mm}$$

$$\text{For CFSB, } P_{ult} = 0.0006 d^2 - 0.08 d + 35.801 \quad (1)$$

$$\text{For CFSBCS, } P_{ult} = -0.0004 d^2 + 0.1214 d + 19.485 \quad (2)$$

Where,

P_{ult} – Ultimate load

d – Length subtraction value between point B and C

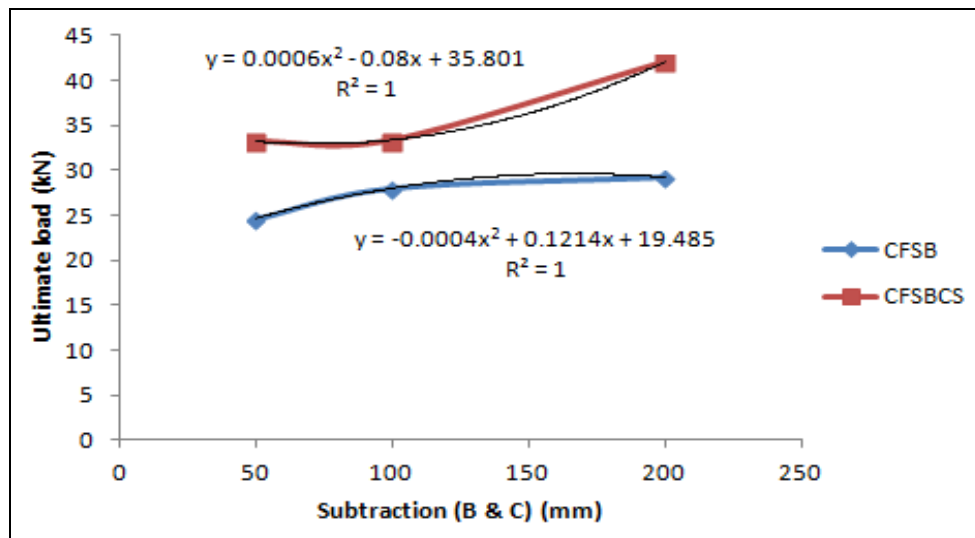

Figure-10. The ultimate load versus length subtraction between point B and C for CFSB and CFSBCS.

CONCLUSIONS

From the flexural testing result, all the CFSBCS is noted a higher value of the moment when compared with CFSB. As a result, the compacted soil in the CFSB is influenced by the strength and stiffness of the beam. The load improvement of the beam was set up and recorded about 30.54 %, 25.74 % and 16.11 % when compared beam without and with compacted soil. The CFSBCS also helped the beam to improve the overall failure mode. The CFSBCS is also reduced the local buckling and deducted the distortional buckling of the beam directly.

The bolt arrangement also influenced the overall ultimate load, moment and extension of the beam. With the same end bolt spacing but different of the middle bolt spacing was effected the ultimate load of the overall beam. The length of B and C is dramatically subjective the value of an ultimate moment of the beam. When the length subtraction between B and C is less, the ultimate moment of the beam has shown a reduction. The equation was produced for CFSB and CFSBCS for calculating the predicted ultimate load with maximum 200 mm, different between length B and C.

The study of the cold-formed steel beam with compacted soil is still a new study and research, and the study is to determine the relationship and information that will be utilised in the design. Less information about the testing, design procedure and regulation, and application

of the material and section are identified to introduce this innovation for further action. In order that, the further investigation, such as a different of the breadth and width of the section, length of the beam, thickness and other relevant structural testing is recommended. Finally, the compacted soil that used in the CFSB is appropriate to promote high strength and reduce the displacement.

ACKNOWLEDGEMENTS

The authors gratefully acknowledge the financial support from the Universiti Teknologi Mara Pahang under Dana Kecemerlangan Grant. Thanks are also extended to Faculty of Civil Engineering, UiTM Pahang for providing machinery and equipment. Special thanks are extended to the lecturer and technician of UiTM Pahang and UTM Johor Bharu for their help during the experimental program.

REFERENCES

- [1] Irwan, J.M., Hanizah, A.H., Azmi, I. & Koh, H.B. (2011). Large-scale test of symmetric cold-formed steel (CFS) – concrete composite beams with BTTST enhancement. Journal of Constructional Steel Research 67, pp 720 – 726.



- [2] Yu, C. & Schafer, B.W. (2007). Simulation of cold-formed steel beams in local and distortional buckling with applications to the direct strength method. *Journal of Constructional Steel Research* 63, pp 581-590.
- [3] Tabrizi, B. E. & Hosseini, M. (2012). Creating relation between bolt arrangements at bolted moment connections among cold-formed steel members using artificial neural network. *International Journal of Advanced Structural Engineering* 4: 6, pp 1-10.
- [4] Muftah, F., Sani, M.S.H.M, Muda, M. F. & Tan, C. S. (2013). Investigation on stress profile of double bolted cold-formed steel channel beam. *IACSIT International Journal of Engineering and Technology* 5, No. 4, pp 466-468.
- [5] Jafari, M. & Esna-ashari, M. (2012). Effect of waste tire cord reinforcement on unconfined compressive strength of lime stabilized clayey soil under freeze-thaw condition. *Cold Regions Science and Technology* 82, pp 21-29.
- [6] Landolfo, R., Mammana, O., Portioli, F., Di Lorenzo, G. & Guerrieri, M. R. (2008). Laser welded built-up cold-formed steel beams: experimental investigation. *Thin-walled Structures* 46, pp 781 – 791.
- [7] Xu, L., Sultana, P. & Zhou, X. (2009). Flexural strength of cold-formed steel built-up box sections. *Thin-walled Structures* 47, pp 807-815.
- [8] Yuan, H., Lu, W. & Hao, J.J. (2013). The evolution of construction waste sorting on-site. *Renewable and Sustainable Energy Reviews* 20, pp 483 – 490.
- [9] Yu, A.T.W., Poon, C.S., Wong, A., Yip, R. & Jaillon, L. (2013). Impact of construction waste disposal charging scheme on work practices at construction sites in Hong Kong. *Waste management* 33, pp 138-146.
- [10] Chen, C., Habert, G., Bouzidi, Y. & Jullien, A. (2010). Environmental impact of cement production; detail of the different processes and cement plant variability evaluation. *Journal of Cleaner Production* 18, pp 478-485.
- [11] Paoli, L., Guttova, A., Grassi, A., Lackovicova, A., Senko, D. & Loppi, S. (2014). Biological effects of airborne pollutants released during cement production assessed with lichens (SW Slovakia). *Ecological Indicators* 40, pp 127-135.
- [12] Gallo, L., Corapi, A., Loppi, S. & Lucadamo, L. (2014). Element concentrations in the lichen *Pseudevernia furfuracea* (L.) Zopf transplanted around a cement factory (S Italy). *Ecological Indicators* 46, pp 566-574.
- [13] Li, C.; Nie, Z.; Cui, S.; Gong, X.; Wang, Z. & Meng, X. (2014). The life cycle inventory study of cement manufacture in China. *Journal of Cleaner Production* 72, pp 204-211.
- [14] Izquierdo, M.; Moreno-Rodriguez, A.; Gonzalez-Gil, A. & Garcia-Hernando, N. (2011). Air-conditioning in the region of Madrid, Spain: an approach to electricity consumptions, economics and CO₂ emissions. *Energy* 36, pp 1630-1639.
- [15] Nagapan, S., Rahman, I.A., Asmi, A. & Adam, N.F. (2013). Study of site's construction waste in Batu Pahat, Johor. *Procedia Engineering* 53, pp 99 – 103.