

HYBRID BEAM-TO-COLUMN CONNECTIONS FOR PRECAST CONCRETE FRAMES

**Ahmad Baharuddin Abd. Rahman, Dennis Chan Paul Leong,
A. Aziz Saim, Mohd. Hanim Osman**
Faculty of Civil Engineering,
Universiti Teknologi Malaysia, 81310 UTM Skudai, Johor, Malaysia.

ABSTRACT: The connections between precast concrete components play an important role in determining the successful of precast concrete framed structures. In particular, the connection between beam-to-column that will affect the load distribution, strength, stability and constructability of the global structure. The understanding on the behaviour of the connection is important and can only be assessed by conducting experimental tests. The main objective of this research is to investigate the moment of resistance and the behaviour of simple beam-to-column connections in precast concrete frames. The experimental test comprised a total of four specimens, which were limited to simple beam-to-column connections in precast concrete frames. The behaviour of load-displacement relationships, moment-rotation relationships and types of failure in connections are also investigated. Moreover, the development of safe, economical, simple and ductile precast beam-to-column connections conforming to building code requirements could be proposed.

Keywords – beam-column frame; simple connections; precast concrete.

1. Introduction

The introduction of Industrialized Building Systems (IBS) in Malaysia has highlighted the importance of precast concrete application in the modern construction industry. Furthermore, due to the high cost of structural steel sections, precast concrete construction has gained popularity with engineers and architects.

The success of precast concrete buildings depends on the connections of the components in particular beam-to-column connections. Typical precast beam-to-column connection details that are recommended by the Prestressed Concrete Institute (PCI) have indicated one or more disadvantages, such as slow erection, no reliable moment capacity, construction tolerance problem and expansive connection hardware [1].

According to Elliot *et al.* (1998), some 24 tests had been conducted using welded plate and billet connectors, however, research on the concrete corbel with stiffened cleat types have not widely carried out. Although the Prestressed Concrete Institute (PCI) manual contains descriptions of typical beam-to-column connections fulfilling many functions, the published test results are available for only a few of them [2]. Therefore there is still lacking of experimental data for the ductile connection details for beam-to-column connection in precast structure. In addition, reliable connection behaviour can only be properly assessed by laboratory testing or proven performance [2].

2. Research Objective

The main objectives of this research are as follows:

- i. To determine the moment of resistance of beam-to-column connections in precast concrete frames
- ii. To study the behaviour of beam-to-column connections.

The research is limited to simple (pinned) beam-to-column connection in precast concrete frames. The precast beams, corbels and columns for this testing were designed based on BS8110:1997. According to clause 5.1.2 BS8110: Part 1: 1997, the recommended methods of design and detailing of reinforced concrete and prestressed concrete can also be applied to precast concrete. The steel connectors such as angles, plates and bolts were designed based on BS 5950:2000. To investigate the response of pinned connections, a total of four specimens are used in this test. Each specimen comprises a 200×300mm cross-section with 1000mm length beam, and is jointed with a supported corbel of 200mm wide and 220mm depth and a precast column of 200×200×2000mm. All specimens have concrete strength of 40N/mm² at 28 days. The experimental testing is conducted to study the behaviour and performance of beam-to-column connections in precast concrete frames.

3. Research Significance

The structural behaviour of the connection such as beam-to-column connections will affect the strength, stability and constructability as well as load distribution of the structure under load. In this research, laboratory testing will be conducted to assess the behaviour and performance of the beam-to-column connections by studying the load-displacement relationships, moment-rotation relationships and failure mode in the pinned connections.

Based on the results obtained, the use of the proposed connections with either precast concrete braced frame (with lateral stability systems such as shear walls) or unbraced frame (without lateral stability systems) can be studied. Furthermore, it is expected that the proposed connections can be utilized in future precast concrete construction as shown in Figures 1 and 2. In addition, the formation of safe, economical and ductile precast beam-to-column connections conforming to building code requirements can be achieved.

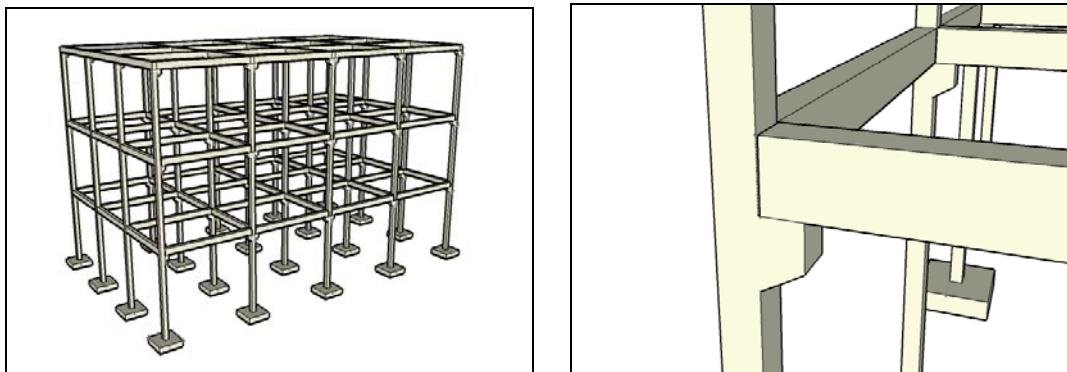

Figure 1 The application of simple beam-to-column connections in precast concrete skeletal frame

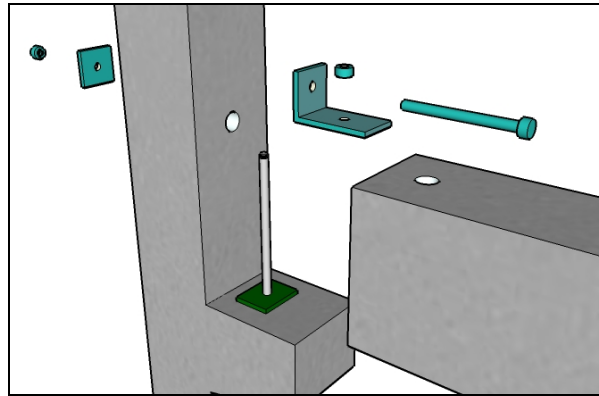

Figure 2 Proposed hybrid beam-to-column connection in precast concrete frame

4. Experimental Research

The experimental test was conducted to study the performance of beam-to-column connections in precast concrete frames (see Figure 3). A total of four specimens of beam-to-column connections were designed and formed to study the connection behaviour under static incremental load.

For specimen 1 (see Figure 4), it was a simple (pinned) connection with 16mm diameter dowel bar projecting from the corbel in the precast column. The precast beam with 40mm diameter dowel sleeve hole, which was cast inside the beam, would be inserted into the projecting dowel and supported by a rubber bearing pad of 150×80×10mm. Then, non-shrink grout was filled into the hole to complete the connection.

While for specimen 2 (see Figure 5), it was similar to specimen 1 but with an additional top angle cleat of 150×90×10mm thick and 80mm wide. The projecting dowel bar was bolted through the seating angle cleat. A 16mm diameter threaded bolt was then inserted to the seating cleat to pass through the column, bolted with 80×80×10mm thick plate at the other end after grouting was completed (see Figure 10).

Specimen 3 (see Figure 6) was connected using the same method, except the angle cleat of 150×90×10mm thick and 80mm wide had been stiffened with two side plates. Finally, specimen 4 (see Figure 7) was a modification of specimen 3, with stiffened angle cleat of 150×90×10mm thick and 150mm wide. The connection involved the bolting of two 16mm diameter threaded bolts that passed through the column.

All columns and beams were reinforced with 20mm diameter high yield steel bars as the main reinforcement. For main reinforcement bars in the corbel, 16mm diameter high yield steel bars were used. Mild steel stirrups of grade 250N/mm² with 8mm diameter were used for shear resistance in the precast beams and columns. For the corbel, 12mm diameter high-yield steel bars were used as shear links. The concrete mix was designed for compressive strength of 40N/mm² at 28 days for all the components.

Figures 8 to 11 show the preparation of the precast component of beams and columns, whereas Figure 12 shows the steel accessories used for the precast beam-to-column connections.

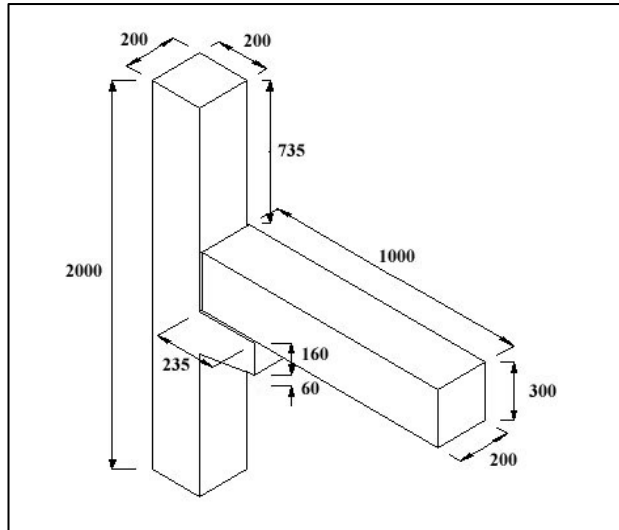

Figure 3 Geometry and dimension of precast beam-to-column connection

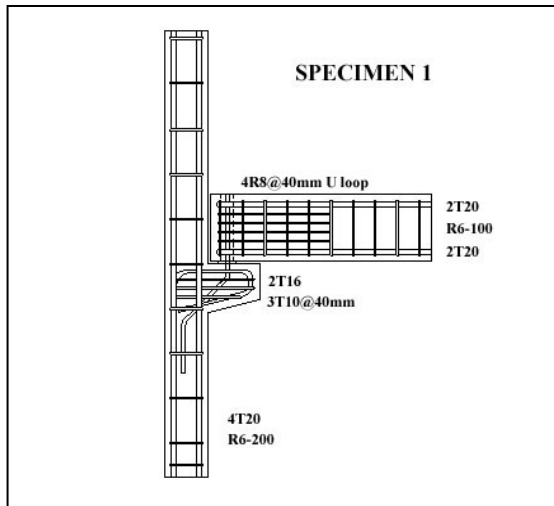

Figure 4 Detailing of specimen 1

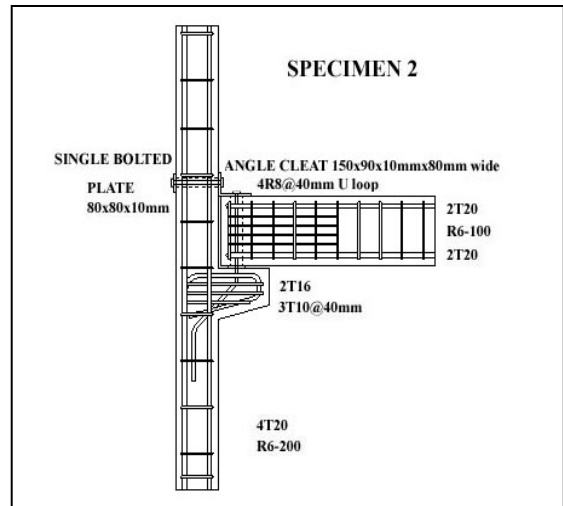

Figure 5 Detailing of specimen 2

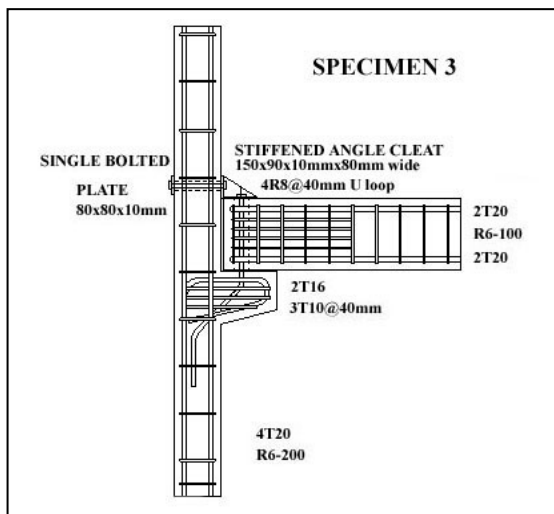

Figure 6 Detailing of specimen 3

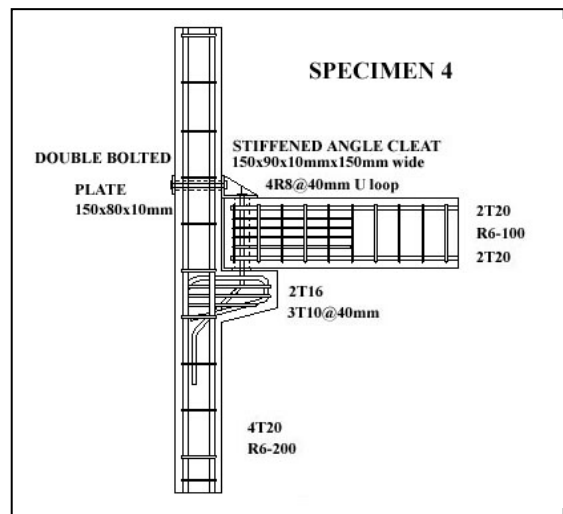

Figure 7 Detailing of specimen 4



Figure 8 Preparation of precast column with corbel (specimen 4): formwork preparation, concrete casting, curing and the completed specimen (from left, clockwise)



Figure 9 Precast column complete with corbel, projecting dowel bar and two sleeves for precast beam-to-column connection (specimen 4)



Figure 10 Preparation of precast concrete beams with sleeve: formwork preparation, concrete casting, curing and the completed specimen (from left, clockwise)



Figure 11 Preparation of sleeve in precast beam



Figure 12 Steel connectors to join the precast beam and column: bolts with nuts, angle cleat, stiffened angle cleats, plates (from left, clockwise)

Test Setup

The beam-to-column connection tests were conducted using Magnus frame as shown in Figure 13. The precast column was restrained at both top and bottom supports. Then, the precast beam was connected to the precast column. During testing, incremental loads were applied on precast beam at a distance of 900mm from the column face to produce moment at the connection. The equipment used consisted of inclinometer to measure inclination of precast beam, displacement transducer (LVDT) to measure displacement of precast beam and column, and data logger to record incremental load and displacement values.

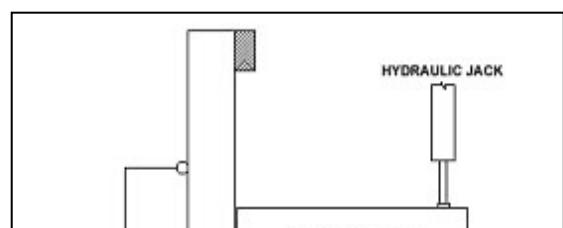



Figure 13 Typical experimental setup

5. Results

In this paper only the behaviour of specimen 1 (see Figure 14) is discussed. The first specimen successfully modelled the almost perfectly pinned connection. It is seen that under beam self-weight, the beam end rotated easily. The axis of rotation was observed at the interface between dowel bar and top rubber bearing. After rotation due to beam self weight, the connection rotated further under incremental applied loads. Based on the LVDT readings at column face, no column rotation was observed. Hence, in this case, the connection rotation is equal to the beam end rotation.

In term of cracking, no cracks or concrete crushing was observed at the column face and beam. The cracking was only observed in the corbel. The test was stopped when excessive cracks and splitting of concrete were found at the corbel. This response reflects that the beam load is transferred to the column in terms of shear force. Figure 15 shows the response of moment-rotation of the connection. For connection rotation of less than 20 milliradians, the moment resistance developed at the connection is less than 2 kNm with a significantly small rotational stiffness (i.e. the slope of the moment-rotation curve). However, the connection exhibits ductile behaviour as it has the ability to rotate greater than 20mm radians. This response shows that the connection failure is a ductile and has minimum risk of any sudden failure. The connection can be classified as pinned for the purpose of analysis and design of precast concrete frame.

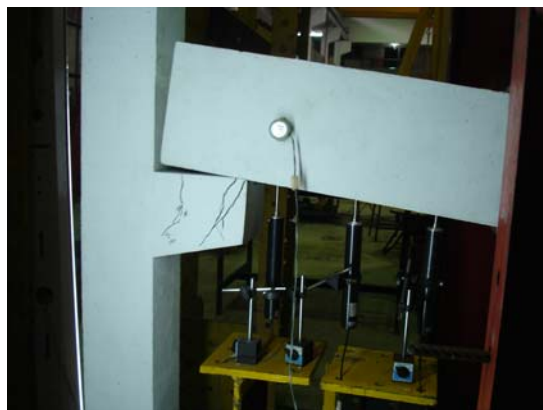

Figure 14: Pinned precast concrete beam-to-column connection

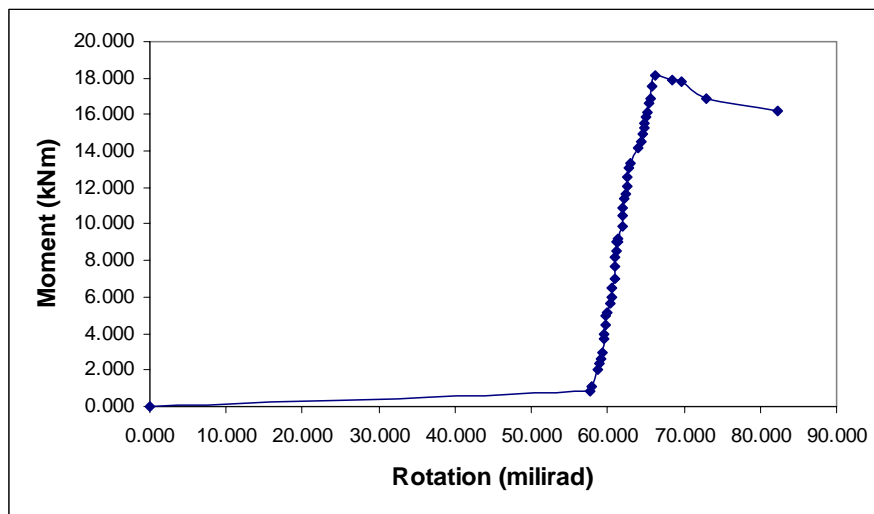

Figure 15 Response of moment-rotation of the precast connection

6. Conclusion

Based on the test results, the following conclusions can be drawn:

1. Simple connection with single dowel and grouted beam-to-column connection provides very minimum moment resistance and hence the connection can be best modelled as pinned. Therefore, in the case of analysis of global frame, the stiffness of such connection is negligible and can be ignored.
2. The single dowel grouted connection can be employed in precast concrete construction and in order to maintain the frame stability, the stiffness of the global frame is provided by other lateral stability systems such as bracing, core or shear wall.

7. Acknowledgement

The authors would like to thank Construction Industry Development Board (CIDB) for funding of the research and Universiti Teknologi Malaysia (UTM) for providing laboratory facilities and assistance.

8. References

- [1] Seckin M. and Fu H.C. (1990). "Beam-Column Connections in Precast Reinforced Concrete Construction." ACI Structural Journal 1990, V87 No.3, pp252-261.
- [2] Loo Y.C. and Yao B.Z.(1995). "Static and Repeated Load Tests on Precast Concrete Beam-to-Column
- [3] Dolan C.W., Stanton J.F. and Anderson R.G.(1987). "Moment Resistance Connections and Simple Connections." PCI Journal 1987, V32 No.2, pp64-74.
- [4] Elliot K.S.(1996). "Multi-Storey Precast Concrete Framed Structures." United Kingdom: Blackwell Science Ltd.

- [5] Elliot K.S, Davies G., Gorgun H., Mohammad Reza A. (1998).“ The Stability of Precast Concrete Skeletal Structures.” PCI Journal 1998, V43 No.2, pp42-61.
- [6] Farah Nora Aznieta Abd.Aziz, Abang Abdullah Abg. Ali, Mohd Saleh Jaafar, Abdul Aziz Abd. Samad and D.N. Trikha (2004). “ Ultimate Strength of Precast Concrete Sandwich Panel with Opening Under Axial Load.” Journal- The Institution of Engineers, Malaysia, Vol.65, No.1/2, March/June 2004,pp 8.