

DEPTH CONTROL OF AN UNDERWATER REMOTELY OPERATED VEHICLE USING NEURAL NETWORK PREDICTIVE CONTROL

Mohd Shahrieel Mohd Aras^{a*}, Shahrum Shah Abdullah^b, Ahmad Fadzi Nizam Abdul Rahman^c, Norhaslinda Hasim^d, Fadilah Abdul Azis^a, Lim Wee Teck^a, Arfah Syahida Mohd Nor^a

^aUnderwater Technology Research Group (UTeRG), Faculty of Electrical Engineering, Universiti Teknikal Malaysia Melaka, Hang Tuah Jaya, 76100 Durian Tunggal, Melaka Malaysia

^bDepartment of Electric and Electronics, Malaysia-Japan International Institute of Technology, Universiti Teknologi Malaysia, International Campus Jalan Semarak, 54100 Kuala Lumpur, Malaysia

^cFaculty of Information and Computer Engineering, Universiti Teknikal Malaysia Melaka, Hang Tuah Jaya, 76100 Durian Tunggal, Melaka Malaysia

^dDepartment of Control, Instrument and Automation, Faculty of Electrical Engineering, Universiti Teknikal Malaysia Melaka, Hang Tuah Jaya, 76100 Durian Tunggal, Melaka Malaysia

Article history

Received

13 March 2015

Received in revised form

14 April 2015

Accepted

15 June 2015

*Corresponding author
shahrieel@utem.edu.my

Graphical abstract

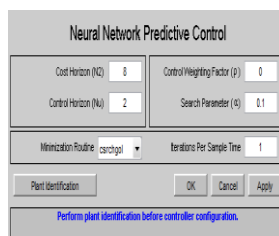

Abstract

This paper investigates the depth control of an unmanned underwater remotely operated vehicle (ROV) using neural network predictive control (NNPC). The NNPC is applied to control the depth of the ROV to improve the performances of system response in terms of overshoot. To assess the viability of the method, the system was simulated using MATLAB/Simulink by neural network predictive control toolbox. In this paper also investigates the number of data samples (1000, 5000 and 10,000) to train neural network. The simulation reveals that the NNPC has the better performance in terms of its response, but the execution time will be increased. The comparison between other controller such as conventional PI controller, Linear Quadratic Regulation (LQR) and fuzzy logic controller also covered in this paper where the main advantage of NNPC is the fastest system response on depth control.

Keywords: Depth control, unmanned underwater remotely operated vehicle, neural network predictive control

Abstrak

Kertas kerja ini mengkaji kawalan kedalaman bagi kenderaan bawah air kawalan jauh tanpa pemandu (ROV) menggunakan kawalan ramalan rangkaian neural (NNPC). The NNPC digunakan untuk mengawal kedalaman ROV untuk meningkatkan prestasi sistem tindak balas dari segi lajakan. Untuk menilai kaedah daya maju, sistem itu menggunakan simulasi MATLAB / Simulink oleh kawalan ramalan rangkaian neural kotak-alatan. Dalam kertas kerja ini juga menyiasat bilangan sampel data (1000, 5000 dan 10,000) untuk melatih rangkaian neural. Simulasi ini menunjukkan bahawa NNPC mempunyai prestasi yang lebih baik dari segi lajakan, tetapi masa pelaksanaan yang akan bertambah. Perbandingan

antara pengawal lain seperti pengawal konvensional PI, Linear kuadratik Peraturan (LQR) dan juga pengawal logik kabur di dalam artikel ini di mana kelebihan utama NNPC adalah tindak balas sistem terpantas bagi kawalan mendalam.

Kata kunci: kawalan kedalaman, kenderaan bawah air kawalan jauh tanpa pemandu, kawalan ramalan rangkaian neural

© 2015 Penerbit UTM Press. All rights reserved

1.0 INTRODUCTION

The neural network predictive control is considered as a basic type of model based predictive system which is the model is a trained neural network using neural network toolbox in MATLAB as shown in Figure 1. It consists of four components (i.e. the plant to be controlled, the desired performance of the plant, a neural network that models the plant, and an optimization process that determines the optimal inputs needed to produce the desired performance for the plant) [1]. The neural network predictive control normally optimizes the plant responses over a specified time horizon [2-3]. The role of neural network model predictor, which uses the error e between the system output y_p and the neural network model output y_m , as neural network training signal. The nonlinear neural network model is to predict the future performance, determine the control signal u by minimizing cost function, J as in Equation (1) [4]. The steps of the neural network predictive algorithm as shown in Figure 2.

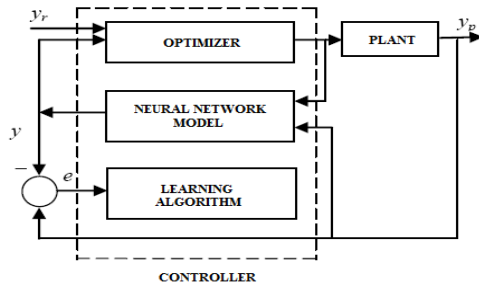

Figure 1 Block diagram of neural network predictive control system [1]

Neural network predictive control is a control method that finds the control input by optimizing a cost function subject to constraint. The cost function used to calculate the desired control signal by using a model of the plant to predict future plant output [5-6]. A fundamental part of this method is the actual optimization problem that obtains future control inputs by minimizing a cost function subject to constraints on the system. Typically, the cost function, J consists of the error between the reference trajectory r and the predicted outputs y in addition to the control effort, u . A.S.M Nor et al. using NNPS for control deep submergence rescue vehicle (DSRV)

[1]. In [7-8] used the DSRV model to design an intelligent controller that called single input fuzzy logic controller. Based on [1], the NNPC will be used to control the ROV that was developed by Underwater Technology Research Group (UTeRG) from faculty of electrical engineering Universiti Teknikal Malaysia Melaka. The model of ROV obtained from system identification technique as can be referred to [9-11]. The parameter for NNPC almost the same just varied on number of data samples (e.g. 1000, 5000 and 10,000).

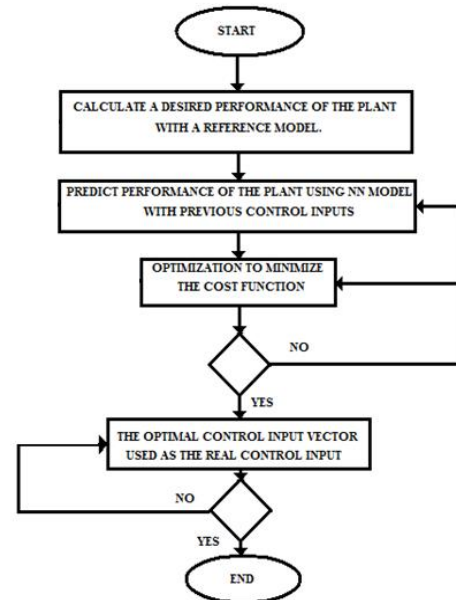

Figure 2 Steps of the neural network predictive algorithm

$$J = \sum_{j=N_1}^{N_2} [y_r(k+H_p) - y_m(k+H_p)]^2 + \rho \sum_{j=1}^{N_u} [u(k+H_p-1) - u(k+H_p-2)]^2 \quad (1)$$

where:

N_1 = the minimum costing horizon

N_2 = the maximum costing horizon

N_u = the control horizon

y_m = predicted output of the neural network

y_r = reference trajectory

ρ = the control input weighting factor.

u = reference trajectory u is control signal

2.0 THE MODELLING OF ROV USING SYSTEM IDENTIFICATION

As mention previous the modeling of the ROV using system identification method. The ROV was developed by UTerg Group as shown in Figure 3-5. The focused on depth control only. Experiment on an open loop system was done on the ROV for depth control with set point at 3 m in a swimming pool using NI USB-6009 data acquisition card and multi-meter. At least two experiments were considered. Based on Figure 6, set point will be represented as x , Exp 1 and Exp 2 is represented as y and y_1 , respectively. Where x , y and y_1 where the input and outputs of the system, respectively.

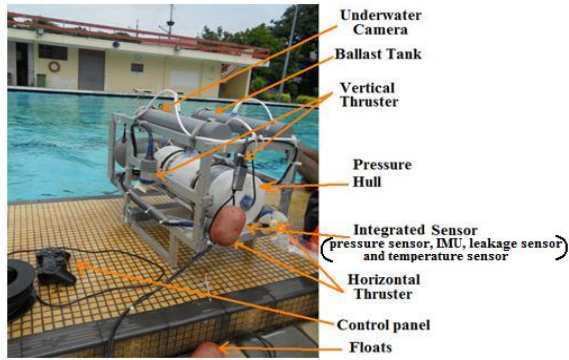

Figure 3 Components of the ROV and integrated sensor

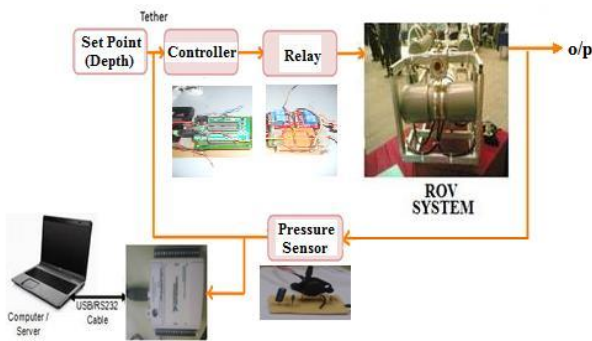

Figure 4 ROV's system for depth control

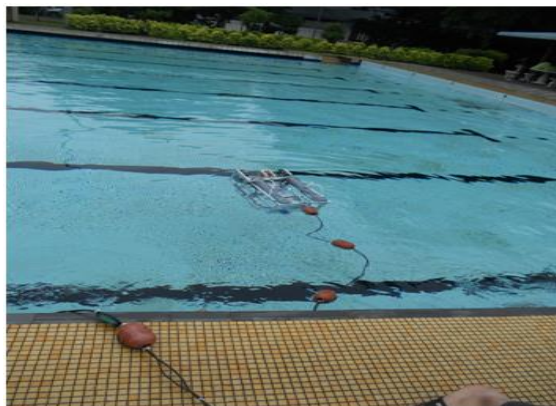

Figure 5: ROV tested in the swimming pool

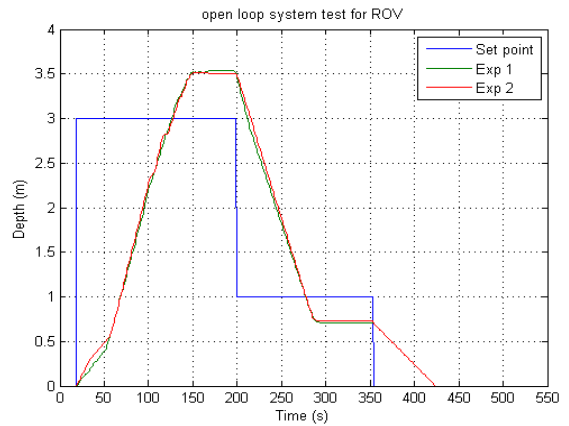

Figure 6 Experiment results testing open loop system for the ROV

Normally, the red colour is the default choice as shown in Figure 7. For infer the ROV modelling, third order was selected. The best fits of the measured and simulated model output were 89.46%. A model output window shown in Figure 8 was displayed. Percent best fit value displayed in the best fits window.

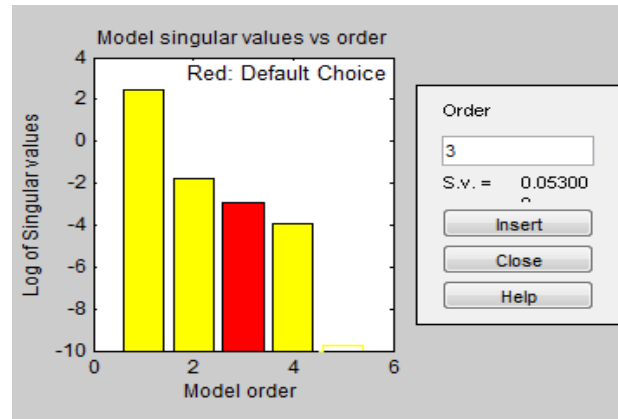

Figure 7 Model singular values vs. order

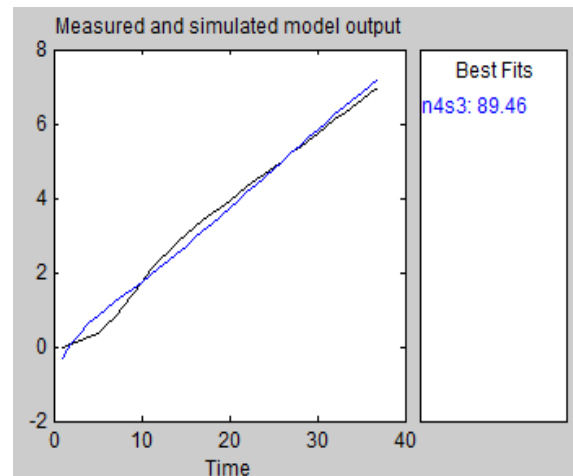

Figure 8 Measured and simulated model output

Transfer function state space technique yields:

$$TF = \frac{0.4871s^2 + 1.37s + 67.31}{s^3 + 4.911s^2 + 8.309s + 76.09} = \frac{\text{voltage (depth)}}{\text{Voltage to thruster (V)}} \quad (2)$$

And the ROV system also can be written as continuous time-invariant as in Equation (3) and (4). By using MATLAB® command transfer function equation can change to state-space model as written in Equation (5).

$$\dot{x}(t) = Ax(t) + Bu(t) \quad (3)$$

$$y(t) = Cx(t) + Du(t) \quad (4)$$

$$\dot{x}(t) = \begin{bmatrix} -5.835 & -9.826 & -0.6262 \\ -285.8 & -159.3 & 588.9 \\ 286.8 & 87.12 & -326 \end{bmatrix} x(t) + \begin{bmatrix} 3.621 \\ -105.8 \\ 38.18 \end{bmatrix} u(t) \quad (5)$$

$$y(t) = [5.358 \quad 0.1272 \quad -0.02792]x(t)$$

The model obtained from system identification technique will be analysed in terms of controllability and observability and also asymptotically stable. Based on Equation (5), the system is both controllable and observable because the system has a rank of 3. This system is asymptotically stable when all eigenvalues of A have negative real parts. Figure 9 shows the block diagram Neural Network Predictive Control for control the depth of the ROV based on model obtained using system identification technique.

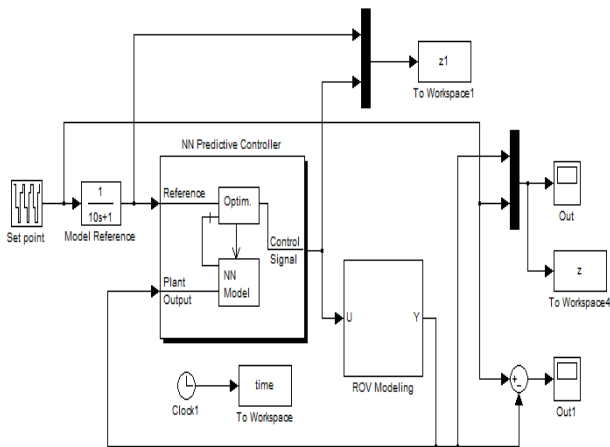
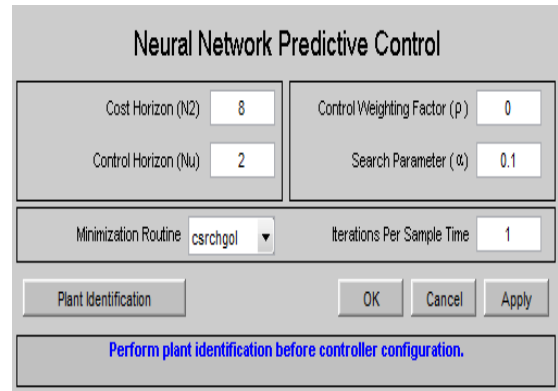

Figure 9 Block Diagram Neural Network Predictive Control for the ROV

3.0 NEURAL NETWORK PREDICTIVE CONTROL (NNPC)

This section illustrates a simple way of controlling a nonlinear and 4th order system using neural network

predictive control. The design procedure utilizes MATLAB® Neural Network Predictive Control toolbox and was implemented using SIMULINK® version 7.6. A Neural Network Predictive Control (NNPC) was designed to control the ROV as shown in Figure 10. A neural network was designed to be used as the predictive model of the MPC. The NNPC will then be compared with conventional controllers such as PI, fuzzy logic Controller, and Observer-LQR controllers to determine its performance and characteristics. Control design methods based on MPC was found to be widely used in many industrial applications [12]. The ability of MPC in handling constraints contributes to a significant advantage in a context of the overall operating objectives of many process industries. The optimization determines the control signal that optimizes plant behaviour over the time horizon [13]. Figure 10 shows the window for designing the model predictive controller.



(a) Neural Network Predictive Control

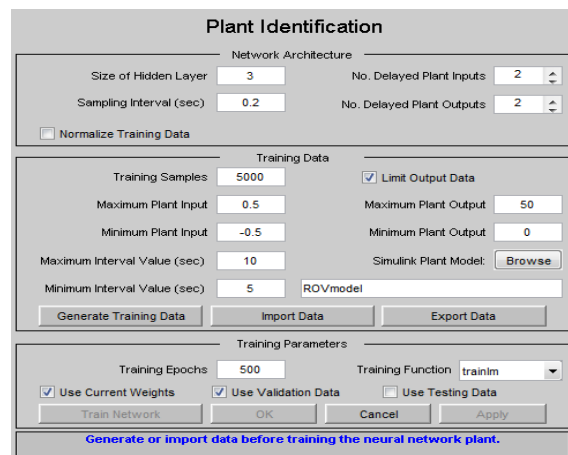

(b) Plant Identification

Figure 10 Neural Network Predictive Control Block

4.0 RESULT AND ANALYSIS

Figure 11 shows the input and output of the system based on 5000 data samples. This input and output system based on model ROV that used for open loop

system. Figure 12 shows then validation data and training data for NN Predictive Control based on 5000 data samples. Figure 13 shows the input and output of the system based on 1000 data samples based on open loop model ROV. Figure 14 shows the validation data and training data for NN Predictive Control based on 1000 data samples. Figure 15 shows the Neural Network toolbox in MATLAB. From this figure the number of layer for NN can be seen and also the progress of neural network performances can be obtained as shown in Figure 16 until Figure 18.

The results based on three data samples (e.g. 1000, 5000, 10,000) as shown in Figure 19. Figure 19 shows the results for each data samples, respectively. Based on this results, the number of data samples doesn't not affected the performances of NNPC. The results of three data samples is almost the same. Figure 20 shows the different set point based on the best data samples (5000 data samples).

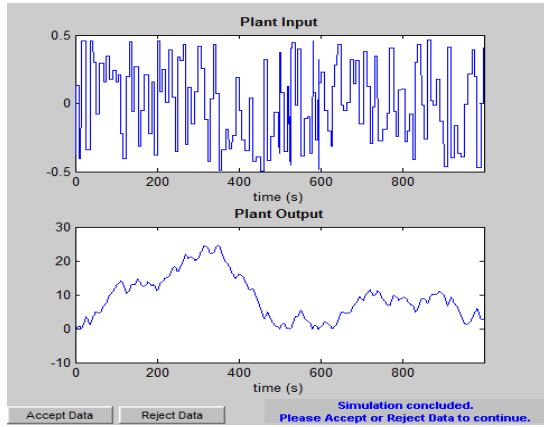
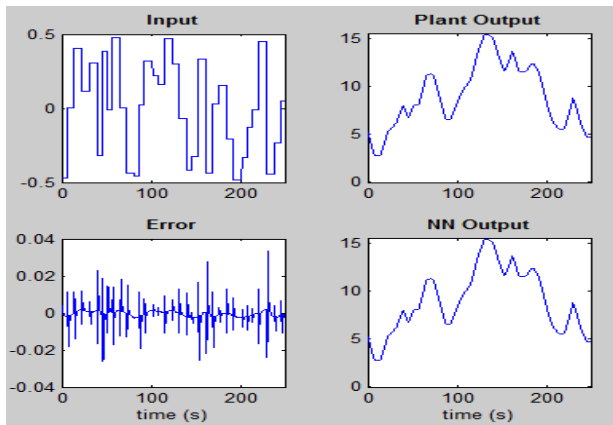
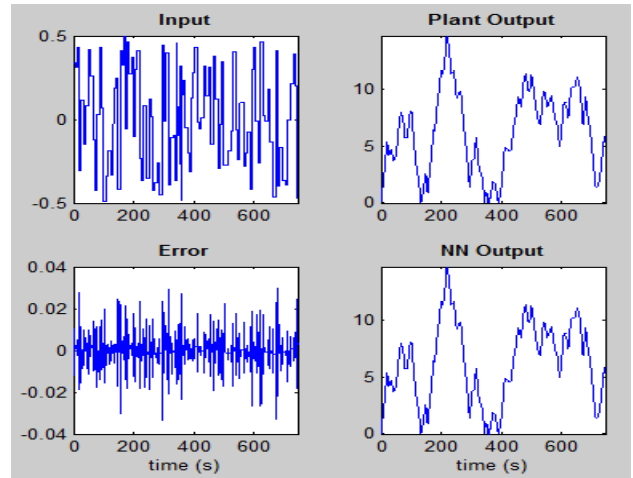

Figure 11 Input and Output of the system based on 5000 data samples



(a)



(b)

Figure 12 Validation data and Training Data for NN Predictive Control for 5000 data samples

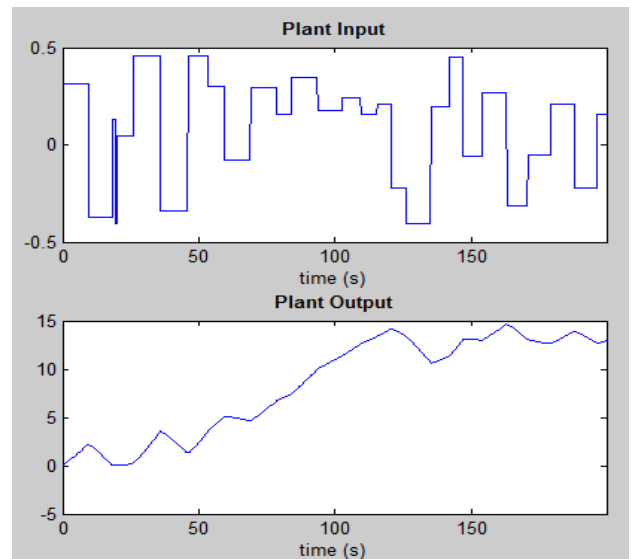
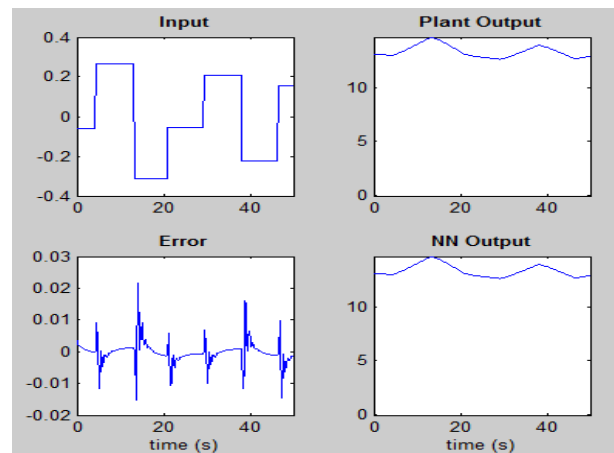
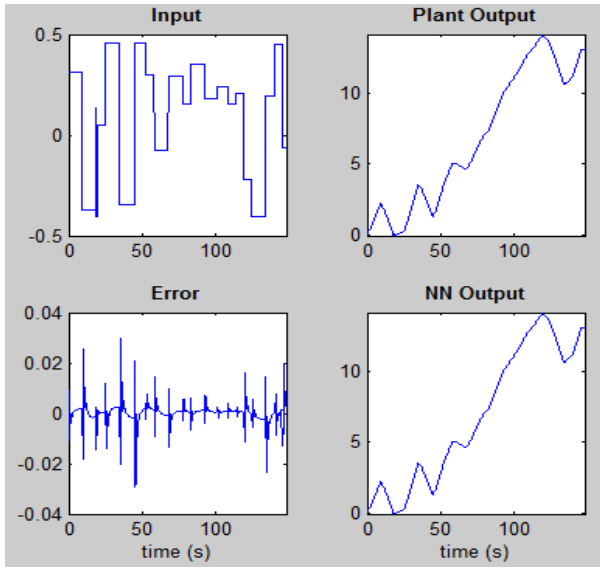

Figure 13 Input and Output of 1000 data samples



(a) Validation



(b) Training

Figure 14 Validation data and Training Data for NN Predictive Control for 1000 data samples

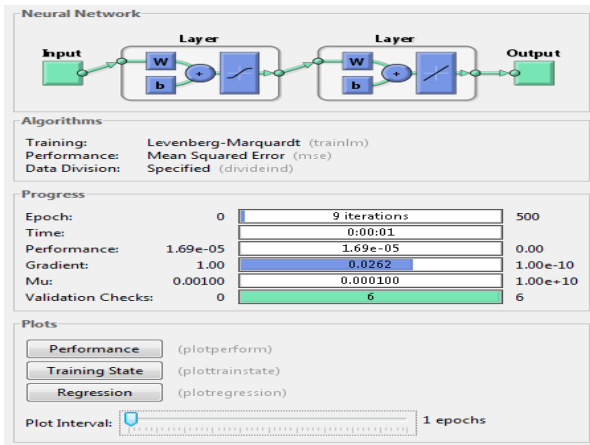

Figure 15 Neural Network Toolbox

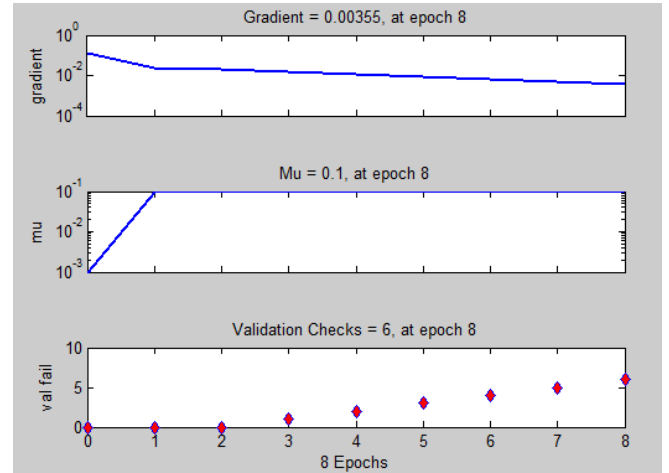

Figure 17 Time for Training state

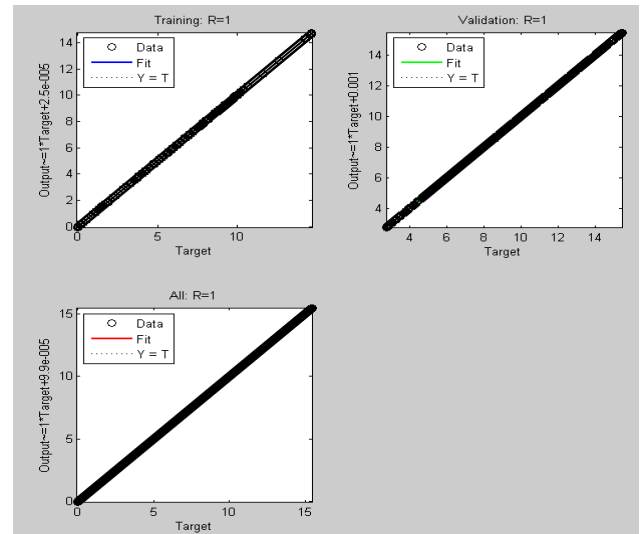

Figure 18 Regression

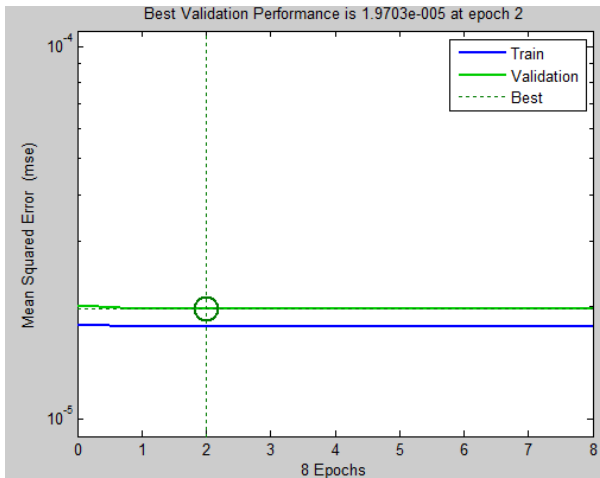
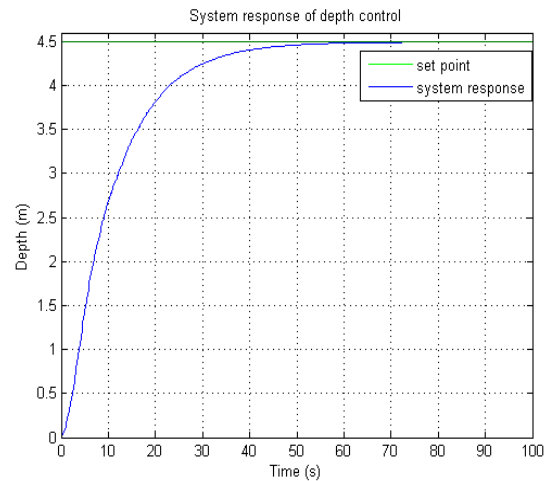
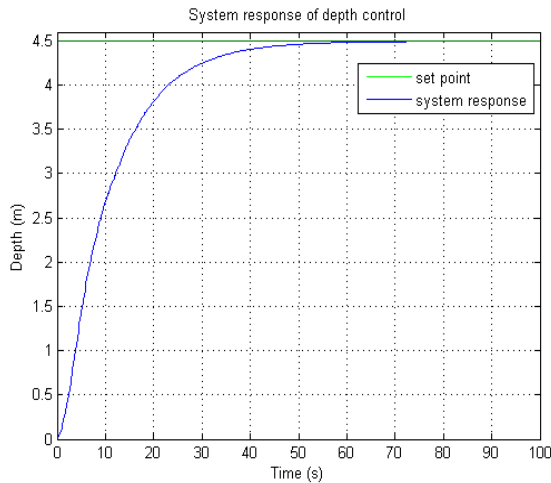

Figure 16 Best Validation Performances



10,000 data samples



5000 data samples

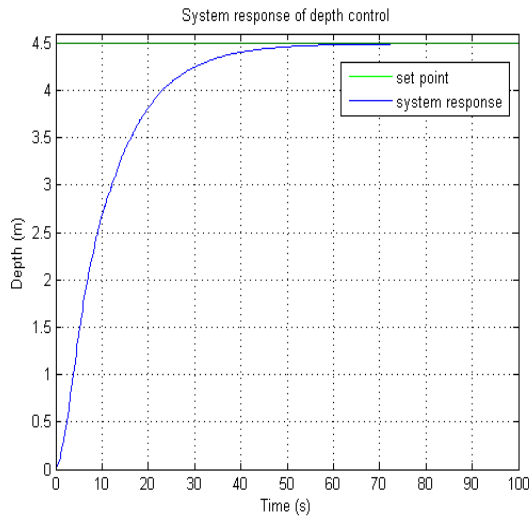

1000 data samples

Figure 19 System response of depth control

4.1 Controller Comparison

Comparison is made on the response with other controllers (e.g. PI controller, FLC controller, and Observer based on output feedback control). Figure 10 shows all simulation system response results for ROV vertical trajectory. The set point is varied for a given time of 100 seconds. The simulation shows that, all five controllers give a zero steady-state error and zero overshoot. However, neural network predictive control gives a better performance in terms of the transient response. As can be seen in Figure 21, neural network predictive control gives a faster settling time and rise time, followed by Observer-LQR, PI controller, and FLC controller. The simulation results expressed the steady-state performance. The steady-state performance indexes are summarized in Table 1. From the table, the depth response of the neural network predictive control achieved a better

transient and steady-state performance than an improved SIFLC, Observer-LQR, PI controller, and SIFLC. An advantage of an improved SIFLC over other controllers is, the simulation time, which is the time required to compute the simulation. Table 2 shows the comparison of computational time between the neural network predictive controller, LQR controller, PI controller, SIFLC and an improved SIFLC. It can be observed that an improved SIFLC has faster than other controllers and neural network predictive controller is the slowest among them. The NNPC cannot meet the requirement of rapid response. Here it can conclude that an NNPC is better for the system need accuracy and precision task where the task doesn't care about computational time. The reason is why NNPC more suitable for forecasting and prediction application. For underwater application, NNPC more suitable for recognition of images on underwater and prediction of underwater environments where the important issues should be covered when implemented in real time system especially in the ocean. The research of NNPC is not end, because a lot of parameter can be studied to give better results (e.g. Neural Network predictive Block). To many parameter can be changes to improved the performances of system response.

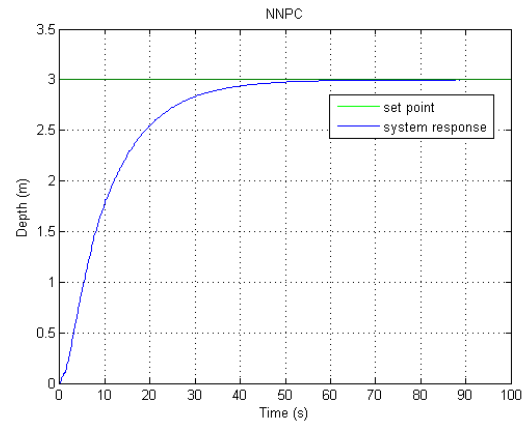

(a)

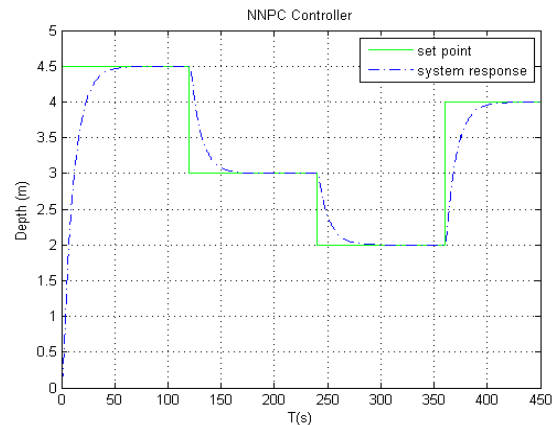

(b)

Figure 20 Neural Network Predictive Controller system response

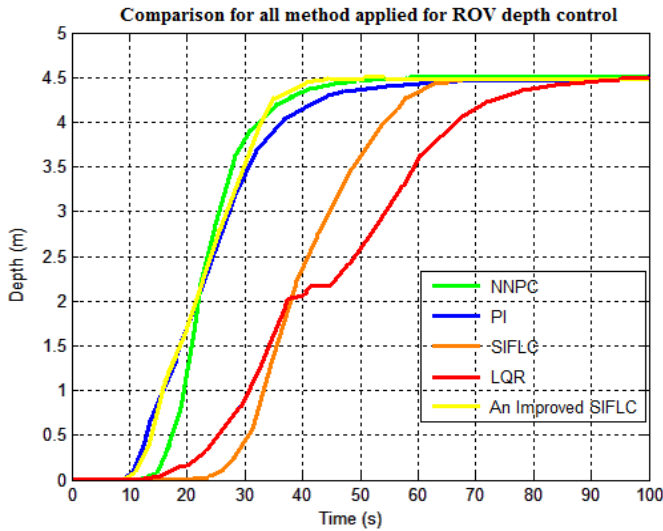

Figure 21 Comparison for all method applied for ROV depth control

Table 1 Comparison controller techniques for depth control

	SIFLC	PI	NNPC	Observer-LQR	Improved SIFLC
Peak Time, T_p (s)	100	80	65	75	70
Rise Time, T_r (s)	90	70	50	70	60
Settling Time, T_s (s)	110	80	65	75	70
Overshoot (%)	0.1	0.1	0.1	0.7	0
Steady state error	0	0	0	0.2	0

Table 2 Simulation Time

Controller Method	Computation time
NNPC	212.5 s
PI	0.29 s
SIFLC	0.322 s
Observer- LQR	0.3 s
Improved SIFLC	0.29 s

5.0 CONCLUSION

The NNPC is applied to control the depth of the ROV. The system was simulated using MATLAB/Simulink and NNPC toolbox. The simulation reveals that the NNPC has the better performance, and it exactly resembles an improved SIFLC in terms of its response, but the execution time will be higher than others. The main advantage of NNPC is the fastest system response on depth control but execution time for simulation take

longer time. A lot of parameter can be studied to give better results (i.e. Neural Network predictive Block) where many parameters can be changes to improve the performances of system response. For future recommendation applied this NNPC to real time system by using Micro-box 2000/2000C where Micro-box 2000/2000C is an XPC target machine device to interface between an ROV with the MATLAB 2009 software.

Acknowledgement

We wish to express our gratitude to honorable University, Universiti Teknikal Malaysia Melaka (UTeM) and Universiti Teknologi Malaysia (UTM) especially for Underwater Technology Research Group (UTeRG), Centre of Research and Innovation Management (CRIM) and to both Faculty of Electrical Engineering from UTeM and UTM to give the financial as well as moral support for complete this project successfully.

References

- [1] Nor, A. S. M. Abdullah, S. S. Aras, M. S. M. and Rashid A.. 2012. Neural Network Predictive Control (NNPC) of a Deep Submergence Rescue Vehicle (DSRV). *4th International Conference on Underwater System Technology: Theory and Applications 2012 (USYS'12)*. 24-29.
- [2] Zeng, G. M. Qin, X. S. He, L. Huang, G. H. Liu H. L. and Lin. Y. P. 2003. A Neural Network Predictive Control System for Paper Mill Wastewater Treatment. *Engineering Applications of Artificial Intelligence*. 16: 121-129.
- [3] Kodogiannis, V. S. Lisboa P. J. G. and Lucas. J. 1994. Neural Network Based Predictive Control Systems For Underwater Robotic Vehicles. *International Conference Proceedings*. 369-376.
- [4] Maciejowski, Jan M. 2002. *Predictive Control: With Constraints*. Harlow England: Prentice Hall.
- [5] Caldwell, C. V. Collins, E. G. and Palanki. S. 2006. Integrated Guidance and Control of AUVs Using Shrinking Horizon Model Predictive Control. *IEEE Conference Publications*. 1-6.
- [6] Donald Soloway and Pamela J. Haley. 1996. Neural Generalized Predictive Control. *IEEE International Symposium on Intelligent Control*. 1-6.
- [7] Kashif Ishaque, Abdullah S. S., Ayob S. M. and Salam Z. 2010. Single Input Fuzzy Logic Controller for Unmanned Underwater Vehicle. *Journal of Intelligent and Robotic Systems*. 59(1).
- [8] Ishaque, K. Abdullah, S. S. Ayob S. M. and Salam. Z. 2010. A Simplified Approach to Design Fuzzy Logic Controller for an Underwater Vehicle. Faculty of Electrical Engineering, Universiti Teknologi Malaysia.
- [9] Mohd Shahrivel Mohd Aras, Shahrum Shah Abdullah, Azhan Ab Rahman and Muhammad Azhar Abd Aziz. 2013. Thruster Modelling for Underwater Vehicle Using System Identification Method. *International Journal of Advanced Robotic Systems*. 10(252): 1-12.
- [10] Aras, M. S. M, S. S. Abdullah, Rashid, M. Z. A, Rahman, A. Ab and Aziz, M. A. A. 2013. Development and Modeling of underwater Remotely Operated Vehicle using System Identification for Depth Control. *Journal of Theoretical and Applied Information Technology*. 56(1): 136-145.
- [11] Mohd Aras, Mohd Shahrivel and Abdul Rahman, Ahmad Fadzli Nizam. 2013. Analysis of an Improved Single Input Fuzzy Logic Controller Designed For Depth Control Using

Microbox 2000/2000c Interfacing. *International Review of Automatic Control*. 6(6): 728-733.

- [12] Yang Shi, Weiqi Qian, Weisheng Yan and Jun Li. 2007. Adaptive Depth Control for Autonomous Underwater Vehicles Based on Feedforward Neural Networks. *International Journal of Computer Science & Applications*

2007 Technomathematics Research Foundation. 4(3): 107-118.

- [13] Garcia, C. E. 1989. Model Predictive Control: Theory and Practice-A Survey. *Automatica*.