

STUDY ON THE EFFECT OF SHIFTING 'ZERO' IN OUTPUT MEMBERSHIP FUNCTION ON FUZZY LOGIC CONTROLLER OF THE ROV USING MICRO-BOX INTERFACING

Article history

Received

13 March 2015

Received in revised form

14 April 2015

Accepted

15 June 2015

Mohd Shahrieel Mohd Aras^{a*}, Fadilah Abdul Azis^a, Shahrum Shah Abdullah^b, Lee Dai Cong^a, Lim Wee Teck^a, Fara Ashikin Ali^c, Muhammad Nur Othman^c

*Corresponding author
shahrieel@utem.edu.my

^aUnderwater Technology Research Group (UTeRG), Faculty of Electrical Engineering, Universiti Teknikal Malaysia Melaka, Hang Tuah Jaya, 76100 Durian Tunggal, Melaka, Malaysia

^bDepartment of Electric and Electronics, Malaysia-Japan International Institute of Technology, Universiti Teknologi Malaysia, International Campus Jalan Semarak, 54100 Kuala Lumpur, Malaysia

^cDepartment of Mechanical, Faculty of Technology Engineering, Universiti Teknikal Malaysia Melaka, Hang Tuah Jaya, 76100 Durian Tunggal, Melaka, Malaysia

Graphical abstract



Abstract

This paper investigates the study on the effect of shifting 'zero' membership function on Fuzzy Logic Controller (FLC) design of underwater Remotely Operated Vehicle (ROV) for depth control using Micro-box 2000/2000C interfacing based on thruster system. The issues occurred with a ROV design is where the thruster system can easily drain up current from the supply (e.g. battery source or power bank) and this will limit time to using the ROV. FLC do not have a rigid approach to tune it and may cause the process of tuning will be highly time costing. Therefore, a simple method by a study on the effect of shifting zero membership function will act as a one technique to tune the FLC for future references. The ROV Trainer will be developed to test the proposed control method using Micro-box 2000/2000C. The ROV Trainer consists of aluminum box, thrusters, drivers, interface connector, and etc and interfacing with Micro-box act as microcontroller. Fuzzy logic toolbox in MATLAB will be used to study the shifting zero membership function so that the effect of the adjustment can be investigated. The result of this project shows that, by shifting zero membership function of the fuzzy logic controller, the performance of the fuzzy logic controller is normally improved.

Keywords: Depth control, underwater remotely operated vehicle, fuzzy logic controller, microbox 2000/2000C, thruster system

Abstrak

Kertas kerja ini mengkaji ke atas kesan peralihan fungsi keahlian 'sifar' pada Pengawal Logik Kabur (FLC) bagi Kenderaan Kawalan Jauh dalam air (ROV) untuk mengawal kedalaman menggunakan perantaraan Microbox 2000 / 2000C berdasarkan sistem tujahan. Isu yang timbul bagi mereka bentuk ROV adalah di mana sistem tujahan yang boleh bekerja sehingga sekarang daripada pembekalan (contohnya dari sumber bateri atau bank kuasa) dan ini akan menghadkan masa untuk menggunakan ROV. FLC tidak

mempunyai pendekatan yang tegar dan boleh menyebabkan proses penalaan akan mengambil masa yang lama. Oleh itu, satu kaedah yang mudah oleh kajian mengenai kesan peralihan fungsi keahlian sifar yang akan bertindak sebagai satu teknik untuk menala FLC untuk rujukan masa depan. *ROV Trainer* akan dibangunkan untuk menguji kaedah kawalan yang dicadangkan menggunakan Microbox 2000 / 2000C. *ROV Trainer* terdiri daripada kotak aluminium, penujah, pemandu, pengantaraan, dan lain-lain dan antara pengantaraan dengan Microbox sebagai pengawal mikro. Kotak-alat logik kabur dalam MATLAB akan digunakan untuk mengkaji fungsi keahlian sifar yang beralih supaya kesan pelarasan boleh disiasat. Hasil projek ini menunjukkan bahawa, dengan peralihan fungsi keahlian sifar pengawal logik kabur, prestasi pengawal logik kabur biasanya bertambah baik.

Kata kunci: Kawalan dalaman, kenderaan kawalan jauh dalam air, pengawal logik kabur, microbox 2000 / 2000C, sistem tujahan

© 2015 Penerbit UTM Press. All rights reserved

1.0 INTRODUCTION

ROV is one of the underwater unmanned vehicles where its main purpose is to observe underwater conditions and perform underwater operations where divers cannot reach. ROVs are highly implemented in offshore underwater operations by oil and gas companies and scientists whose main purpose is to do research and exploration of underwater knowledge [1]. In addition, ROV is also being used for black box searching for the famous MH370 mysterious incident. Without ROV, it was never possible for the search of black box to be carried out because the weather of the deep water sea is highly vicious and sending in human for the operation is considered unrealistic [2-5]. Nevertheless, the importance of ROV is highly underrated as it never received high public appreciation. The development of fuzzy logic controllers is considered an aged approach for control systems, but because there are no accurate ways to tune it adequately, a simple technique to tune FLC will be introduced [6]. Thus, this research is carried out to design an intelligent controller for depth control of ROV using Micro-box 2000/2000C interfacing almost similar in [7]. This study will be focused on how zero output membership function affects the result matters.

The conventional control system for the ROV which is a PID controller cannot function well when it is in the underwater environment. This is due to conventional PID controllers do not suitably work with non-linear environments [8-9]. Because it is crucial for ROV to not contact with the seabed which might cause damage to the remotely operated underwater vehicle, the control system of it should have minimum overshoot and it can hardly be done by the conventional PID controller. Thus, intelligent control systems such as fuzzy logic controllers are needed in order to solve this problem but fuzzy logic controllers are considered complicated because there are no specific ways to tune them. Trial and error is the common approach to do this and it often results in a great waste of time [10-11]. Therefore, a simple overview

on how zero output membership function of the fuzzy logic can affect the results becomes one simple contribution for this field of study.

This project will be carried out in a controlled environment where the environment disturbance will be assumed to be zero. For this limitation, a *ROV Trainer* is built for testing the proposed control system before implemented in real time operation. This *ROV Trainer* was built mainly to overcome an issue where it is troublesome to carry out the experiments in the water [12]. Since the project is about depth control, the vertical thrusters system for up and down movement will be considered throughout the project. As this project is mainly about control systems, the paper will only briefly provide information of control systems for ROV. This project will implement the intelligent control system by using Micro-box 2000/2000C. The experiments will be carried out for a depth of 3 meters only as the controller is not robust enough to carry out experiments at different voltages, this is highly due to the reason that a robust fuzzy logic controller will require many membership functions.

2.0 ROV TRAINER

Because of the reason that Micro-box 2000/2000C is very expensive, it is highly undesirable to test it underwater as water leakage may happen to the ROV. Therefore, a *ROV Trainer* will be built to test it [12]. The *Trainer* has a pressure sensor to obtain data of pressure where it will then be converted to depth and the pressure will be provided by a 12V mini air pump through a pressure regulator. Other than that, there will be 4 thrusters with propellers and their drivers attached to the railway on a frame. The railway will be 2 feet long, 2 feet wide and 1 foot tall. A controller module which included the PIC controller, National Instrument DAQ board, and Micro 2000/2000C will also be available as shown in Figure 1 and Figure 2. Figure 1 shows the *ROV trainer*

using solidworks software while Figure 2 shows the actual ROV trainer in different view.

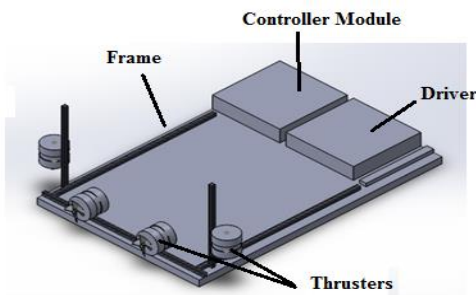
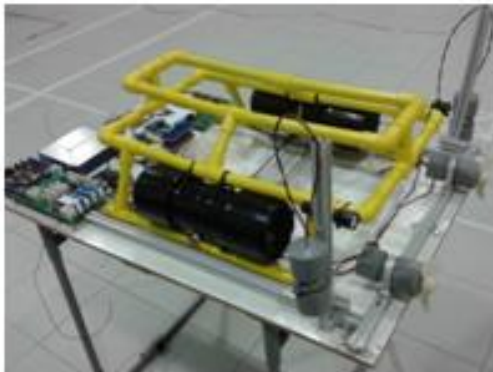

Figure 1 The ROV trainer using solidworks



(a)



(b)

Figure 2 The ROV trainer: (a) front view; (b) isometric view [12]

3.0 HARDWARE

3.1 Pressure Sensor

The definition for pressure is difference when it's come to water pressure. This is because the pressure of water should consider the depth of water and its density [13]. The pressure sensor use in this project is MPX4250GP. This sensor can provide analog output signal and function-able in the water. It is commonly used in automotive field. The MPX4250A/MPXA4250A series, a manifold absolute pressure (MAP) sensor for engine control is designed to sense the absolute air pressure within the intake of the manifold. This

measurement can be used to measure a depth. Pressure sensor used as underwater depth sensor measurement by using MPX4250AP CASE 867B-04 is from Farnell® as shown in Figure 3. Only pin number 1, 2, and 3 were used. The rest were not connected. Figure 4 shows the fully integrated pressure sensor schematic. Based on the schematic, the pressure sensor has a sensing element, thin film temperature compensation and gain stage 1 cascaded with gain stage 2 and ground reference shift circuitry [14].



PIN NUMBERS			
1	V _{out}	4	N/C
2	GND	5	N/C
3	V _s	6	N/C

Figure 3 MPX4250AP CASE 867B-04 with pin configurations

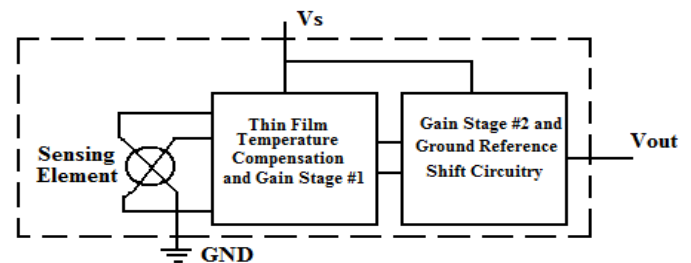

Figure 4 Fully integrated pressure sensor schematic

Figure 5 shows the recommended decoupling circuit for interfacing the output of the integrated sensor to the analog-to-digital, A/D input of a microprocessor or microcontroller. Table 1 shows the operating characteristics [14] ($V_S = 5.1 \text{ VDC}$, $T_A = 25^\circ\text{C}$) unless otherwise noted. Typical, minimum, and maximum output curves are shown for operation over temperature range of 0° to 85°C by using the decoupling circuit shown in Figure 5. The output is saturated outside of the specified pressure range. The measurement unit is in kPa. From the datasheet, the range of pressure sensor measurement is from 20 to 250 kPa or 2.9 to 36.3 psi or 0.2 to 4.9V for output as shown in Figure 6. From this data, it also can convert a depth (output voltage) in meter, and the depth ranges were from 0 to 26 meters.

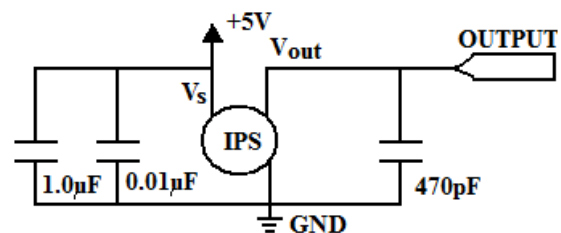

Figure 5 Recommended power supply decoupling and output filtering

Table 1 Operating characteristics [14]

Characteristic	Symbol	Value	Units
Supply Voltage	V_s	5.1	V_{DC}
Full Scale Output $V_s = 5.1\text{ V}$	VFSO	4.896	V_{DC}
Accuracy	-	1.5	%VFSO
Sensitivity	$\Delta V/\Delta P$	20	mV/kPa
Differential Pressure Range	P_{OP}	20 – 250	kPa

(Temperature range from 0 to 85 °C)

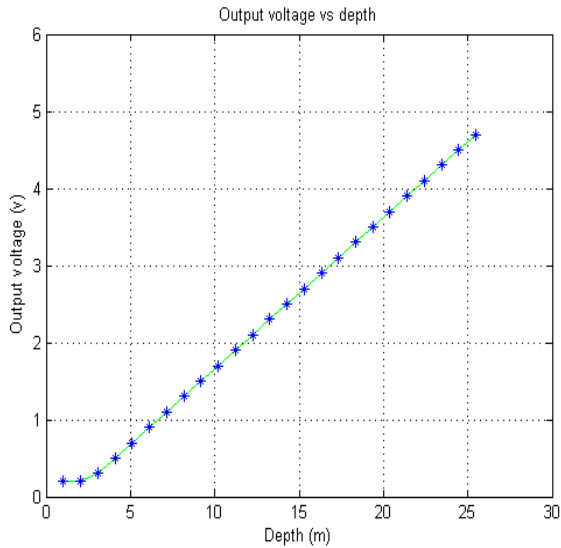

Figure 6 Output voltage vs. depth

3.2 Driver

Driver used in this project is a Single Pole Double Throw type driver as shown in Figure 7. It is basically a relay which works to operate the thruster. A signal is given to the driver to activate the relay and the driver will give the thruster external power source to operate. This is very crucial as thrusters will draw up current to operate. Figure 8 shows the schematics diagram of the driver.

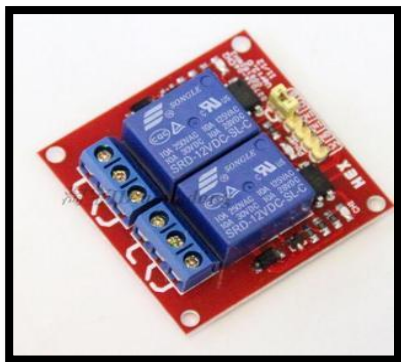

Figure 7 Motor driver

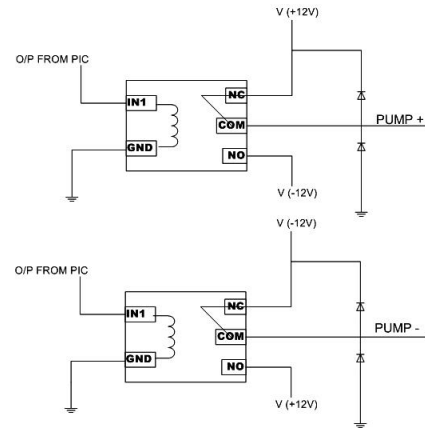

Figure 8 Schematics of driver

3.3 Thruster

The thruster is the kinetic source of the ROV as shown in Figure 9. Without the thruster with its propeller, the ROV cannot move underwater. Most thrusters are brushless DC motor because no precision of thruster position is needed. The propeller is attached to the thrusters to “cut” thru the water and move forward.

The thrusters’ dynamics are still very much neglected and the oscillation usually ignored or tolerated. Thus, paper [15] and [16] derived the thrusters model for the under actuated condition from the motor’s electromechanical properties and the propeller’s hydrodynamics. The hydrodynamic propeller model can be derived from basic Newtonian fluid mechanic’s theory and is given by:

$$T = K_{T0}\Omega + K_T\Omega^2 \tag{1}$$

where:

T = Output thrust

Ω = The propeller rotational speed

K_{T0}, K_T = Lump parameter of various constants

The electromechanical model of a motor that relates the applied voltage, V , to the thrusters output T is given by [15]:

$$V = R_m I + L_m \dot{I} + K_E \Omega \tag{2}$$

$$T = K_m I \tag{3}$$

where:

I = the current flowing in the motor armature

R_m = motor resistance

L_m = motor inductance

K_E = motor back EMF constant

K_m = modified motor constant

The simulated result of transient response does not match with the observed oscillatory thrust values measured by the force sensor. In [15] the author’s

conclusion could possibly come from the experimental setup. In this experiment, the thrusters' transient can be tolerated and thus it was ignored. Only the steady state components of the thruster's model have been considered. Based on Equation (1) and Equation (2),

$$T = K_T \Omega^2 \quad (4)$$

$$V = R_m I + K_E \Omega \quad (5)$$

Substituting Equation (3) into Equation (4) and Equation (5).

$$I = \frac{T}{K_m}$$

$$T = K_T \Omega^2$$

$$\Omega = \left(\sqrt{\frac{T}{K_T}} \right)$$

$$V = R_m \frac{T}{K_m} + K_E \left(\sqrt{\frac{T}{K_T}} \right) \quad (6)$$

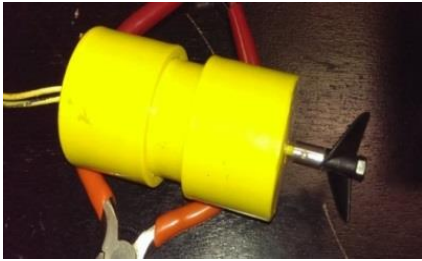

Figure 9 UTeRG Thrusters design

Figure 9 shows the actual thrusters in terms of body, propeller and coupling. Thrusters are generally propellers driven by electric DC motors. Due to the absence of propeller parameter, the system identification approach was used to model the thrusters. Two methods will be used one using the open library model for thrusters and another one using a system identification approach.

3.4 Microbox 2000/2000C

Micro-box 2000/2000C is a high performance, fan-less, low power consumption industrial PC as shown in Figure 10. The Micro-box has interfaces for analog to digital input and digital to analog output. This industrial PC can work with MATLAB and Simulink which makes it a top choice for intelligent controller to work with [17 -18]. The size of it is merely 255mm X 152mm X 82mm and weight of 2.0KG only. Micro-Box 2000/2000C is a solution for prototyping, testing and developing real-time system using standard Personal Computer (PC) hardware for running real-time

applications as shown in Figure 10. Micro-box 2000/2000C act as a microcontroller and also called as the XPC target machine. Micro-box 2000/2000C is a rugged, high-performance x86-based industrial PC with no moving parts inside [19]. It supports all standard PC peripherals such as video, mouse, and keyboard. For engineers who have real-time analysis and control systems testing needs, Micro-box 2000/2000C offers an excellent mix of performance, compact size, sturdiness, and I/O expandability [19]. User uses Micro-box 2000/2000C integrated with MATLAB/Simulink and related control modules. It can run real-time modelling and simulation of control systems, rapid prototyping, and hardware-in-the-loop testing. These tasks do not need any manual code generation and complicated debugging process. The result benefits the users in terms of costs, time saving and makes the control system design and testing easy to accomplish and flexible when dealing with complex control systems. In this research, Micro-box 2000/2000C is used to effectively interface between the actual ROV hardware and the control and analysis software used in a personal computer (PC).



Figure 10 Micro-box 2000/2000C

4.0 FUZZY LOGIC CONTROLLER

To implement the fuzzy logic controller to Micro-box 2000/2000C it is require to draw a block diagram in MATLAB Simulink. To design a closed-loop fuzzy logic controller, there will be need to perform experiment to obtain data from the pressure sensor's pressure input and voltage output accordingly. The data is then being process by MATLAB using system identification tools so that the transfer function can be obtain [20]. After obtain the transfer function, draw the block diagram as Figure 11 for fuzzy logic controller using Simulink and insert the transfer function into the plant.

A 5X5 input membership function is chosen and the rule based is obtained using principle as of journal [20]. Using the fuzzy toolbox in MATLAB, there will be a window which shows FIS editor as shown in Figure 12. Insert the input membership function and output membership function to the membership function editor of FIS editor as shown in Figure 13-Figure 15. Rules editor in FIS editor is used to insert the rule

based of the system as shown in Table 2. After saving the FIS file and export it to the Simulink fuzzy logic controller block diagram, run a simulation of it and obtain the result of it. Fine tune of the fuzzy logic controller by adjusting the output membership function have to be done if the result of the simulation is not suitable. The fine tune process have to be done according to journal [11] in order to ease the process of fine tuning as fine tuning a fuzzy logic control system is based on trial an error method and is very time consuming. Figure 16 shows the surface viewer of the rules fired in 3D in this system.

4.1 MATLAB Simulation

The block diagram was built by using MATLAB Simulink as shown in Figure 11 and the membership function was set as shown in Figure 13 to Figure 15. The transfer function was obtained from paper [20].

$$\frac{0.4147s^2 + 25.42s + 22.59}{s^3 + 3.78s^2 + 54.62s + 28.9} \tag{7}$$

$$A = \begin{bmatrix} -3.78 & -54.62 & -28.9 \\ 1 & 0 & 0 \\ 0 & 1 & 0 \end{bmatrix} \quad B = \begin{bmatrix} 1 \\ 0 \\ 0 \end{bmatrix} \tag{8}$$

$$C = [0.4149 \quad 25.42 \quad 22.59] \quad D = 0$$

The model in (7) are obtained from system identification technique will be analyse in terms of controllability and observability and also asymptotically stable. Based on state space matrices in (8), the system is both controllable and observable because the system has a rank of 3. This system is asymptotically stable when all eigenvalues of A have negative real parts. The rules were set up by rules editor as according to Table 2. Set the step input to 3 which indicates 3 meters. Run the simulation after export the fuzzy logic controller setting to the block diagram as shown in Figure 11.

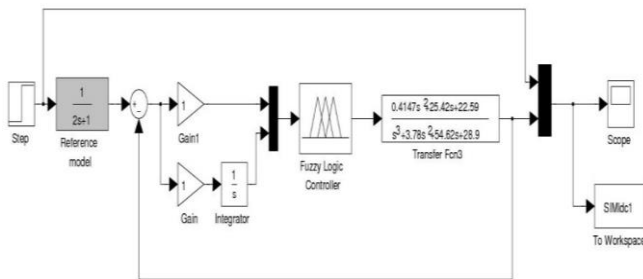

Figure 11 MATLAB simulink block diagram

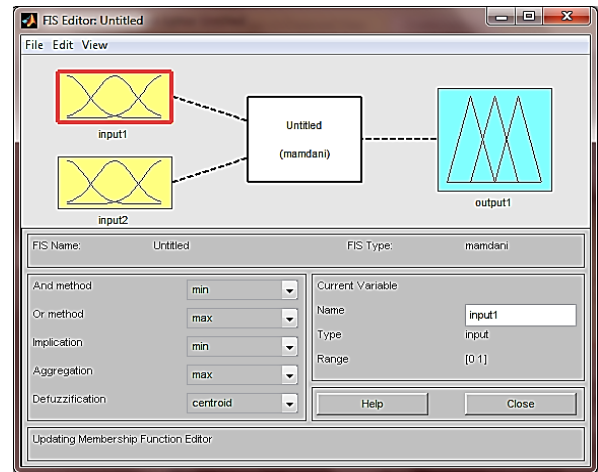

Figure 12 FIS Editor

Table 2 5x5 Matrix rules

Δe	NL	NS	Z	PS	PL
NL	NL	NL	NL	NS	Z
NS	NL	NS	NS	Z	PS
Z	NL	NS	Z	PS	PL
PS	NS	Z	PS	PS	PL
PL	Z	PS	PL	PL	PL

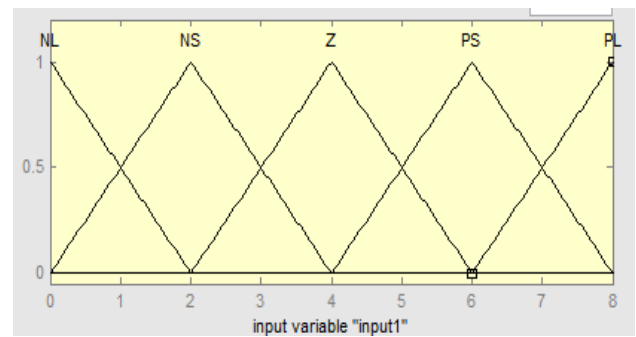

Figure 13 Input 1 membership function (e)

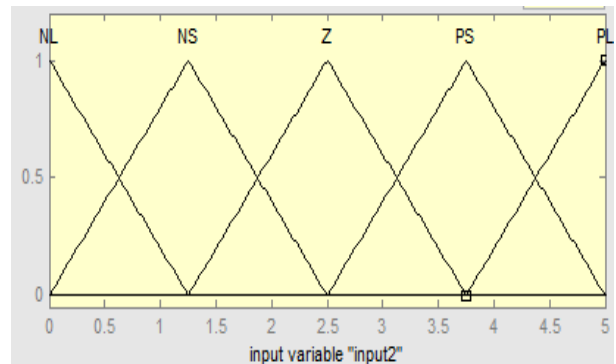

Figure 14 Input 2 membership function (Δe)

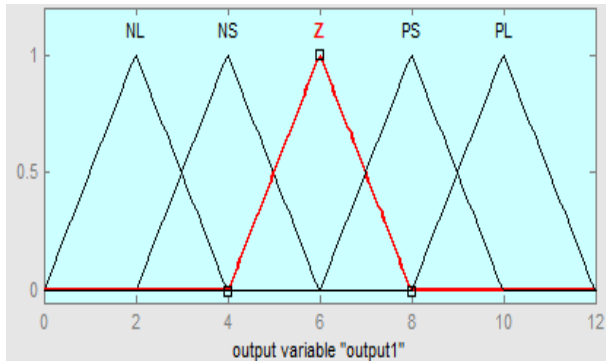

Figure 15 Output membership function

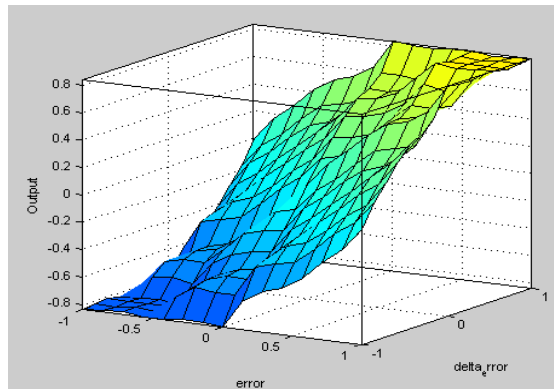

Figure 16 Surface view

5.0 RESULT AND DISCUSSION

Figure 17 shows the experimental set up in terms of hardware while Figure 18 shows the MATLAB Simulink block diagram for real time experimental. From Figure 13-15, all the altered zero membership function was compared with original “center” zero membership function. The value of altered zero membership function will be minus with value of “center” zero membership function. Negative result from the comparison either shows that the system has faster rise time and settling time, or lesser percent overshoot and steady state error. And it is vice versa for the positive result from the comparison. As an example, the “left” zero membership function adjustment show that the performance will decrease as the result of comparison is 0.2 second. But, the “right” zero membership function adjustment show that the performance will increase as the result of comparison is negative 0.2 second. Table 3 shows is that the simulation and real time results from adjusting the zero membership function increase, decrease, or maintain the performance of the output time respond.

The ideal voltage referring to Figure 19 is obtained from datasheet [21] and real voltage refers to the output voltage is obtained from experiment. To implement the data for real-time control block diagram in MATLAB Simulink, the linear equation of the pressure sensor’s characteristic have to be

determined. The pressure sensor do work almost as the same as expected from datasheet although the average error is 8.73%. This is because, the graph as shown in Figure 19 shows that the value of pressure sensor generally do not deviate much from the ideal voltage reading. Therefore, the pressure sensor is highly applicable to be use in the following experiment. Also, using the formula derived to determine the depth from sensor output voltage will also help in the following experiments as in Equation (9).

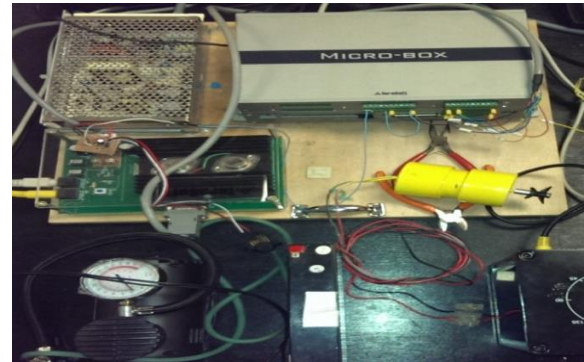

(a)

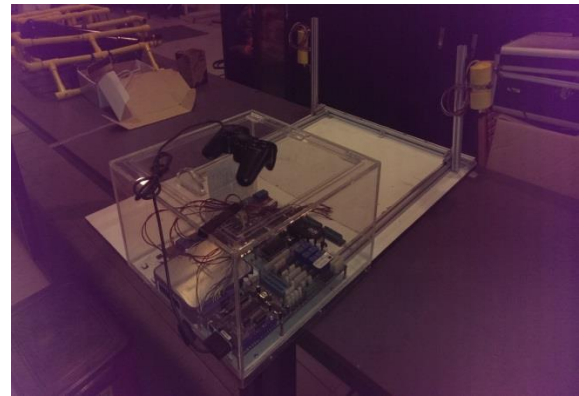

(b)

Figure 17 Experiment setup

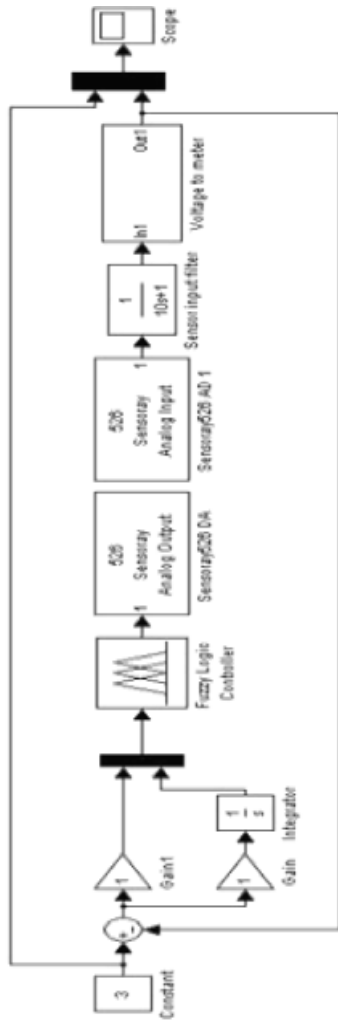

Figure 18 Block diagram for real-time control

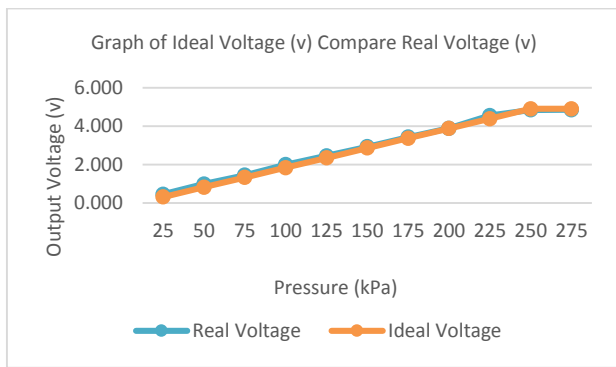

Figure 19 Graph of Ideal voltage compare to real voltage

Therefore, based on the graph on Figure 19, linear equation can be obtained as shown in Equation (9).

$$Y = 0.01987X - 0.0505 \tag{9}$$

$$X = \frac{Y + 0.0505}{0.01987} \tag{10}$$

	T_r	T_s	%OS	ϵ_{ss}
Center	Yellow	Yellow	Yellow	Yellow
Left	Red	Green	Red	Yellow
Right	Green	Green	Red	Red
Big	Green	Red	Red	Yellow
Small	Red	Green	Red	Yellow

(a)

	T_r	T_s	%OS	ϵ_{ss}
Center	Yellow	Yellow	Yellow	Yellow
Left	Red	Green	Red	Yellow
Right	Green	Green	Red	Red
Big	Green	Red	Red	Yellow
Small	Red	Green	Red	Yellow

(b)

Legend	
Green	Increasing performance
Red	decreasing performance
Yellow	same performance

Figure 20 Performance of shifting of zero membership function: (a) simulation; (b) real-time

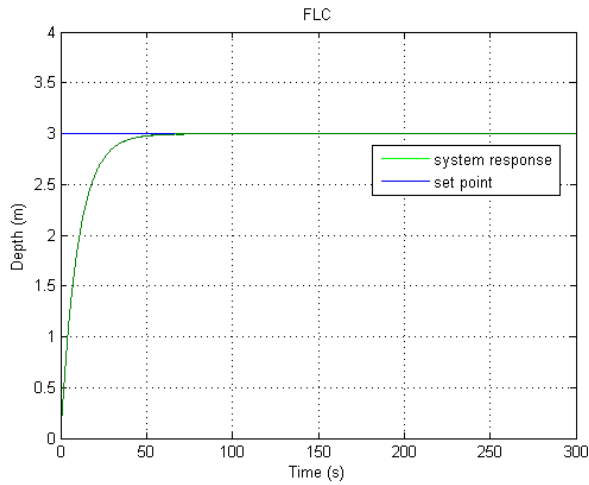

Figure 21 System response of FLC

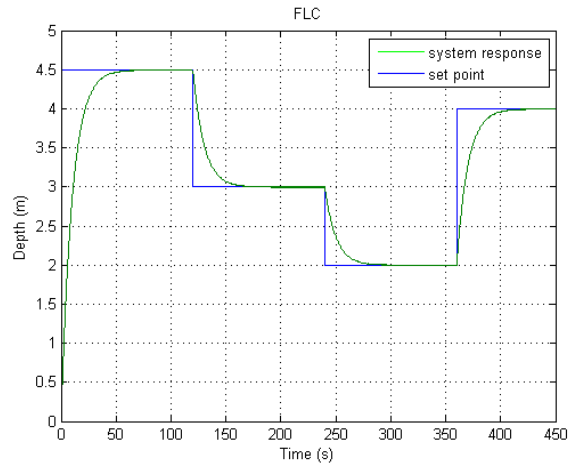

Figure 22 System response with difference set point

Table 3 Simulation and real-time result for effect of shifting of zero membership function

Simulation result for effect of shifting of zero membership function									
	Tr	diff.Tr	Ts	diff.Ts	%OS	diff.%OS	Settling max	Ess	diff.Ess
Center	10.26	NA	20.34	NA	0.20%	NA	3.01	0.01	NA
Left	10.28	0.02	19.56	-0.79	0.24%	0.03%	3.01	0.01	0.00
Right	10.24	-0.02	18.23	-2.11	3.81%	3.61%	3.11	0.11	0.11
Big	10.25	-0.01	21.53	1.18	0.27%	0.07%	3.01	0.01	0.00
Small	10.27	0.01	19.74	-0.60	0.22%	0.01%	3.01	0.01	0.00
Real-time result for effect of shifting of zero membership function									
	Ave Tr	diff.Tr	Ave Ts	diff.Ts	Ave %OS	diff.%OS	Ave Ess	diff.Ess	
Center	10.30	NA	20.35	NA	0.21%	NA	0.01	NA	
Left	10.33	0.03	19.55	-0.79	0.24%	0.03%	0.01	0.00	
Right	10.24	-0.06	18.23	-2.11	3.86%	3.66%	0.12	0.12	
Big	10.29	-0.01	21.53	1.18	0.30%	0.09%	0.01	0.00	
Small	10.32	0.02	19.74	-0.60	0.20%	0.00%	0.01	0.00	

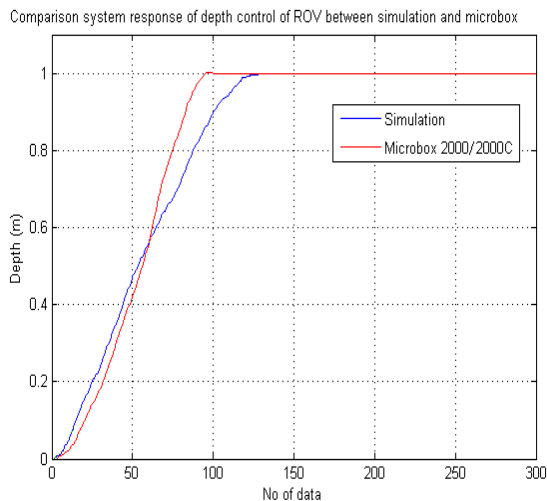

Figure 23 Comparison system response of depth control between simulation and microbox 2000/2000C

Figure 20 shows the performances of shifting the zero membership function including the legend for color indicator. Figure 21 shows the system response using MATLAB software for the ROV for depth 3 meter while Figure 22 shows the system response with different set point. Based on both Figure on results for system response no overshoot, faster rise time and very small steady state error. Table 3 tabulated data for simulation and real time result for effect of shifting of 'zero' membership function. Figure 23 shows the comparison system response of depth control of ROV between simulation and microbox 2000/2000C. The results using microbox 2000/2000C faster rise time compared with simulation results.

6.0 CONCLUSION

It can be conclude that is possible to implement Fuzzy Logic Controller for ROV depth control using Micro-box 2000/2000C although the Fuzzy Logic Controller is extremely time costing to tune. The

pressure sensor meets the standard and the sensor is eligible to be use throughout the experiment. The output membership function of the fuzzy logic controller will be tuned until the result meets the requirement to keep the ROV at a depth of 3 meter. The result shows that by changing positive large and negative large membership function to trapezoid and set the output voltage range from 0 to 9, the simulation of the ROV can stay at a depth of 3 meters with acceptable time respond. Adjusting the zero membership output function, the time respond will change in term of rise time, settling time, percent overshoot, and steady state error. The result can use as a common technique to fine tune the fuzzy logic controller. The different result for simulation and real time control using Micro-box 2000/2000C did not differ too much between each other. This means that the simulation is highly similar to that of the real-time Micro-box 2000/2000C interfacing.

Acknowledgement

We wish to express our gratitude to honorable University, Universiti Teknikal Malaysia Melaka (UTeM) and Universiti Teknologi Malaysia (UTM) especially for Underwater Technology Research Group (UTeRG), Centre of Research and Innovation Management (CRIM) and to Faculty of Electrical Engineering from UTeM to give the financial as well as moral support for complete this project successfully.

References

- [1] Zanolli S. M. and Conte. G. 2003. Remotely Operated Vehicle Depth Control. *Control Engineering Practice*. 11(4): 453-459.
- [2] Azis, F. A. Aras, M. S. M. Abdullah, S. S. Rashid, M. Z. A. and Othman. M. N. 2012. Problem Identification for Underwater Remotely Operated Vehicle (ROV): A Case Study. *Procedia Engineering*. 41: 554-560.
- [3] Side Zhao and J. Yuh. 2005. Experimental Study on Advanced Underwater Robot Control. *IEEE Trans. Robot.* 21(4): 695-703.
- [4] M. S. M. Aras, F. A. Azis, M. N. Othman and S. S. Abdullah. 2012. A Low Cost 4 DOF Remotely Operated Underwater Vehicle Integrated With IMU and Pressure Sensor. *4th International Conference on Underwater System Technology: Theory and Applications 2012 (USYS'12), Malaysia*. 18-23.
- [5] B. P. Investigations and Legal Proceedings. www.bp.com. [Online]. Available: www.bp.com/en/global/corporate/gulf-of-mexico-restoration/investigations-and-legal-proceedings.html [Accessed: May 1, 2014].
- [6] Aras, M. S. M, S. S. Abdullah, Rashid, M. Z. A, Rahman, A. Ab, Aziz, M. A. A. 2013. Tuning Process of Single Input Fuzzy Logic Controller Based on Linear Control Surface Approximation Method for Depth Control of Underwater Remotely Operated Vehicle. *Journal of Engineering and Applied Sciences*. 8(6): 208-214.
- [7] Mohd Aras, Mohd Shahrieel, Abdullah, Shahrum Shah, Abdul Rahman, Ahmad Fadli Nizam and Abdul Aziz, Muhammad Azhar. 2013. Analysis of an Improved Single Input Fuzzy Logic Controller Designed For Depth Control Using Microbox 2000/2000c Interfacing. *International Review of Automatic Control*. 6(6): 728-733.
- [8] I. S. Akkizidis, G. N. Roberts, P. Ridao, and J. Battle. 2007. Designing a Fuzzy-like PD Controller for an Underwater Robot. *Control Engineering Practice*. 11(4): 471-480.
- [9] C. Silvestre and A. Pascoal. 2007. Depth Control of the INFANTE AUV Using Gain-scheduled Reduced Order Output Feedback. *Control Engineering Practice*. 15(7): 883-895.
- [10] C. C. Lee. 1990. Fuzzy Logic in Control System: Fuzzy Logic Controller Part I. *IEEE Trans. Syst. Man Cybernetics*. 20(2): 404-418.
- [11] M. S. M. Aras, F. B. A. Azis, S. Hamid, F. A. B. Ali and S. S. B. Abdullah. 2011. Study of the Effect in the Output Membership Function When Tuning a Fuzzy Logic Controller. *IEEE International Conference on Control System, Computing and Engineering (ICCSCE)*. 1-6.
- [12] Mohd Shahrieel Mohd Aras, Fadilah Abdul Azis. 2014. ROV Trainer for Education. *International Journal of Science and Research Engineering*. 3(5): 1-7.
- [13] M. S. M. Aras, S. S. Abdullah, S. S. Shafei, M. Z. A. Rashid, A. Jamali. 2012. Investigation and Evaluation of Low cost Depth Sensor System Using Pressure Sensor for Unmanned Underwater Vehicle. *Majlesi Journal of Electrical Engineering*. 6(2).
- [14] David Heeley. Sensor Product Division, Pheonix, Arizona. *Understanding Pressure and Pressure Measurement*. www.freescale.com/files/sensors/doc/app_note/AN1573.pdf. 2014. [Accessed: May 1, 2014].
- [15] T. H. Koh, M. W. S. Lau, E. Low, G. Seet, S. Swee and P. L. Cheng. 2002. *Development and Improvement of an Underactuated Underwater Robotic Vehicle*. Nanyang Technological University, Singapore. 2039-2044.
- [16] T. H. Koh, M. W. S. Lau, E. Low, G. Seet, S. Swee and P. L. Cheng. 2002. A Study of the Control of an Underactuated Underwater Robotic Vehicle. *Proceedings of the 2002 IEEE/RSJ*. 2049-2054.
- [17] M. S. M. Aras, S. S. Abdullah, A. A. Rahman, M. A. A. Aziz. 2013. Thruster Modelling for Underwater Vehicle Using System Identification Method. *International Journal of Advanced Robotic Systems*. 10: 1-12.
- [18] Aras, M. S. M, S. S. Abdullah, Rashid, M. Z. A, Rahman, A. Ab and Aziz, M. A. A. 2013. Robust Control of Adaptive Single Input Fuzzy Logic Controller for Unmanned Underwater Vehicle. *Journal of Theoretical and Applied Information Technology*. 57.
- [19] Data sheet Micro-box MathWorks™ xPC Enabled real-time system. Solutions 4U Sdn. Bhd. http://www.solutions4u-asia.com/PDT/TS/MBox/MBox_files/S4U%20Microbox%20Brochure.pdf. 2012. [Accessed: May 1, 2014].
- [20] Aras, M. S. M, S. S. Abdullah, Rashid, M. Z. A, Rahman, A. Ab, Aziz, M. A. A. 2013. Development and Modeling of underwater Remotely Operated Vehicle using System Identification for depth control. *Journal of Theoretical and Applied Information Technology*. 56.
- [21] Motorola. Manifold Absolute Pressure (MAP) Sensor. MPX4250 datasheet, 1997. [Accessed: May 1, 2014].