

An Experimental Study on Surface Discharge Characteristics of Different Types of Polymeric Material under AC Voltage

N. Baharin^a, Y. Z. Arief^{a*}, W. A. Izzati^a, M. Z. H. Makmud^b, Z. Adzis^a, M. A. B. Sidik^b

^aInstitute of High Voltage and High Current, Faculty of Electrical Engineering, Universiti Teknologi Malaysia, 81310 UTM Johor Bahru, Johor, Malaysia

^bSchool of Science and Technology, Universiti Malaysia Sabah, Kota Kinabalu, Sabah, Malaysia

*Corresponding author: yzarief@fke.utm.my

Article history

Received :15 February 2013

Received in revised form :
10 June 2013

Accepted :16 July 2013

Graphical abstract

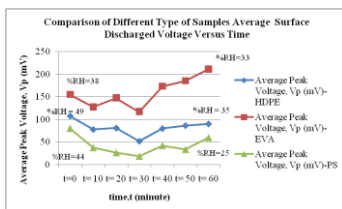

Average peak voltage of surface discharge for HDPE, EVA and PS during ageing time

Abstract

Surface discharge is a common electrical discharge that normally occurs on the surface of outdoor insulators and also causes the failure in the electrical insulation system. One of the causes of surface discharge is the presence of high voltage stress. Experimental works had been carried out to examine the surface discharge characteristics on polymeric samples as insulation material. The IEC (b) electrode configuration had been used to investigate the surface discharges phenomena of different types of polymeric materials with controlled of air relative humidity (RH). In these experimental works, three types of polymeric sample were selected, namely high-density polyethylene (HDPE), ethylene-vinyl acetate (EVA), and polystyrene (PS), respectively. The characteristics of the discharge are critically depending on the types of polymer. Surface discharges intensity, number of discharge occurrence, and surface morphology of each polymeric material were also investigated. Comparisons of these electrical characteristics were conducted among the samples. Results from the experiment showed that the EVA samples experienced severe degradation as compared to HDPE and PS samples.

Keywords: Surface discharge; high-density polyethylene; ethylene-vinyl acetate; polystyrene; surface morphology

Abstrak

Nyahcas permukaan adalah nyahcas elektrik biasa yang selalunya berlaku pada permukaan penebat luar dan juga menyebabkan kegagalan dalam sistem penebat elektrik. Salah satu punca nyahcas permukaan adalah kehadiran tekanan voltan tinggi. Kerja-kerja eksperimen telah dijalankan untuk mengkaji ciri-ciri nyahcas permukaan polimer sebagai bahan penebat. Konfigurasi elektrod IEC (b) telah digunakan untuk menyiasat fenomena nyahcas permukaan jenis bahan polimer dengan kawalan kelembapan relatif. Dalam eksperimen ini, tiga jenis polimer telah dipilih iaitu polietilena berketumpatan tinggi (HDPE), etilena vinil asetat (EVA), dan polistirena (PS). Ciri-ciri nyahcas ini bergantung secara kritis kepada jenis polimer. Intensiti nyahcas permukaan, bilangan kejadian nyahcas, dan morfologi permukaan setiap bahan polimer telah dikaji. Perbandingan ciri-ciri elektrik yang telah dijalankan di kalangan sampel disiasat. Hasil eksperimen menunjukkan bahawa sampel EVA mengalami kemusnahan yang teruk berbanding sampel HDPE dan PS.

Kata kunci: Nyahcas permukaan; polietilena berketumpatan tinggi; etilena vinil asetat; polistirena; morfologi permukaan

© 2013 Penerbit UTM Press. All rights reserved.

1.0 INTRODUCTION

Surface discharges can occur in a gas, liquid, or a vacuum in close to a solid dielectric surface. Even though the magnitude of such discharges is usually small, they can cause progressive deterioration and lead to failure. Therefore, it is important to investigate these surface discharge characteristics to find the solutions for the problem occurring in solid dielectrics. Solid dielectric materials are used in all kinds of electrical apparatus and devices to insulate one current carrying part from another

when they operate at different voltages. A good dielectric should have low dielectric loss, high mechanical strength, free from gaseous inclusions and moisture, and resistant to thermal and chemical deterioration. Solid dielectrics have higher breakdown strength compared to liquids and gases. There are two types of solid insulating materials that are generally used in practice; namely the organic materials, such as paper, wood, rubber, and the inorganic materials, such as mica, porcelain, and synthetic polymers (either perspex, high-density polyethylene (HDPE),

polypropylene (PP), polyvinyl chloride (PVC), ethylene-vinyl acetate (EVA) or polystyrene (PS)).

Partial discharge is an electrical discharge that bridges a small portion of insulation between two conducting electrodes when voltage is applied to the surface of an insulator. It can be divided into three types, which are internal discharge, surface discharge and corona discharge¹. They are the important factor of ageing in the insulation surface which leads to failure of insulation system.

Surface discharge is one of the electrical discharges and it has always become an initial stage of ageing process of the insulator materials. It can be stated that the definition of the surface discharge is discharge occurring at the surface of the dielectric. It occurs when the surface conductivity is increased due to a combined action of humidity and the dissociation product of air.

The effect of surface discharge activities can be observed according to the electrical characteristic such as discharge intensity and the physical surface morphology of the material's surface. Surface exposed to the discharge may cause deterioration to the surface of the materials and then lead to failure of the insulating materials.

2.0 MATERIALS AND METHODS

2.1 Sample

In this experimental study, three types of polymeric materials used were high-density polyethylene (HDPE), polystyrene (PS) and ethylene-vinyl acetate (EVA). Each material has its own characteristics. EVA is copolymer of ethylene and vinyl acetate. It is an extremely elastic material that can be sintered to form a porous material similar to rubber, yet with excellent toughness. It is three times as flexible as LDPE. PS is a vinyl polymer. Structurally, it is a long hydrocarbon chain, with a phenyl group attached to every other carbon atom. HDPE is the high density version of polyethylene (PE) plastic. It is harder, stronger and a little heavier than LDPE, but less ductile.

The slab samples having a dimension of 3"×3" are as shown in Figure 1.

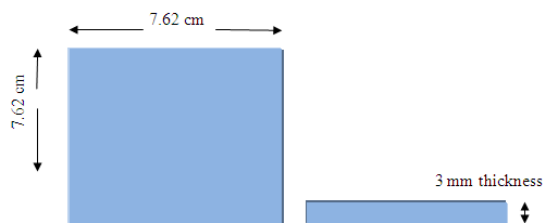

Figure 1 The dimension of polymeric sample

2.2 IEC (b) Electrode Configuration Chamber

IEC (b) electrode configuration (IEC 60343:1991) is a recommended standard test method for determining the relative resistance of insulating materials to breakdown by surface discharges. According to this method, we can also observe the discharge intensity as an electrical parameter for this experiment.

In this experiment, the IEC (b) electrode chamber was placed in closed condition to control the relative humidity of the air inside the chamber during the experiment. Figure 2 shows the IEC (b) electrode configuration setup used in this study.

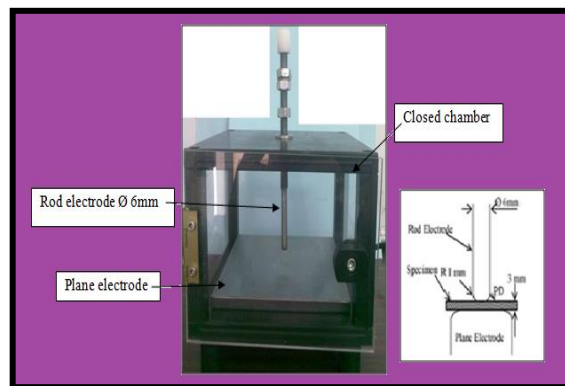

Figure 2 Complete closed chamber electrode configuration setup for surface discharge test

2.3 Experimental Procedure

Figure 3 shows circuit diagram for the experimental setup. The experiment was done using HVAC supply to test the polymeric material samples. The relative humidity in the closed electrode chamber was fixed at medium range of 25-49% and controlled by silica gels. The percentage reading of relative humidity was taken using hygrometer. 8kVrms AC voltage was applied on the sample at frequency of 50Hz with constant ageing time for 1 hour.

Three samples were tested in this experimental study. They are from polymeric materials group which are high-density polyethylene (HDPE), ethylene-vinyl acetate (EVA), and polystyrene (PS).

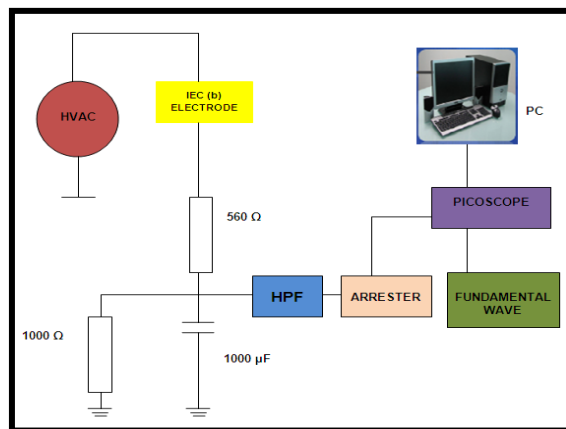

Figure 3 Experimental setup for surface discharge test

3.0 RESULTS AND DISCUSSION

3.1 Surface Morphology

The degraded area on the samples surfaces that were affected from the high voltage application were observed by using stereo microscope (SZM Series) in IVAT laboratory. By using the microscope, the surface morphology of each sample was analyzed based on qualitative method. The physical surface of HDPE insulator is observed before and after experiment using digital microscope at 0.7, 1.0 and 2.0 magnifying images at 1280x1024 pixels resolution.

Figure 4, Figure 5, and Figure 6 show the picture of each sample for unaged and aged images of the degraded area on the samples.

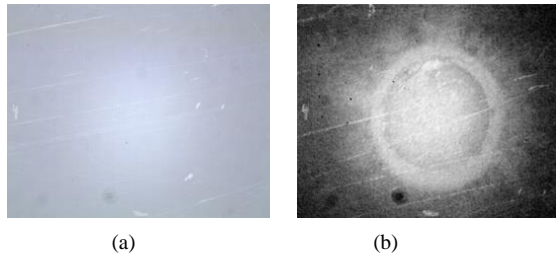

Figure 4 Picture of HDPE sample; (a) before and (b) after 1h of ageing time

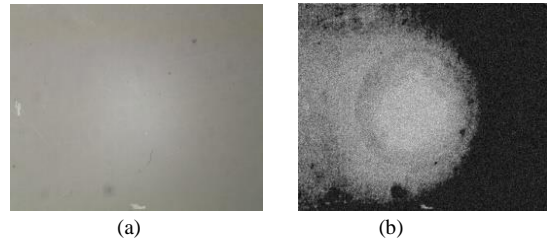

Figure 5 Picture of EVA sample; (a) before and (b) after 1h of ageing time

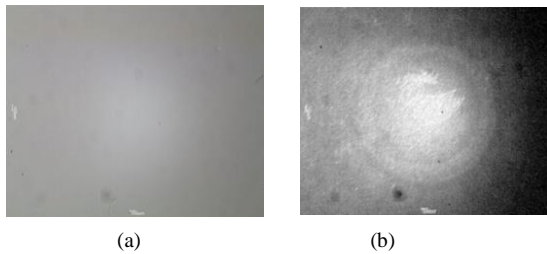

Figure 6 Picture of PS sample; (a) before and (b) after 1h of ageing time

Figure 7 shows comparison between three different types of samples. The picture captured after experiment for 0.7 magnifying mode was modified using special technique in order to get better image. As seen from the figure, EVA surface is not clearly degraded because EVA is a transparent material. So, it is difficult to see the surface degradation effect using SZM Series. However, if the observation was without the SZM, the surface degradation effect can be seen by using filter application.

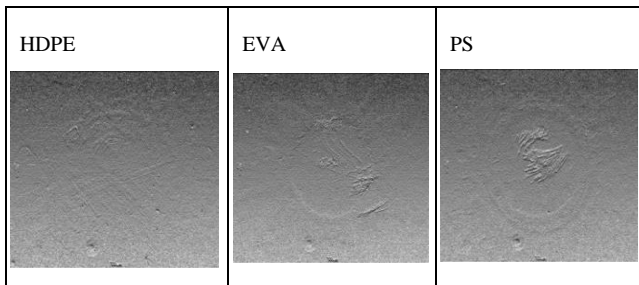

Figure 7 Comparison for the aged samples for HDPE, EVA and PS after 1h of ageing time

3.2 Surface Discharge Characteristics

The magnitude of the partial discharge intensity was captured using *Picoscope* (Series 3000) and its software that was installed in the computer. Partial discharge intensity was captured for every 10 minutes during 1 hour ageing time. The data was tabulated to make work easier and all captured waveforms were stored in proper folder in computer.

Figure 8 shows the average peak voltage of surface discharge for each sample during 1h ageing time. As can be clearly seen from the figure, EVA sample has the highest average surface discharge voltage compared to that for HDPE and PS. It is also observed that there is a trend of discharge voltages that rise and fall within minute 0 to minute 50.

Figure 9 shows the average occurrence of surface discharge of each sample during 1h ageing time. The average number of the surface partial discharge occurrence per second is calculated using formula (1).

$$Avg\ Frequency = \frac{\sum No\ of\ Partial\ Discharge\ Occurrence}{\sum No\ of\ Frame\ in\ One\ Caption} \quad (1)$$

Where 32 frames = 1 second

The graph shows that the HDPE have the highest number of partial discharge vary with time. Meanwhile, PS has the lowest number of partial discharge.

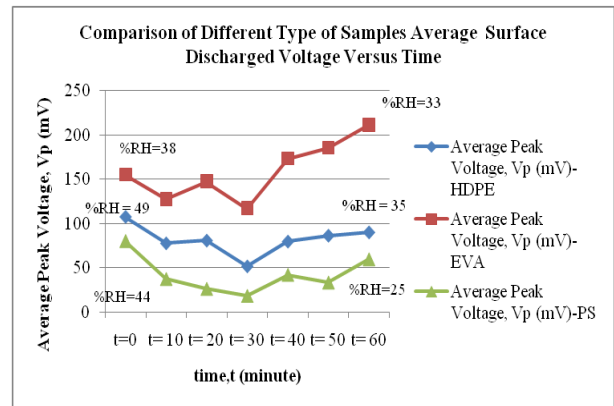

Figure 8 Average peak voltage of surface discharge for HDPE, EVA and PS during ageing time

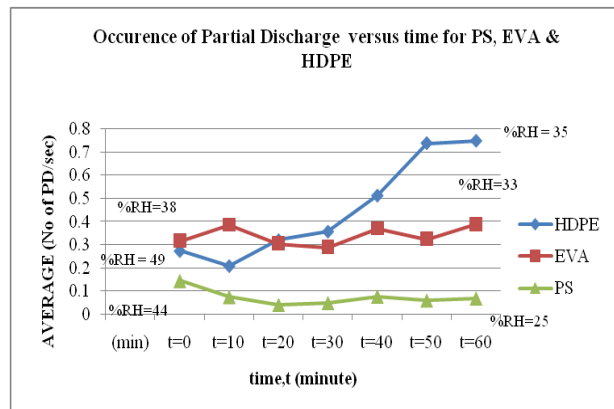

Figure 9 Average occurrence of surface discharge for HDPE, EVA and PS during ageing time

Generally, the surface discharge characteristic observed from this experimental study depended on the types of polymeric materials and the relative humidity.

Each polymer has its own characteristics and properties. The arrangement of the electron and molecule bonding greatly influences chemical and physical properties of the polymer. The stronger the chemical bonding, the harder the surface degradation to occurs. So, when a high voltage stress is applied on the surface of the polymer, it will affect the arrangement of its electrons and thus, some chemical reaction occur.

It is observed that there is a trend of discharge voltages which rise and fall during 1 hour experiment. This is due to the discharge voltages that have become a source of energy that used in breaking the covalent bond within the polymeric molecular structure causing electrochemical degradation of polymeric structure. Later, energy is released in the form of heat and this heat will roughen the surface and cause erosion to form surface cavities.

Degradation occurs when the electrons in a polymeric bond are very strongly attracted to another atom or molecule (called a “foreign” atom or molecule) outside the bond that the polymer bond breaks. The foreign molecules are often part of the environment surrounding the polymeric material. In this experimental study, it is affected through source of high voltage. The most common foreign molecule that has significant effects on polymer is oxygen. The process of reaction with oxygen is called oxidation⁵.

The surface discharges of HDPE, EVA and PS might cause chemical reaction which alters the inner molecular bonding of organic polymeric sample. Energy from partial discharges is used to break the covalent bond to form free radical to react with moisture in the air when operations are prolonged. Heat dissipated in form of spark erodes the surface of the HDPE and causes rough surface with many small cavities. This is observed on the surface of the sample under microscopic view.

As time passes, these cavities eventually lead to treeing and possible of insulation failure. High humidity and contamination such as dirt will speed up the process of breakdown. Dirt contamination and moisture film foamed on the insulation surface due to high humidity in an open-air arrangement cause increased electrical conductivity which might increase the frequency of the partial discharges. Hence, dry and clean surface may help to minimize or eliminate the ageing time effect of partial discharge on polymeric insulator.

■4.0 CONCLUSION

In summary, surface discharges of polymeric material under high voltage AC cause severe polymeric sample’s surface deterioration as time passes. The prolonged operation under high voltage stress causes tracking and treeing; being two of the ageing time effects which gradually lead to permanent insulation failure or breakdown.

By using closed condition IEC (b) electrode configuration (IEC 60343:1991), surface discharges characteristics of polymeric materials could be observed and studied under AC voltage to explore surface discharge and its effect on polymeric materials as an insulating material.

The results revealed that EVA samples have the most severe degradation on its surface compared to that on HDPE and PS.

Acknowledgement

The authors would like to thank Malaysia Ministry of Higher Education, *Universiti Teknologi Malaysia* (UTM) for the use of facilities to complete this research project under research university grant (RUG) with vote number Q.J130000.2523.00H19.

References

- [1] Dr F. H. Kreuger. 1964. *Discharge Detection in HV Equipment*. Butterworth & Co.
- [2] Chai Pei Keon, Nur Akmal Bt Mohd Zin, Mohd Faiz Bin Mohd Jailani, Muhd Hazrul B. Mustapha. 2009. *Effect of Ageing Time on Surface Discharge Characteristics of Polymeric Materials under AC Voltage*. UTM Skudai.
- [3] Mohamad Zul Hilmey Bin Makmud. 2009. *An Experimental Study Surface Discharge Characteristic on the Polymeric Materials under AC Voltage*. Universiti Teknologi Malaysia, PSM Thesis.
- [4] British Standard (BS EN 60343:1993/IEC 343:1991). *Recommended Test Methods for Determining the Relative Resistance of Insulating Materials to Breakdown by Surface Discharges*.
- [5] Yanuar Z. Arief. *Study On Partial Discharge Degradation Mechanism of Polymeric Power Cable Insulating Material*. Ph.D. Thesis.
- [6] P. B. Moore, J. Louisnathan. 1967. *Science*. 156: 1361.
- [7] M. A. Elborki, P. A. Crossley, Z. D. Wang, A. Darwin, G. Edwards. 2002. *Detection and Characterisation of Partial Discharges in Transformer Defect Models*.
- [8] C. Chang and Q. Su. 2000. *Partial Discharge Distribution Pattern Analysis Using Combined Statistical Parameters*. Department of Electrical & Computer Systems Engineerin. Monash University, Australia.
- [9] M. S. Naidu, V. Kamaraju. 2004. *High Voltage Engineering*. Third Edition McGraw Hill. Singapore.