

**DESIGN AND PROCESS FOR PRODUCING SILANE-
CROSSLINKED POLYOLEFIN COMPOUND**

**PM DR SHAHRIR HASHIM
PM DR WAN AIZAN WAN ABDUL RAHMAN
TOH SHOW CHONG**

**NO. VOT PENYELIDIKAN
71815**

**JABATAN KEJ. POLIMER
FAK. KEJ. KIMIA DAN KEJ. SUMBER ASLI
UTM SKUDAI, JOHOR**

BORANG PENGESAHAN
LAPORAN AKHIR PENYELIDIKAN

TAJUK PROJEK : DESIGN AND PROCESS FOR PRODUCING SILANE-CROSSLINKED
POLYOLEFIN COMPOUND

Saya DR SHAHRIR BIN HASHIM

(HURUF BESAR)

Mengaku membenarkan Laporan Akhir Penyelidikan ini disimpan di Perpustakaan Universiti Teknologi Malaysia dengan syarat-syarat kegunaan seperti berikut :

1. Laporan Akhir Penyelidikan ini adalah hakmilik Universiti Teknologi Malaysia.
2. Perpustakaan Universiti Teknologi Malaysia dibenarkan membuat salinan untuk tujuan rujukan sahaja.
3. Perpustakaan dibenarkan membuat penjualan salinan Laporan Akhir Penyelidikan ini bagi kategori TIDAK TERHAD.
4. * Sila tandakan (✓)

SULIT (Mengandungi maklumat yang berdarjah keselamatan atau Kepentingan Malaysia seperti yang termaktub di dalam AKTA RAHSIA RASMI 1972).

TERHAD (Mengandungi maklumat TERHAD yang telah ditentukan oleh Organisasi/badan di mana penyelidikan dijalankan).

TIDAK TERHAD

TANDATANGAN KETUA PENYELIDIK
DR SHAHRIR BIN HASHIM

Nama & Cop Ketua Penyelidik
Tarikh : 29/11/2006

CATATAN : * Jika Laporan Akhir Penyelidikan ini **SULIT** atau **TERHAD**, sila lampirkan surat daripada pihak berkuasa/organisasi

PENGHARGAAN

Pertama sekali saya ingin mengucapkan setinggi-tinggi terima kasih kepada pihak UPP Universiti Teknologi Malaysia kerana memberikan peruntukkan kewangan melalui Vot 71820 membolehkan saya menjalankan projek penyelidikan ini dengan jayanya.

Perhargaan yang ikhlas ditujukan kepada PM Dr Wan Aizan Wan Abdul Rahman sebagai ahli penyelidik serta penyelia bersama untuk pelajar master, Toh Show Chong. Penghargaan juga ditujukan kepada rakan-rakan yang telah menjayakan projek ini secara langsung ataupun tidak langsung.

ABSTRACT

A formulation was designed to produce silane crosslinkable HDPE compound suitable for extrusion blow molding by melt blending technique on Magic[®] extrusion blow molding machine. The formulations consist of HDPE as the base polymer, a carrier chemical pack containing an organic unsaturated silane and a free radical generating agent and condensation catalyst. In designing and formulating silane crosslinkable blow molded HDPE compounds with satisfactory properties, ASTM D 2647 was used as the reference. Grafting and crosslinking reaction was proposed for the formulated system. The product was characterized for the chemical, thermal, physical and mechanical properties. The chemical reactions during grafting and crosslinking involved a three step mechanisms. Extrusion blow molded bottle were stored in water for curing at various temperature and time. DSC, FTIR and TGA were used to determine the chemical groups involved in the reactions and gel contents were determined in parallel. The results from curing showed that a further formation of Si-O-Si crosslink's took place after the point at which maximum gel contents has been reached. Mechanical measurements indicated that further crosslink's were formed within the existing gel. Suitable range concentration relating to 100 parts of base polymer was found for vinyltrimethoxysilane (VTMO) to be between 1.6 to 2.0 phr. The concentration of dicumyl peroxide (DCP) initiator was between 0.1 to 0.5 phr. The concentration of dibutyltin dilaurate (DBTL condensation catalyst) was being 0.005 to 0.02. When the DBTL amount was less than 0.005 phr, the crosslinking reaction did not proceed sufficiently. When the DBTL amount was larger than 0.02 phr, local crosslinking proceeds in the extruder at the time of extrusion, resulting in a greatly deteriorated appearance of the product. The selected components used in the formulation are HDPE grade HB6200, vinyltrimethoxysilane (VTMO) as the crosslinking agent, dicumyl peroxide (DCP) as the initiator, dibutyltin dilaurate (DBTL) as the condensation catalyst and Irganox 1010 as the antioxidant. The blow molded bottle properties and processability of the compound depends on the formulation and process parameter.

ABSTRAK

Formulasi telah direkabentuk untuk menghasilkan sebatian HDPE berangkai silang yang sesuai untuk penyemperitan tiupan dengan teknik penyemperitan reaktif pada mesin Magic[®]. Formulasi ini mengandungi HDPE sebagai polimer asas, pembawa kimia yang mengandungi silane tidak tepu, agen penjanaan radikal bebas dan pemangkin kondensasi. Dalam rekaan formulasi sebatian HDPE berangkai silang, ASTM D2647 dirujuk. Tindak balas pencantuman dan perangkaian silang digunakan dalam sistem formulasi. Produk diciri berdasarkan sifat kimia, terma, fizik dan mekanik. Tindak balas kimia semasa pencantuman dan perangkaian silang melibatkan tiga langkah mekanisma. Botol penyemperitan adunan disimpan dalam air untuk pengawetan pada pelbagai suhu dan masa. DSC, FTIR, TGA digunakan untuk penentuan kumpulan kimia yang terlibat dalam tindak balas kimia dan kandungan gel. Keputusan daripada pengawetan menunjukkan bahawa formulasi ikatan Si-O-Si berlaku selepas takat kandungan maksima gel tercapai. Ukuran mekanik menunjukkan bahawa perangkaian silang seterusnya terbentuk dalam keadaan gel yang tersedia ada. Julat kepekatan yang bersesuaian berdasarkan 100 bahagian polimer asas untuk vinyltrimethoxysilane (VTMO) ialah 1.6 hingga 2.0 phr. Kepekatan pemula dicumyl peroxide (DCP) ialah 0.1 hingga 0.5phr. Kepekatan pemangkin kondensasi dibutyltin dilaurate (DBTL) ialah 0.005 hingga 0.02. Apabila kepekatan DBTL kurang daripada 0.005 phr, tindak balas berangkai silang tidak berlaku dengan berkesan. Apabila kepekatan DBTL lebih daripada 0.002 phr, perangkaian silang setempat berlaku dalam penyemperit pada masa penyemperitan, menyebabkan kemerosotan permukaan produk. Komponen terpilih dalam formulasi ini ialah HDPE gred HB6200, vinyltrimethoxysilane (VTMO) sebagai agen perangkaian silang, dicumyl peroxide (DCP) sebagai pemula, dibutyltin dilaurate (DBTL) sebagai pemangkin kondensasi dan Irganox 1010 sebagai anti bahan pengoksidaan. Sifat dan kebolehprosesan botol penyemperitan adalah bergantung pada formulasi dan parameter proses.

TABLE OF CONTENTS

CHAPTER	TITLE	PAGE
	Title Page	i
	Declaration	ii
	Dedication	iii
	Acknowledgements	iv
	Abstract	v
	Abstrak	vi
	Table of contents	vii
	List of tables	xii
	List of figures	xiv
	List of abbreviations and symbols	xxi
I	INTRODUCTION	1
	1.1 Introduction	1
	1.2 Problems Statement	4
	1.3 Objective	5
	1.4 Scopes	5

2	LITERATURE REVIEW	6
2.1	Scope	6
2.2	History of Polyethylene	6
2.3	Manufacture of Polyethylene	7
2.4	The Chemistry of Polyethylene	8
2.5	Polymer Characteristics	11
2.5.1	Order And Disorder In Polyethylene	11
2.5.2	Basic Molecular Properties Affect Resin and End Product Properties	12
2.5.3	Effect of Changes in Average Molecular Weight.	15
2.5.4	Effect of Molecular Weight Distribution on Properties.	16
2.5.5	Effect of Density and Molecular Weight on Polyethylene Properties	18
2.5.6	Compromise Between Stress Cracking Resistance and Rigidity	20
2.5.7	Environmental Stress Crack Resistance Properties	21
2.6	Overview of Crosslinked Polyethylene Technologies	25
2.6.1	Introduction	25
2.6.2	Crosslinked Polyethylene	26
2.6.3	Crosslinking Improve Polyethylene Properties	26
2.7	Methods of Crosslinking Polyethylene	27
2.7.1	Physical Crosslinking (Radiation Method)	29
2.7.2	Chemical Crosslinking	30
2.7.2.1	Azo Method	30
2.7.2.2	Peroxide Method	31
2.7.2.3	Silane Method	33
2.7.2.3.1	Sioplast Method	34
2.7.2.3.2	Monosil Method	35

2.7.2.3.3	General Variation of The Monosil Process and the Sioplas Process	36
2.7.2.3.4	Siloxan Method	37
2.7.2.3.5	Silane Grafting Reaction Mechanism	39
2.8	Crosslinking Method Selection	41
2.9	Chemical Additives Used In Formulation	42
2.9.1	Crosslinker –Vinyltrimethoxysilane	42
2.9.2	Peroxide - Dicumyl Peroxide	44
2.9.3	Hydrolysis Condensation Catalyst	45
2.9.4	Phenolic Antioxidants	46
2.10	Influence of Blend Components on the Crosslinking Reaction	46
2.10.1	Fillers	46
2.10.2	Plasticizers, Extender Oils And Wax	47
2.10.3	Antioxidants	47
3	METHODOLOGY	49
3.1	Materials	49
3.1.1	High Density Polyethylene	49
3.1.2	Additives	49
3.2	Chemical and Blend Formulations	51
3.2.1	Selection of HDPE	51
3.2.2	Selection of Organosilane	51
3.2.3	Selection of Radical Initiator	52
3.2.4	Selection of Catalyst	52
3.2.4	Selection of Antioxidant	52
3.3	Mixing Procedures	53
3.3.1	Preparation of Chemical Liquid Mixture	53
3.3.2	Dry Blend of Compounds	53

3.4	Sample Preparation	63
3.4.1	Extrusion Blow Molding Process	64
3.4.2	Curing	66
3.5	Characterization And Testing	67
3.5.1	Density Test	68
3.5.2	Melt Flow Rate	69
3.5.3	Tensile Test	70
3.5.4	Accelerated Thermal Aging Test	71
3.5.5	Hot Set Testing	72
3.5.6	Degree of Crosslinking-Gel Content Test	74
3.5.7	Fourier Transform Infrared Spectroscopy Analysis	75
3.5.8	Differential Scanning Calorimetry (DSC) Measurements	76
3.5.9	Thermogravimetric Analysis (TGA) Measurements	78
3.5.10	Methanol Wash Test	78
3.5.11	Oxidative Induction Time (OIT) Mesuarement	79
4	RESULTS AND DISCUSSION	80
4.1	Selection of HDPE Type	80
4.2	Selection of Organo Silanes	81
4.2.1	Influences of Crosslinker Type and Concentration	81
4.3	Selection of Radical Initiator Type	84
4.3.1	Effect of Peroxide Initiator Type and Concentration	86
4.4	Selection of Crosslinking Catalyst	95
4.5	Selection of Antioxidant System For Crosslinkable Polyethylene	97

4.5.1 Aspect Regarding The Selection of Antioxidants.	97
4.5.2 Retardation Of Crosslinking Reaction of HDPE With Antioxidants.	103
4.6 Investigation of Curing Reaction of Silane Grafting HDPE.	104
4.7 Shelf Life of Silane Crosslinkable Compound	118
4.7.1 Packaging and Storage	118
4.7.1.1 Physical -Chemical Analysis	120
4.7.1.2 Methanol Wash Test-Chemical - Analysis	120
4.7.1.3 Hot Set Test Analysis(IEC 811)	122
4.8 Characterization of Crosslinked HDPE	124
4.8.1 Reaction Mechanisms of Thermo chemical Crosslinking	124
4.8.2 Characterization of Silane-Grafted HDPE By FTIR	127
4.8.3 Hot Set Testing-Molecular Structure	129
4.9 Physical Properties of Crosslinked HDPE	130
4.9.1 Density	130
4.9.2 Thermal Stability -Thermogravimetric Analysis	131
4.9.3 Melting Behavior-DSC	136
4.10 Tensile Properties of Crosslinked HDPE	141
5 CONCLUSION AND FUTURE WORKS	146
5.1 Overall Conclusions	146
5.2 Future Work	149
REFERENCES	151

LIST OF TABLES

TABLE NO.	TITLE	PAGE
2.1	The density ranges of polyethylene	13
2.2	Effect of changes in density and melt index on polyethylene properties	19
2.3	Parameters impacting on the properties	20
2.4	Changes in properties of polyethylene after crosslinking	27
2.5	Comparison of several crosslinking methods	38
3.1	Material and additives specifications	50
3.2	Selection of HDPE	55
3.3	Selection organosilane	56
3.4	Selection of type of peroxide(I)	57
3.5	Selection of type of peroxide(II)	58
3.6	Selection of type of peroxide(III)	59
3.7	Selection of Catalyst	60
3.8	Selection of type of Antioxidant(1)	61
3.9	Selection of type of Antioxidant(II)	62
3.10	Operating conditions on blow moulding machine	64
3.11	Summarized of crosslinkable compound characterization test	67
4.1	Type of HDPE used in the research	81
4.2	Characteristics of peroxide initiators	85

4.3	Derivatograph data on thermal stability of peroxides and their half-life time in hydrocarbon environment	88
4.4	Effect of peroxide on efficiency of grafting and melt flow index of silane crosslinkable compound	93
4.5	Structure of antioxidant tested	100
4.6	Initial crosslinking rates (%/hour) at various crosslinking temperatures for two different thicknesses of silane-grafted HDPE samples	111
4.7	The gel contents (%) of two different thicknesses of silane-grafted HDPE samples after crosslinking for 50 h at various temperatures	112
4.8	Methanol wash and visual inspection testing results	119
4.9	Blend formulation effect of DCP in the presence of antioxidant	125
4.10	The two concentration (DCP and VTMO) effect of gel content and the mechanical properties	145

LIST OF FIGURES

FIGURE NO	TITLE	PAGE
2.1	Structure of ethylene.	8
2.2	The bond between the two carbon atoms has opened	9
2.3	Part of a polyethylene chain or molecule	9
2.4	Polyethylene chain with side branches	9
2.5	Simplified presentation of crosslinked polyethylene molecules	10
2.6	Crystalline (A) and amorphous (B) regions in polyethylene	12
2.7	Chain structure of polyethylene	14
2.8	Polyethylene product range	15
2.9	Schematic representation of molecular weight distribution	17
2.10	Evolution of stress cracking resistance and rigidity relative to density	21
2.11	Polyethylene-The molecule	22
2.12	Part of a linear polymer chain, showing the side branch structure when butane (A) or hexane (B) or octane (C) is incorporated	22
2.13	Stacked lamellar morphology of melt-crystallized polyethylene	23
2.14	Molecular effect on ESCR	24
2.15	Rapid change of elongation with density	24

2.16	Polyethylene crosslinking technologies	31
2.17	Beta irradiation crosslinking technique	32
2.18	Peroxide crosslinking technique	34
2.19	Silane crosslinking technique	36
2.20	Schematic of the reaction mechanism for the grafting of VTMO to HDPE polymer chains in the presence of peroxide and heat during reactive extrusion	40
3.1	Laboratory scale fielder mixer	54
3.2	A schematic diagram of Magic® blow-moulding single screw extruder	63
3.3	A schematic diagram of an extruded bottle	65
3.4	Extrusion blow molding process	65
3.5	A schematic diagram of Techne® density gradient column, model DC-4	68
3.6	A schematic diagram of melt flow indexer	69
3.7	Specimen dimension for tensile testing (ASTM D638M Type IV)	70
3.8	Instron universal tensile machine model 5567	71
3.9	Ceast heat aging oven type 1175	72
3.10	Specimen dimensions for hot set test (IEC 540-85)	74
3.11	A schematic diagram of hot set testing	74
3.12	Gel content testing apparatus	75
3.13	Perkin Elmer Spectrum 2000 Explorer FT-IR Spectrometer	76
3.14	Perkin Elmer Differential Scanning Calorimeter Analyses	77
3.15	Perkin Elmer Thermogravimetric Analyser TGA	78

4.1	Effect of type and concentration of crosslinker on gel percentage at DCP: 0.2 phr, DBTL:0.01phr. (The single-screw extruder was operated at 17 rpm and melt temperature 175 °C)	82
4.2	Effect of type and concentration of crosslinker on melt flow index at DCP :0.2 phr, DBTL :0.01 phr	83
4.3	Effect of various peroxide concentration on gel content at VTMO: 2.0 phr, DBTL :0.01 phr. (The single-screw extruder was operated at 17 rpm and melt temperature 175 °C)	90
4.4	Effect of various peroxide concentration on melt flow index of grafted HDPE at VTMO: 2.0 phr, DBTL :0.01 phr.	90
4.5	Effect of screw speed of rotation and average resident times on gel content of crosslinked HDPE at VTMO: 2.0 phr, DBTL :0.01 phr	92
4.6	The effect of the DBTL concentration on the crosslinking speed at VTMO:2.0 phr, DCP:0.2 phr	96
4.7	The scorch time plotted against the concentration by weight percent (wt %) of antioxidants	101
4.8	The oxidation induction time (min) plotted against the DCP content (phr) with fix amount (0.3 wt %) of antioxidants	102
4.9	The effect of type of antioxidant and concentration on the gel content	103

4.10	Plots of the gel contents of the 1.8-phr silane-grafted HDPE bottle samples with 0.5 ± 0.05 mm in thickness as a function of crosslinking time at (A) 30°C, (B) 60°C, (C) 80°C, (D) 95°C, (E) 100°C and (F) stream(1bar)	105
4.11	Plots of the gel contents of the 1.8-phr silane-grafted HDPE bottle samples with 1.00 ± 0.05 mm in thickness as a function of crosslinking time at A) 30°C, (B) 60°C, (C) 80°C, (D) 95°C, (E) 100°C and (F) stream(1bar).	105
4.12	Plots of the gel contents of the (A) 1.6-phr, (B) 1.8-phr, and (C) 2.0-phr silane-grafted HDPE samples with 0.5 ± 0.05 mm in thickness as a function of crosslinking time at 60°C	106
4.13	Plots of the gel contents of the (A) 1.6-phr, (B) 1.8-phr, and (C) 2.0-phr silane-grafted HDPE samples with 0.5 ± 0.05 mm in thickness as a function of crosslinking time at 80°C	107
4.14	Plots of the gel contents of the (A) 1.6-phr, (B) 1.8-phr, and (C) 2.0-phr silane-grafted HDPE samples with 0.5 ± 0.05 mm in thickness as a function of crosslinking time at 100°C	107
4.15	Plots of the gel contents of the (A) 1.6-phr, (B) 1.8-phr, and (C) 2.0-phr silane-grafted HDPE sample with 0.5 ± 0.05 mm in thickness as a function of crosslinking time at 105°C	108
4.16	DSC thermograms with the area integration of the endothermic peak from (A) 60°C, (B) 70°C, (C) 80°C, (D) 90°C, (E) 100°C, (F) 105°C, (G) 120 °C to 140°C for the 1.8-phr silane-grafted HDPE sample	109

4.17	Plots of the crosslinking rates as a function of the content of crystalline component for the 1.8-phr silane-grafted HDPE samples with (A) 0.5 ± 0.05 mm and (B) 1.0 ± 0.05 mm thickness	114
4.18	Plots of the gel contents as a function of the content of crystalline component for the 1.8-phr silane-grafted HDPE samples with (A) 0.5 ± 0.05 mm and (B) 1.0 ± 0.05 mm thickness	115
4.19	Plots of logarithmic crosslinking rates as a function of reciprocal absolute temperature for the 1-phr silane-grafted HDPE samples with (A) 0.50 ± 0.05 mm and (B) 1.0 ± 0.05 mm thickness	117
4.20	Permeation of moisture through the packaging material	121
4.21	FTIR spectrum of Bis (tributyltin) oxide from the mechanical fine additive residue	122
4.22	FTIR spectrum of 3-chloropropyl trimethoxysilane from the soluble additive residue	122
4.23	Crosslinking reaction scheme for polyethylene with DCP and antioxidant	126
4.24	FTIR spectra of crosslinked HDPE containing 2.0 phr VTMO and 0.01 phr DBTL with various concentration of DCP –(A) 0.5 phr, (B) 0.4 phr, (C) 0.2 phr and (D) 0.1 phr, followed by crosslinking with boiled water for 5 hours	128
4.25	FTIR spectra of crosslinked HDPE containing 0.3 phr DCP and 0.01 phr DBTL with various concentration of VTMO (1.6,1.7, 1.8,1.9 and 2.0 phr), followed by crosslinking with boiled water for 5 hours	128

4.26	The relationship on the hot set test against its gel content. Δ - silane polyfunctional crosslinked PE, \square - peroxide initiator crosslinked PE.	129
4.27	Density of various formulations with constant processing condition (Melt temperature= $175\pm 5^{\circ}\text{C}$)	131
4.28	Effect of crosslinking on the thermal stability of crosslinked high density polyethylene	132
4.29	TGA thermogram of decomposition temperature of crosslinked HDPE (a) Neat HDPE, (b) 1.6 phr VTMO, (c) 1.7 phr VTMO and (d) 1.8 phr VTMO	133
4.30	TGA thermogram of decomposition temperature of crosslinked HDPE with several of DCP concentration in phr	134
4.31	DSC thermograms shows the changes in the melting points of different crosslinked materials formulations with increasing cross linker concentration. The crosslinked HDPE containing 0.01 phr DBTL with various concentration of VTMO (1.6,1.7, 1.8,1.9 and 2.0 phr) and various concentration of DCP (0.1,0.2 and 0.3 phr), followed by crosslinking with boiled water for 5 hours	136
4.32	Changes in the melting enthalpies (ΔH , J/g) of different crosslinked materials formulations with increasing crosslinker concentration. The crosslinked HDPE containing 0.01 phr DBTL with various concentration of VTMO (1.6,1.7, 1.8,1.9 and 2.0 phr) and various concentration of DCP (0.1,0.2 and 0.3 phr), followed by cross-linking with boiled water for 5 hours	137

4.33	Changes in the degree of crystallinity of different crosslinked materials formulations with increasing crosslinker concentration. The cross-linked HDPE containing 0.01 phr DBTL with various concentration of VTMO (1.6,1.7, 1.8,1.9 and 2.0 phr) and various concentration of DCP (0.1,0.2 and 0.3 phr), followed by crosslinking with boiled water for 5 hours	137
4.34	DSC thermograms of silane crosslinked HDPE with various initiation peroxide (DCP) concentrations (A) 0.0 phr, (B) 0.1 phr, (C) 0.3 phr	139
4.35	DSC melting endothermic and crystallization exothermic for HDPE samples containing (A) 0.0 phr, (B) 0.1 phr, (C) 0.3 phr	140
4.36	Correlation of tensile strength with gel content of crosslinked HDPE	142
4.37	Elongation at break versus gel content of cross-linked HDPE	143

LIST OF SYMBOL

J/g	-	Heat of fusion
T _m	-	Melting Temperature
ΔH	-	Melting Enthalpies
rpm	-	Rotor speed
°C/min	-	Heating rate
H ₂ O	-	Water
T _g	-	Glass transition temperature.
R	-	Organo functional group
NBR	-	Nitrile rubbers
MW	-	Molecular Weight
PE	-	Polyethylene
DBTL	-	Dibutyltin Dilaurate
DCP.	-	Dicumyl Peroxide
VTEO	-	Vinyltriethoxysilane
DSC	-	Differential Scanning Calorimetry
VTMO	-	Vinyltrimethoxysilane
HDPE	-	High Density Polyethylene.

CHAPTER 1

INTRODUCTION

1.1 Introduction

Polyolefin's are the largest volume family of commercially important high-tonnage thermoplastic polymers. High-density polyethylene (HDPE) has good mechanical properties and is often used in industry. It is a partially 40 to 60% crystalline solid, melting at about 125°C, with a density in the range 0.941-0.954 g cm⁻³ [1]. It has high impact strength, low brittleness temperature, flexibility, film transparency, and outstanding electrical properties [2]. The physical properties of HDPE are functions of three independent structure variables: molecular weight, short chain branches and long chain branching. As molecular weight increases, so do tensile strength, tear strength, softening temperature and resistance to environmental stress cracking [2, 3].

Crosslinking of polyolefin's may improve their high temperature properties and extend their applications. Peroxide crosslinking, radiation crosslinking, and silane crosslinking are the three main ways of crosslinking employed industrially [4]. Both radiation and peroxide crosslinking techniques suffered some disadvantages

such as high investment cost and thickness limitation in radiation crosslinking, and the risk of pre-curing and high production cost in peroxide crosslinking.

In silane crosslinking technique, unsaturated hydrolysable alkoxy silanes are first grafted onto or copolymerized into polyolefin's, grafted (or copolymerized) products are then processed and shaped using conventional thermoplastic processing equipment, followed by catalyzed crosslinking of the shaped products in the presence of trace amounts of water. The silane crosslinking technique offers technological advantages and improvements in many useful properties of silane crosslinked polyolefin in comparison with radiation and peroxide crosslinked polyolefin's. Mori [5, 6] has reviewed the state of the art of moisture crosslinkable silane modified polyolefin's.

Although silane-modified polyolefin's have become an industrial method employed in practice, the literature concerning polyolefin crosslinking by silane grafting consists mainly of patents [5, 6]. Little data have been published on the dependence of silane grafting reactions and the properties of crosslinked polyolefin's on reaction parameters [7-13].

Crosslinking of polyolefin's may be applied to all polyolefin types; however, the vast majority of the publications are concerned with LDPE and LLDPE. Few studies concerning the crosslinking of high density polyethylene (HDPE) has been reported [14, 15, 171 and 170]. Crosslinking of HDPE (blow moulding grade) via silane grafting and moisture curing has not been reported. In other studies [16-19, 169 and 168], silane crosslinked HDPE has only been obtained under severe processing conditions and strict grafting formulation requirements such as extremely high silane and initiator concentrations.

The crosslinking reactions are generally dependent on the reaction temperature and the content of crosslinking agents. Various works have dealt with

the effect of reaction temperatures as well as the kinds and content of the crosslinking agents on the bulk properties of the polymer. Most of the previous works on the crosslinking of polyethylene are usually on low-density polyethylene (LDPE) [20,21,22,23,24 and 133] or linear low-density polyethylene (LLDPE)[25,26,27,28,29 and 30], since LDPE or LLDPE themselves can flow to some degree even after the crosslinking reaction has been completed [31,32,33,34,35 and 36]. In the case of HDPE, however, it does not flow easily after reaching some degree of crosslinking and it is hard to measure any properties in the melt state. Thus, to the best of our knowledge, no systematic work has been reported on the property change of HDPE during crosslinking. In fact, conventional screw-type extruders cannot be used for processing crosslinked polyethylene pipes and instead rams type extruders are widely used because of the limited flow ability.

The industrial applications of crosslinking especially by silane crosslinking have been used extensively for the production of heat shrinkable polyethylene films and tubes. Crosslinked polyethylene has also been used in hot water piping installation, wire and cable industries [37-42].

Blow molded HDPE is usually employed in a wide range of applications, but in the proximity of its melting temperature (T_m), mechanical properties decrease drastically, limiting its utilization for water tank and fuel tank in automotive industrial. Crosslinking of HDPE has been suggested as a solution to this problem, but since premature crosslinking is not easily controlled and mechanical and thermal stability can be adversely affected, it is still rarely used in the industry.

1.2 Problems Statement

HDPE modified with silanol groups cannot be stored or be processed according to the usual processing methods; its manufacture has to occur simultaneously with the processing.

A significant drawback to the silane crosslinking technique for moisture-cured moulding bottle is cure time. For certain moulding systems, cure times may reach 24 hours. This is the time necessary to achieve a certain degree of crosslinking. Generally measured indirectly by a mechanical test, such as hot set (hot creep).

Long cure times have a detrimental effect on the manufacturing process. Production time is lengthened and necessary plant space for both curing and storage is increased. If curing times were reduced, a boost in productivity could be realized.

The aim of this study to describe how curing takes place in moulding bottle with an emphasis on determining what processing and material variables may most influence curing reaction test. An understanding of how these factor influence reaction rate may lead to production methods for reducing overall cure time. A series of experiments are performed to ascertain the effect of key process and material factors on the degree of cure and the resulting mechanical properties. In additional, a series of tests will be used to characterize the raw materials and final polymeric products as a baseline for this study and future studies using these types of materials.

1.3 Objectives

The objectives of the research is to determine the suitable range of chemical additives and base resin for the silane crosslinkable compound formulation, in order to achieve the optimum design requirements for developing crosslinkable HDPE for extrusion blow moulding product.

1.4 Scopes

The scopes of this project are as follow:

1. Use of experimental works based on artificial scientific evaluation technique such as qualitative and quantitative analysis, chemistry theory to develop product formulation.
2. Study the effects of processing parameter and temperature on the crosslinking and cure time.
3. Study the relationships between the degree of crosslinking and hot set.
4. Study the effect of chemical additives concentration (Vinyltrimethoxysilane, dicumyl peroxide and dibutyltin dilaurate) on :
 - a. Density.
 - b. Melting temperature
 - c. Heat of fusion (ΔH_f)
 - d. Heat of crystallisation (ΔH_c).
 - e. Decomposition temperature.
 - f. Tensile strength and elongation at break.
 - g. Degree of crosslinking.
 - h. Oxidative Induction Time (OIT).
 - i. Shelf life of silane crosslinkable HDPE Compound.

CHAPTER 2

LITERATURE REVIEW

2.1 Scope

This chapter reviews the history, structure and the fundamental properties of polyethylene. A basic understanding of the physical and chemical nature of polyethylene and of its engineering behavior is very important for the proper design and installation of this material [42 and 43].

2.2 History of Polyethylene

The Imperial Chemical Company (ICI) in England first invented polyethylene in 1933[44]. ICI did not commercialize the production of polyethylene until 1939 when the product was used to insulate telephone cables and coaxial cables, the latter being a very important element in the development of radar during World War II. The early polymerization processes used high-pressure (14,000 to 44,000 PSI) autoclave reactors and temperatures of 93 to 316° C. The polyethylene that came from these reactors was called 'high pressure polyethylene'. It was produced in a free radical chain reaction by combining ethylene gas under high pressure with peroxide

or a trace amount of oxygen. The original process was dangerous and expensive, so other safer and less expensive processes were developed. Polyethylene produced at low pressure was introduced in the 1950's. These methods also afforded greater versatility in tailoring molecular structures through variations in catalysts, temperatures, and pressures.

2.3 Manufacture of Polyethylene

Because polyethylene (PE) is one of the largest volume thermoplastic polymers yet structurally one of the simplest, understanding and controlling degradation during melt processing is the object of considerable effort in both industry and academic. PE global consumption in 2002 was approximately 6,010 million pounds [45]. PE is manufactured via several different processes [4], including:

- High-pressure free-radical polymerized low-density polyethylene (LDPE) made in autoclave and tubular reactors.
- Low-pressure Ziegler-catalyzed ethylene (-olefin copolymers such as ethylene-1-butene, ethylene-1-hexene, and ethylene-1-octene copolymers, collectively referred to as linear low-density polyethylene (LLDPE), which are made in both solution and gas phase reactors.
- High-density polyethylene (HDPE), including Phillips-process chromium-oxide-catalyzed products and Ziegler-catalyzed solution and slurry reactor products.
- New families of polyolefin are based on metallocene catalysts that are under development.

The manufacturers of HDPE by gas phase polymerization in Malaysia are: Titan Polyethylene Malaysia Sdn Bhd [46] and Polyethylene Malaysia Sdn Bhd.

2.4 The Chemistry of Polyethylene

The physical properties of a polyethylene resin are mainly exclusively dependent on basic molecular properties such as short chain branching, average molecular weight and molecular weight distribution [47]. These basic properties in turn are controlled by the size, structure, and uniformity of the polyethylene molecules. Ethylene is a gaseous hydrocarbon composed of two carbon atoms and four hydrogen atoms, C_2H_4 , arranged as indicated in Figure 2.1.

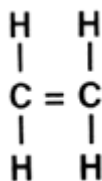

Figure 2.1: Structure of ethylene.

The two carbon atoms in the ethylene molecule are held together by a strong bond characteristic for some hydrocarbons. Under certain conditions, however, this bond will "open" as shown in Figure 2.2. This enables an ethylene molecule to join with others to form a chain in which all the carbon atoms are linked. Such a chain of ethylene molecules is called polyethylene. Polyethylene chains are not flat or two-dimensional, as Figure 2.3 appears to indicate. They have a three-dimensional shape, the hydrogen atoms being arranged along an inner zigzag chain of carbon atoms. Polyethylene chains may be rather short or enormously long and consist of many thousands of atoms. In fact, the polymerization of ethylene creates a mixture of chains of unequal length; some of them may be very short, about 12 molecules or less, while others are giants containing several hundred thousand ethylene units.

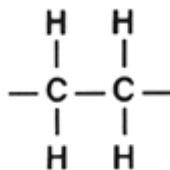

Figure 2.2: The bond between the two carbon atoms has opened

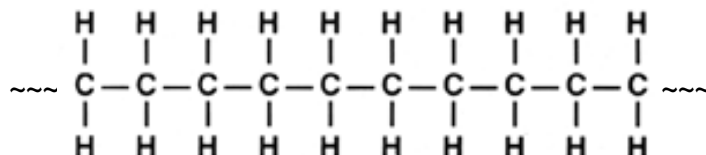

Figure 2.3: Part of a polyethylene chain or molecule.

There is no commercial polyethylene that is built up exclusively of chains as simple as the one presented in Figure 2.3. The molecular structure of most commercial low-density polyethylene resins is far more complicated. Laboratory examination has revealed that for every 100-ethylene unit in the molecular chain there are roughly 1- 10 branches (some of them other than ethylene) growing from the chain. The molecule therefore is not a straight chain but one with a great number of short and long side branches. Figure 2.4 shows a schematic picture of such a side branching chain; the branches radiate three-dimensionally, just as the branches of a tree point in all directions from various places along the trunk.

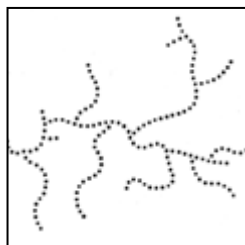

Figure 2.4: Polyethylene chain with side branches.

The presence of such side branches is a reason for variations in a number of important physical properties (such as density, hardness, flexibility or melt

viscosity), which distinguish polyethylene resins. Chain branches also become points in the molecular network where oxidation may take place. Chain branching is not the only complication in the molecular structure; crosslinking (Figure 2.5) is another. Such linking takes place between carbon atoms in neighboring chains. A network of crosslinked molecular chains may be compared to a number of heavily branched trees joined together somewhere along their branches, a highly intricate, three-dimensional molecular structure.

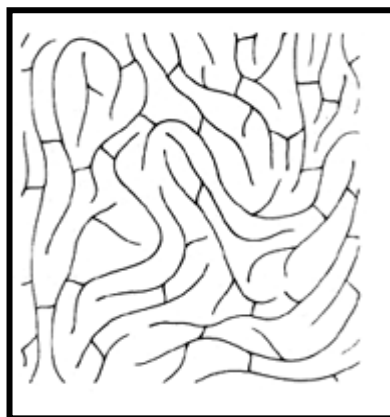

Figure 2.5: Simplified presentation of crosslinked polyethylene molecules.

Intentionally crosslinked polyethylene or polyethylene copolymer resins are useful for wire and cable coating. Resins of this type may be compounded with a very high content of carbon black or other fillers. Controlled crosslinking results in a resin with outstanding physical and heat resistant properties without impairing other essential properties. However, by crosslinking the polyethylene molecules, the polymer is changed from a thermoplastic to a thermoset and thus cannot be softened and reused.

2.5 Polymer Characteristics

Polyethylene resins can be described by three basic characteristics that greatly influence the processing and end-use properties – density, molecular weight, and molecular weight distribution. The physical properties and processing characteristics of any polyethylene resin require an understanding of the roles played by these three major parameters [50].

2.5.1 Order and Disorder in Polyethylene

Polyethylene molecules are not all arranged parallel to each other. In some areas of the plastic mass the molecular chains, though branched, are closely packed and lined up parallel in an orderly crystalline fashion. In other areas, the chains are randomly arranged like boiled spaghetti. This structure is what the chemist calls amorphous. Above its melting point, polyethylene is always an amorphous mass [51].

A polyethylene, which remains totally amorphous at room temperature, would be soft and greasy and thus useless for extrusion or moulding applications. A totally crystalline polyethylene, on the other hand, would probably be too hard and brittle to be useful. The right mixture of crystalline and amorphous regions is what the processor needs to make good end products. Figure 2.6 shows schematically the distribution of crystalline and amorphous areas. Low and medium density polyethylenes made by the high pressure process generally have crystallinities ranging from 40 to 60%. High-density polyethylene resins consist of molecular chains with only a few occasional branches. Therefore, the chains can be packed more closely. The result is higher crystallinity; up to 80% [48]. An increase in crystallinity has an influence on some essential properties. The higher the degree of crystallinity, the denser the polymer [49]. Density, in turn, favorably influences a host of end product properties. One of these effects is easy to understand; since there

is less space between the more closely packed molecular chains, articles made of more highly crystalline or denser polyethylene are less permeable to gases and moisture. Gases and moisture penetrate more readily through the amorphous areas.

Perhaps equally as important as the amount of crystallinity are the size and size distribution of the crystalline regions. Although information in this area of polymer chemistry is still limited, it is known that changes in size and size distribution of crystalline regions in polyethylene will affect stress crack resistance, brittleness and other properties. Generally speaking, it has been found that for a given amount of crystallinity in a polyethylene, a uniform distribution of small crystalline areas will result in the most favorable properties for most applications.

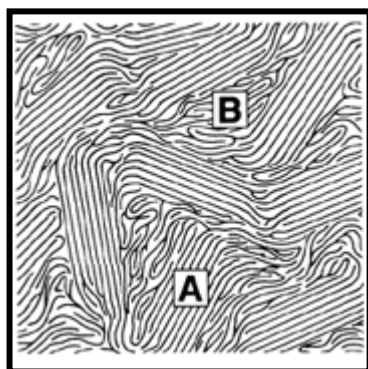

Figure 2.6: Crystalline (A) and amorphous (B) regions in polyethylene [1].

2.5.2 Basic Molecular Properties Affect Resin and End Product Properties.

Three basic molecular properties—branching (both short and long chain), molecular weight (MW), and molecular weight distribution (MWD) affect most of the mechanical and thermal properties essential for processing polyethylene and obtaining good end products. Small variations in the molecular structure may improve or impair some of these properties considerably. The electrical properties of a polyethylene resin, on the other hand, are only slightly affected by these three basic molecular factors. Polyethylene resins are currently available across a broad range of densities, about 0.91 g/cm^3 to 0.96 g/cm^3 . A classification dividing polyethylene

resins into five ranges of density is generally used by the ASTM D1248 [52]. These ranges are shown in Table 2.1.

Table 2.1: The density ranges of polyethylene

Density	Unit : g/cm ³	ASTM D1248 designation
Very Low	0.910	-
Low	0.910 - 0.925	Type I
Medium	0.926 - 0.940	Type II
High (linear)	0.941 - 0.959	Type III
Very High	0.959 and above	Type IV

Type I is a low-density resin produced mainly in high-pressure processes. Also contained within this range are the linear-low-density polyethylene's (LLDPE), which represent a recent development in the polyethylene area using low-pressure processes. Type II is a medium density resin produced either by low or high-pressure processes. Types III and IV are high-density polyethylene's. Type III materials are usually produced with a small amount of a co monomer (typically butene or hexene) that is used to control chain branching. Controlled branching results in improved performance in applications where certain types of stresses are involved. Type IV resins are referred to as homopolymers since only ethylene is used in the polymerization process, which results in least-branched and highest-possible-density material. Figure 2.7 depicts the various molecular structures associated with each type of polyethylene.

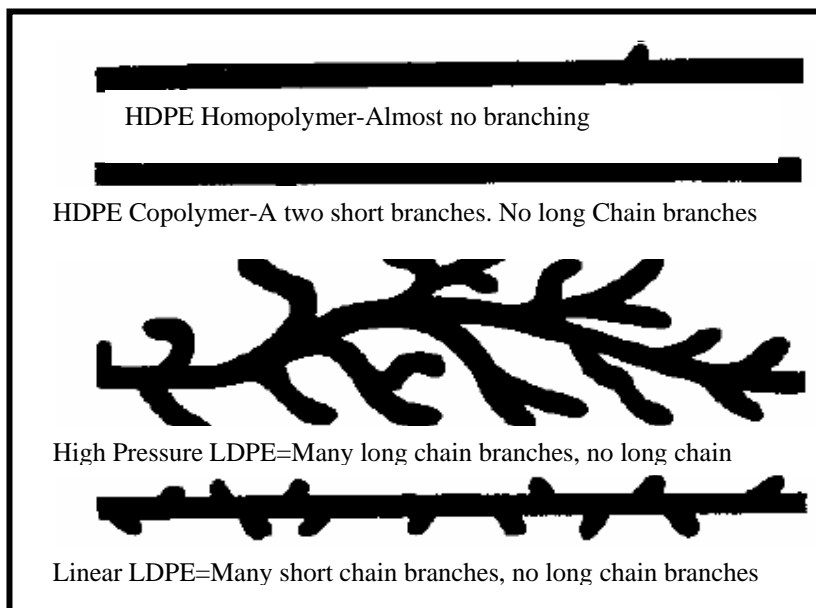

Figure 2.7: Chain structure of polyethylene [4].

Applications for various kinds of PE's are shown in Figure 2.8 with density and melt index as the key parameters. Although not shown here, molecular weight distribution and comonomer type are other basic variables used to tailor polyethylene products for specific end-uses [54]. To meet the performance requirements of these applications, dozens of manufacturers make hundreds of different grades of PE. These grades are differentiated on the basis of molecular weight (MW), molecular weight distribution (MWD), density, co monomer, co monomer content and distribution, short chain branch (SCB) and long chain branch (LCB) content and distribution, and additive content. These variations in polymer composition produce wide variations in performance, including variations in susceptibility to degradation and the consequences thereof.

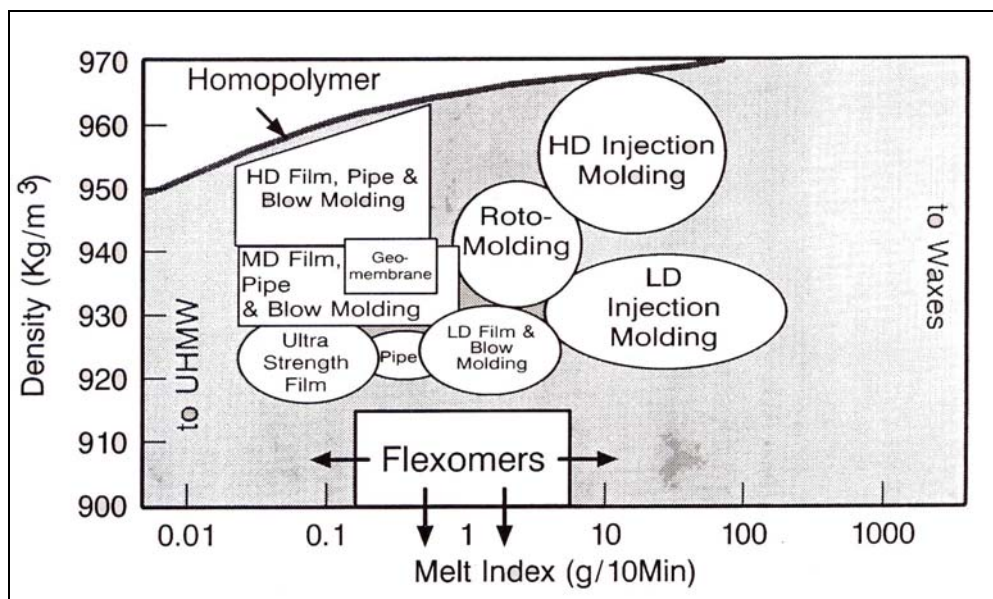

Figure 2.8: Polyethylene product range [53]

2.5.3 Effect of Changes In Molecular Weight

Every polyethylene consists of a mixture of large and small chains consisting of molecules of high and low molecular weights. Molecular weight exerts a great influence on the process ability and the final physical and mechanical properties of the polymer. Thermoplastics for piping systems are of high molecular weight (over 100,000) but not so high as to hamper shaping during manufacture or subsequent operations such as heat fusion [48].

Molecular weight is controlled during the polymerization process. The amount of length variation is usually determined by catalyst, conditions of polymerization, and type of process used. During the production of polyethylene, not all molecules grow to the same length. Since the polymer contains molecules of different lengths, the molecular weight is usually expressed as an average value. There are various ways to express average molecular weight, but the most common is the number average (M_n) and weight average (M_w). The definitions of these terms are as follows [49]:

$M_n = \text{Total weight of all molecules} \div \text{Total number of molecules}$

$M_w = (\text{Total weight of each size}) * (\text{respective weights}) \div \text{Total weight of all molecules.}$

Molecular weight is the main factor that determines the durability, long-term strength, toughness, ductility and fatigue (endurance improve as the molecular weight increases). The current grades of highly durable materials result from the high molecular weight of the polymer. Melt flow rate is a rough guide to the molecular weight and processability of the polymer. This number is inversely related to molecular weight. Resins that have a low molecular weight flow through the orifice easily and are said to have a high melt flow rate. Longer chain length resins resist flow and have a low melt flow rate.

In other words, as average molecular weight increases melt index decreases, and vice versa. Generally, polyethylenes most suitable for blow moulding applications should have a melt index in the range of 0.3g/10 min. to 1.0 g/10 min.

2.5.4 Effect of Molecular Weight Distribution on Properties

The distribution of different sized molecules in a polyethylene polymer typically follows the bell shaped normal distribution curve described by Gaussian probability theory. As with other populations, the bell shaped curve can reflect distributions ranging from narrow to broad. A polymer with a narrow molecular weight distribution (MWD) contains molecules that are nearly the same in molecular weight. It will crystallize at a faster, more uniform rate. This results in a part that will have less warpage. A polymer that contains a broader range of chain lengths, from short to long is said to have a broad MWD. Resins with this type of distribution have good environmental stress crack resistance (ESCR), good impact resistance, and good processability [48-50, 59].

Polymers can also have a bimodal shaped distribution curve which, as the name suggests, seem to depict a blend of two different polymer populations, each with its particular average and distribution. Resins having a bimodal MWD contain both very short and very long polyethylene molecules, giving the resin excellent physical properties while maintaining good processability. Figure 2.9 shows the difference in these various distributions.

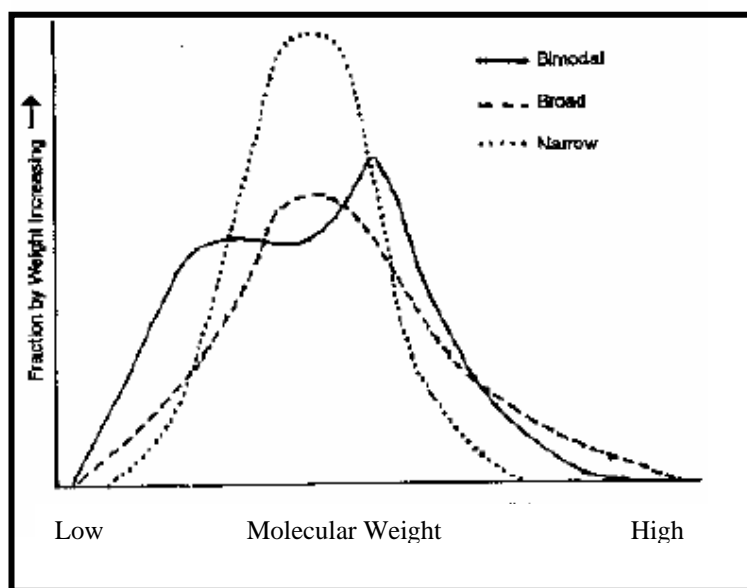

Figure 2.9: Schematic representation of molecular weight distribution.

MWD is very dependent upon the type of process used to manufacture the particular polyethylene resin. For polymers of the same density and average molecular weight, their melt flow rates are relatively independent of MWD. Therefore, resins that have the same density and MI can have very different molecular weight distributions [54].

2.5.5 Effect of Density and Molecular Weight on Polyethylene Properties

Table 2.2 shows density and molecular weight affect essential properties of polyethylene. There are some properties, which are definitely not influenced by either of these basic molecular factors, but depend upon other peculiar traits of the molecular structure, such as molecular weight distribution or configuration. There are possibly others for which such influence may be proved at some later date. The end use will determine which properties are most essential and which polyethylene resin is best suited for a particular end use.

Melt index, although customarily used for classifying polyethylene resins, is not always a reliable guide with regard to processability and specific resin and end product properties. Sometimes there is little relationship between melt index and the suitability of a polyethylene for a specific application. Melt index must be used in conjunction with other yardsticks to describe the flow and mechanical properties of a resin.

Table 2.2: Effect of changes in density and melt index on polyethylene properties.
[55 and 56]

Physical Properties	Basic Molecular Properties	
	If density increases (Note 1)	If melt index increases (Note 2)
Melt viscosity	-	Lower
Vicat softening temperature	Much higher	Lower
Surface hardness (abrasion resistance)	Higher	Slightly lower
Tensile strength:		
Yield	Much higher	Slightly lower
Break	Slightly lower	Lower
Elongation	Lower	
Resistance to creep	Higher	Slightly lower
Flexural stiffness	Much higher	Slightly lower
Flexibility	Lower	-
Resistance to brittleness at low temperatures	Lower	
Resistance to environmental stress cracking	Lower	
Barrier Properties:		
MVT rate	Lower	-
Gas and liquid transmission	Much lower	-
Grease resistance	Much higher	Slightly lower
Substrate adhesion (Note 3)	Slightly lower	Slightly higher
Shrinkage	Higher	Lower
Warpage	Slightly higher	Lower
Electrical properties	Slightly higher	No effect
Notes:		
1. For density (or crystallinity) increase within the range 0.915 to 0.965.		
2. For melt index increase or decrease in average molecular weight.		
3. Especially, physical adherence to porous substrates.		

2.5.6 Compromise between Stress Cracking Resistance and Rigidity

The relationship between stress cracking resistance and rigidity are shown in Table 2.3 and Figure 2.10 [49].

Table 2.3: Parameters impacting on the properties [49]

	Influence of the increase of the following parameter on :	Rigidity	Creep resistance	Stress Cracking Resistance
Structure of Polyethylene	Density	Higher	Higher	Lower
	Proportion of Co monomer	Lower	Lower	Higher
	Melt Index	-	Lower	Lower
Processing Conditions	Injection			
	Injection Speed	-	-	Higher
	Temperature on release of mould	Higher	Higher	Lower
	Compaction	Higher	Higher	Higher
	Extrusion Blow Moulding			
	Temperature on release of mould	Higher	Higher	Lower
	Consistent Thickness	Higher	Higher	Higher
	Radius of angle	Higher	-	Higher

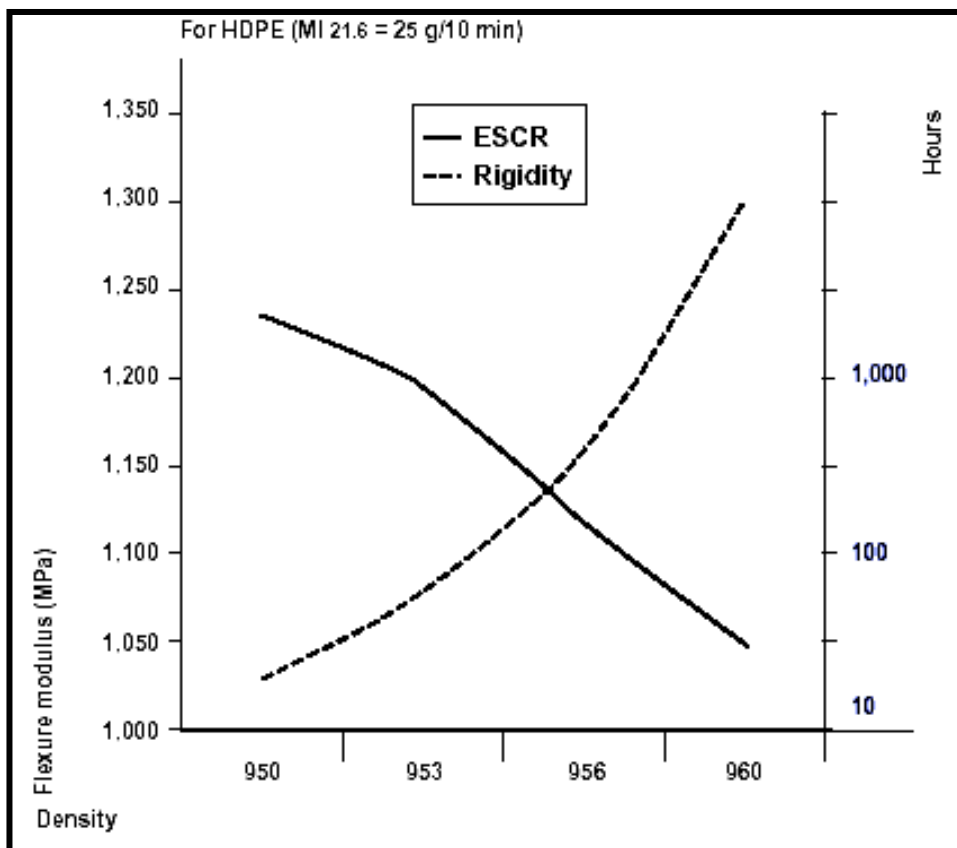

Figure 2.10: Evolution of stress cracking resistance and rigidity relative to density [57, 58].

2.5.7 Environmental Stress Crack Resistance Properties

Chemical resistance increases with density, environmental stress crack resistance (ESCR) worsens as density rises [59]. As shown in Figure 2.11, the molecular arrangement of polyethylene is a monotonous progression of connected carbon atoms, with hydrogen's filling in the vacant bonds. This is what makes PE so chemically inert and allows the chains to fold neatly into crystals. Amorphous PE consists of segments of molecules that do not fit into the crystal structure namely, chain segments that are rejected from lamellae at branch points in the chains. Thus, more branching results in more amorphous and less crystalline PE i.e. lower density. Long branches, typical of high-pressure polyethylene, can be about the length as the main chain segments, whereas short branches, found in linear PE, contain one to six carbon atoms, depending on which co monomer is used. For example, when butane

is the co monomer, the short chain branches will be ethyl groups, containing two carbon atoms. If butene-1 or hexene-1 is introduced together with the ethylene, these molecules will become incorporated into the growing polymer chain as shown in Figure 2.12.

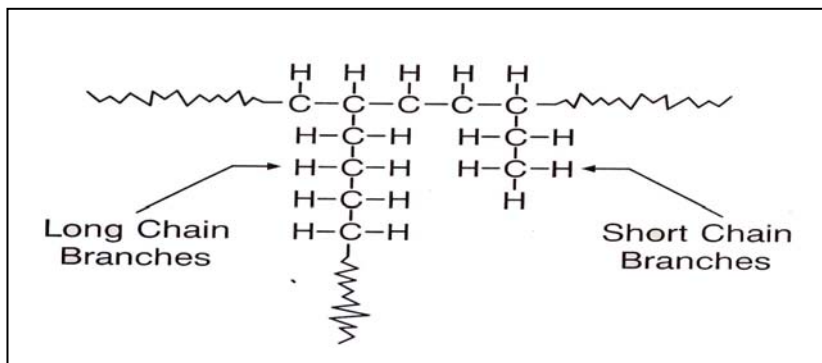

Figure 2.11: Polyethylene-The Molecule

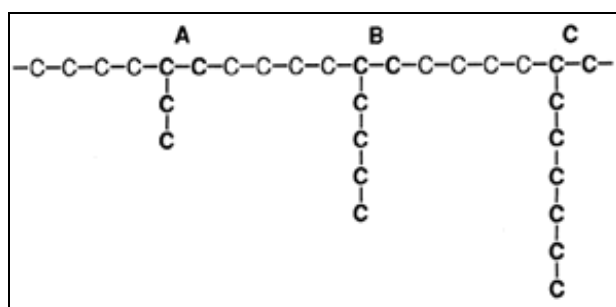

Figure 2.12: Part of a linear polymer chain, showing the side branch structure when butane (A) or hexane (B) or octane (C) is incorporated

The ethyl (C_2) and butyl (C_4) side chains interfere with the chain folding crystallization process and, as the number of side chains increases, the material exhibits a lower density. Because of its size, the butyl side chain disrupts the crystallization process more effectively than the ethyl side chain. Partly as a result of the effect on the crystallization process, hexane copolymers exhibit better stress crack/stiffness properties than the corresponding butane copolymers. This stress crack/stiffness relationship is very noticeable in thin-walled containers, for example milk bottles.

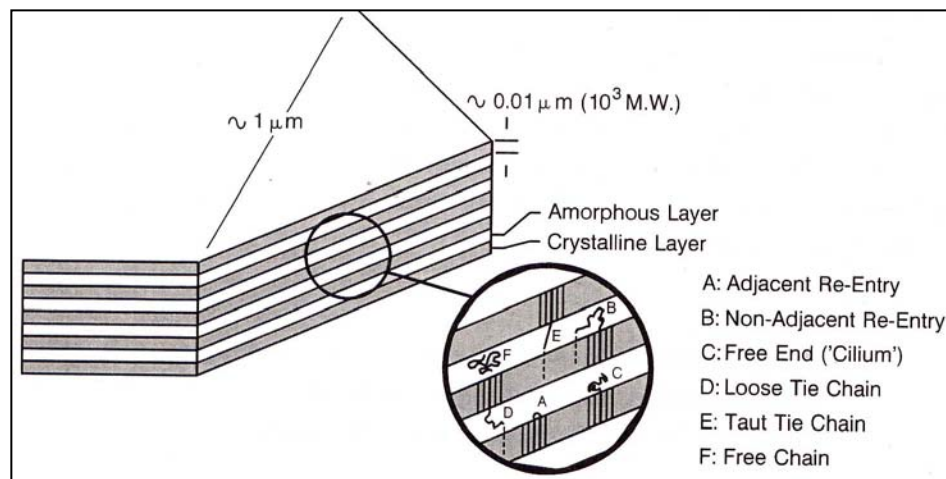

Figure 2.13: Stacked lamellar morphology of melt-crystallized polyethylene [13].

Referring to the close-up in Figure 2.13, the number of “D: Loose Tie Chains” that form chemical bonds between crystal lamellae is the crucial factor in determining a resin’s ESCR. In high pressure LDPE, a very few long branches cause most of the density reduction. Long branches are likely to become re-entry chains (A & B :). A linear resin of the same density has many more short branches that are rejected by the crystals into the amorphous regions and that can become tie chains joining the lamellae. Consequently, the ESCR of an LLDPE resin is orders of magnitude higher than that for an equivalent HD and LDPE resin.

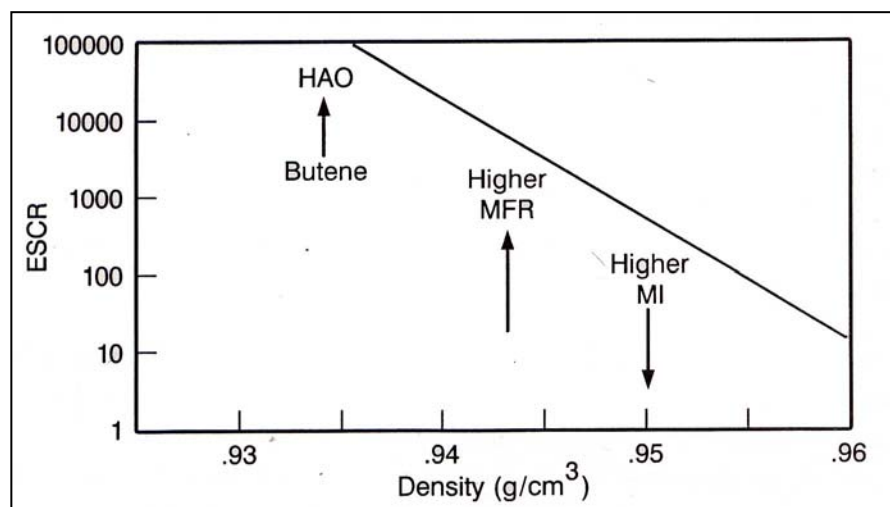

Figure 2.14: Molecular effect on ESCR

The very strong effect of density on ESCR for linear PE is shown in Figure 2.14, using data from the constant strain bent strip test. Since the polymer relaxes over time by creep and test samples do not fail, the results at low densities are just extrapolations. As density rises, the constant strain test method is increasingly severe, because the stress level is higher at equal strain for a stiffer material. Nevertheless, a large change in ESCR resulting from a small change in density is a real phenomenon.

The effects on ESCR of several other molecular PE features are represented in Figure 2.14 by the vertical arrows. (Please note that there is no significance to the placement of these arrows along the density). Co-monomer type, melt flow ratio and melt index, can also contribute a factor of ten or more to ESCR, working through the same tie chains already discussed, lower melt index means longer average molecules, which are more likely to join two crystal layers. Likewise, higher MFR is good, if the branching of molecular weight distribution is on the high molecular weight end. Again, this change provides more long molecules to act as tie chains. Finally, going from butane as the co monomer to higher alpha olefins (HAO), also improves ESCR, through the mechanism for increasing ESCR by increasing the length of the short branches is not completely understood at present.

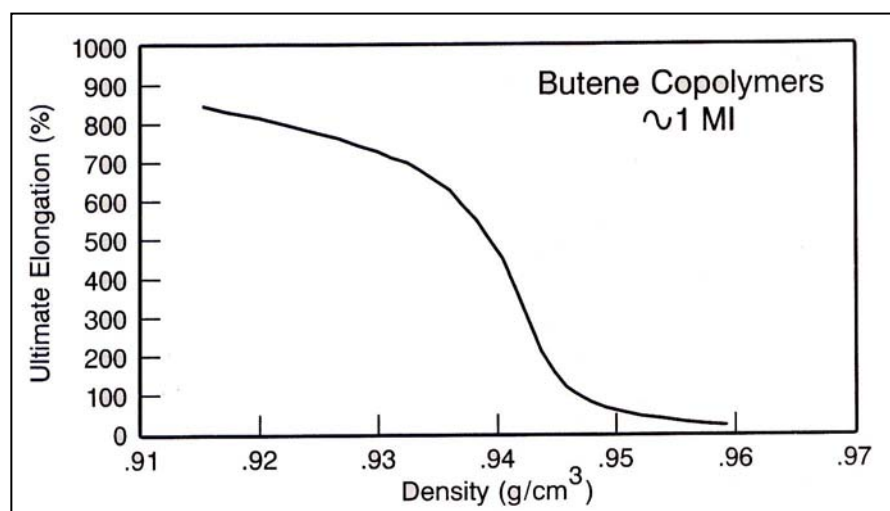

Figure 2.15: Rapid change of elongation with density

Another illustration of tie chain effects is seen in Figure 2.15, the rapid drop in elongation reflects a loss of bonding between lamellae as the tie-chain concentration falls below some critical value. Within a family of resins, the density at which this drop occurs depends upon the same molecular PE features that affect ESCR, i.e. co monomer and molecular weight distribution details. The key points are that lower density and linearity are dominant factors for excellent ESCR properties but that other aspects of molecular structure are also very important.

2.6 Overview of Crosslinked Polyethylene Technologies

2.6.1 Introduction

Polyethylene molecules do not ordinarily link to one another within the polymeric matrix. The strength, toughness, flexibility or stiffness of various grades of polyethylene depends on degrees of molecular entanglement [60]. However, there is significant interest in how chemical joining of individual polyethylene molecules alters performance of the original base resin. This chemical joining, known as crosslinking, has been used extensively in wire and cable and pipes extrusion applications. Crosslinking facilitates processability while further improving long-term performance. The technology has also become more prevalent in rotational moulding and blow moulding. Interest in crosslinking polyethylene has raised significant confusion about its nature and benefits. In literature survey, BP Solvay [61] provides the following overview of crosslinkable polyethylene technology.

2.6.2 Crosslinked Polyethylene

XLPE and PEX are the term for crosslinked polyethylene. Three principal technologies may be used to make crosslinked polyethylene products. All three methods link single strands of PE through radical reactions between the molecules to form a dense network. Generally, any of the three methods may be used to produce PEX pipe in accordance with the applicable ASTM standards, which require 65-80% degree of crosslinking [38]. The number of links between molecules determines cross-link density. It directly affects the material's physical properties. The degree and nature of crosslinking achieved by any of the three methods may be quantified by the xylene extraction process set forth in ASTM D2765 [62].

2.6.3 Crosslinking Improve Polyethylene Properties

The primary reason to crosslink polyethylene is to raise the thermal stability of the material under load. For example, pipes manufactured from high-density polyethylene (HDPE) can be assigned a pipe rating based on hydrostatic stress data obtained at different temperatures [63]. In general, continuous temperature ratings exceeding 60°C are rare. Crosslinking of polyethylene change the polymer from thermoplastics to thermosetting material. Once the crosslinking is completed, the service temperature can be raised to at least 100 °C and sometimes as high as 120 °C, depending on starting density, degree and type of crosslinking. ESCR also increases dramatically, as evidenced by improved resistance to slow crack growth. Tensile strength tends to remain the same or increase slightly, but there is a considerable drop in elongation at break. Crosslinking and subsequent chain entanglement make the PE much stiffer. At the same time, crosslinked polyethylene retains most of the desirable properties of normal polyethylene [64]. For example, the advantages of its lightweight, flexibility, good chemical resistance and non-toxicity. Several of these physical properties are summarized in Table 2.4.

Table 2.4: Changes in properties of polyethylene after crosslinking

Property	Change from HDPE to XLPE
Melt index	Decrease
Density	No changes or decrease
Molecular weight	Significantly increased
Tensile strength	No changes or increases slightly
Elongation at break	Decreases
Impact resistance	Significantly improved
Abrasion resistance	Greatly improved
Stress-crack resistance	Greatly improved
Elastic properties	Greatly improved
Environmental Stress Crack Resistance (ESCR)	Increase
Resistance to slow crack growth	Increase; higher temperature hydrostatic design basic (HDB)
Temperature resistance	Greatly improved (long term working temperature increased to 95°C)
Chemical resistance	Significant increase

2.7 Methods of Crosslinking Polyethylene

The idea of crosslinking polyethylene to achieve better properties is not new. The first commercially available crosslinking method is similar to rubber vulcanization. This method uses peroxide based chemical to create a direct carbon-to-carbon link within the polyethylene structure. Commercially available crosslinked polyethylene compound produced using this method has been used for more than 20 years. The various common crosslinking methods of polyethylene are summarized in Figure 2.16[65]. There are two broad categories of crosslinking methods for

polyethylene. One of which employs physical crosslinking while the other uses chemical agents to achieve crosslinking.

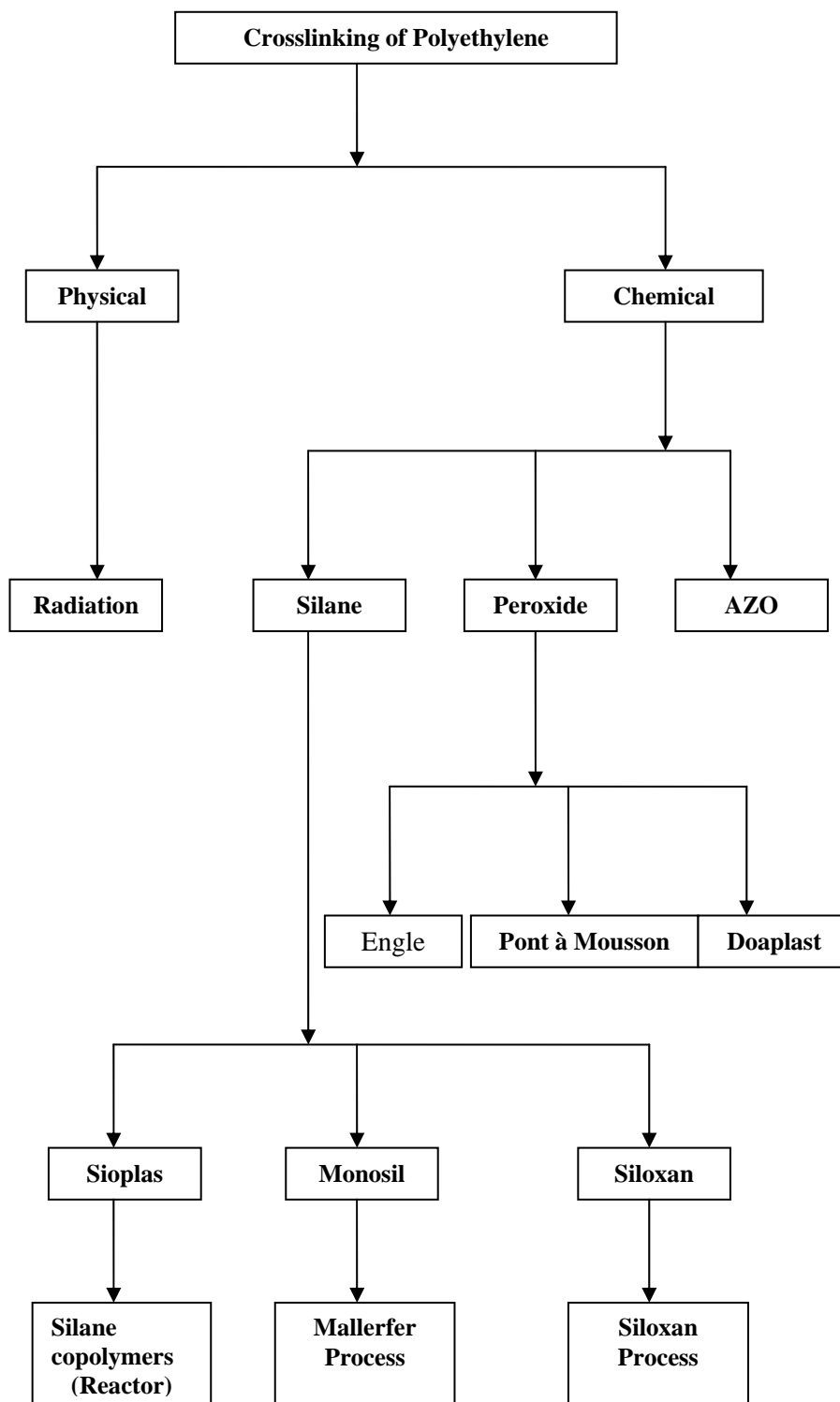

Figure 2.16: Polyethylene crosslinking technologies [66].

2.7.1 Physical Crosslinking (Radiation Method)

Radiation crosslinking is carried out on products produced by conventional extruders. The crosslinking step is affected by high-energy radiation, for example electron beams or gamma rays. The crosslinking technique is comparable with that of peroxide crosslinking but the free radicals are not produced by peroxides but by the radiation. This method uses high-energy radiation to achieve crosslinking. The PE is simply subjected to a dose of high-energy electrons to crosslink the material (Figure 2.17). Both electron beam and gamma ray can be used for crosslinking. Products of polyethylene are initially, formed by using normal thermoplastic production methods (for example, extrusion). After which, the product is subjected to radiation. The hydrogen atoms originally present in the molecules are “knocked off” from the carbon atom by the high-energy radiation, leaving behind a free radical polymeric chain. This free radical is unstable and will seek for another free radical carbon adjacent to it to form a stable bond. As irradiation progress, bonds are formed. Hence, creating a crosslinked structure.

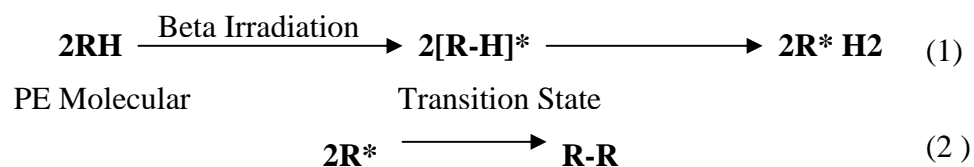

Figure 2.17: Beta irradiation crosslinking technique

This method of crosslinking can occur simply at room temperature and crosslinking takes place in the solid state [66]. However, this process has its drawback. The shortcoming is that it may have tendency towards uneven crosslinking. In many applications, the radiation crosslinking is only applied for maximum thickness of 2.5 mm. Therefore; it is restricted to products of smaller sizes. Another disadvantage of this method lies in potential nonuniformities in the crosslink density as compared to the other two crosslinking methods. Furthermore, the requirement of initial investment and running cost are significantly higher

compared to other crosslinking methods [67, 68]. Elevated costs of installation and operation, plus the somewhat elaborate precautions needed to protect personnel from radiation together with government permits required, detract from the popularity of irradiation.

2.7.2 Chemical Crosslinking

The other broad category of crosslinking method employs chemicals to achieve the bonding. Some methods form a direct carbon-carbon bond while others use a chemical bridge to connect the polyethylene molecules. The three main methods of chemical crosslinking are the peroxide method, AZO method and silane methods. The major chemical processes are described as follows:

2.7.2.1.1 AZO Method

This method of crosslinking use AZO compound (molecules with groupings of $(-N=N-)$ to perform the crosslinking. This is a two-stage method. First of all, normal thermoplastic processes form the product. The temperature of the process must not exceed the critical temperature in which AZO compound may become reactive. Thereafter, the product is being passed through a high temperature bath, which raises the temperature to allow the AZO bond to be initiated and thus, creating crosslinking.

2.7.2.2 Peroxide Method

Peroxide crosslinking uses peroxide agents [4, 69] (with a -O-O- structure) to initiate the reaction of hydrogen abstraction. In this system, the polymer is crosslinked in the presence of peroxides at high temperature. Peroxides are heat-activated chemicals that generate free radicals (initiation reaction). Radicals are carbon-based entities, which possess a free electron. The radical abstracts a hydrogen atom from one of the carbon atoms in the PE chain, leaving localized PE radical or reactive species.

This reactive species can then form a crosslinking bond with PE radical or abstract hydrogen from another PE strand creating another free radical. Two adjacent carbon atoms of such condition will form a carbon- carbon bond to achieve stability, thus, forming a cross-link. These chain termination and propagation reactions appear in a simplified form in Figure 2.18 [4, 70-72].

This process will propagate until the peroxide agent is exhausted. This method of crosslinking produces methane gas as by-product. As such, high pressure has to be applied to the product while undergoing crosslinking. Otherwise, escaping methane gas will form pores or pin holes in the product. Such pores or pinholes will cause weakness in the final product.

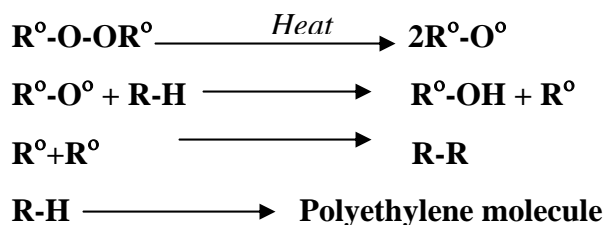

Figure 2.18: Peroxide crosslinking technique

In the extrusion processing, the decomposition temperature of the peroxide must not be exceeded at any point. Such step therefore requires extremely precise temperature and process control since otherwise pre-crosslinking in the extruder can result in deposits on the screw and stoppage of the machine. In addition, crosslinking with this method occurs in the melt-phase and as a result a considerable drop in density of the modified product is evidence.

Peroxide is either adsorbed onto PE flakes or pellets. The mixture is usually processed in a chamber containing a reciprocating piston to quickly melt the PE - Engel process [70]. The molten PE is shaped into a pipe with conventional dies. Further heating allows the peroxide to complete the crosslinking process with a conventional extruder; the heat profile must be carefully controlled to prevent premature crosslinking in the barrel, which would generate excessive pressures. In this situation, a short L/D and specially designed screw are highly desirable. Only the peroxide technique permits crosslinking in the melt phase and, as a result, a considerable drop in density of the solidified product can be seen. Temperature control of the overall process is vital. Peroxide suppliers can provide prospective users time/temperature charts to help set up process conditions.

The common variations of peroxide crosslinking are Engel method (the first commercially available crosslinking method), Pont-a Mousson method (PAM) and Daoplast method. This method has the advantage of potentially producing items that have higher cure levels than the other two crosslinking processes. Gel levels of 90% are achievable using a peroxide cure, but care must be taken because that can be too high for some applications. One major disadvantage with this method is a limitation on the number of additives (such as antioxidants) employed in the compound, as they can interfere with the reaction. In addition, stabilization systems can become more complex. Some other disadvantages of this method can include high capital investment for the equipment, the energy-intensive nature of the process, high scrap rates, low outputs, and limitations on part thickness[4, 68].

2.7.2.3 Silane Method

Silane crosslinking uses a siloxane bridge to link polyethylene molecules. There are a few variations to achieve silane crosslinking. The chemistry of this method is illustrated in Figure 2.19 [4, 68, and 72].

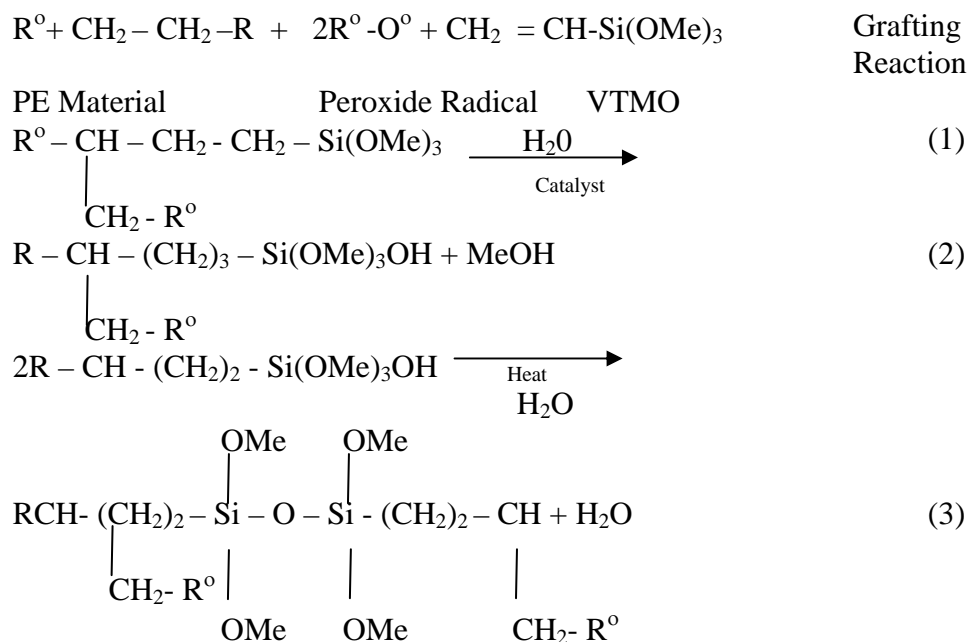

Figure 2.19: Silane crosslinking technique

The first step is the grafting of the chemical silane onto the polymeric chain to form vinyl silane copolymer. Peroxide agent again will initiate the reaction at elevated temperature and form free radicals. Free radicals of peroxide agent will abstract hydrogen from the polyethylene molecules, thus creating unstable carbon (step 1 of Figure 2.19). After which, silane is grafted onto the carbon atom to form a copolymer and the remaining free radical on the copolymer branch will continue to abstract a hydrogen atom from other polyethylene molecule to become stable (step 2 of Figure 2.19).

This abstraction of hydrogen to form a stable copolymer further propagates the action of the silane grafting. At this stage, the copolymer still remains as thermoplastic that can be processed as any thermoplastic could. The resulting of copolymer is put into the converters to form the finished product. For example, pipes or cables.

The next step requires the finished product to be cured (i.e. converting the grafted copolymer into a crosslinked network) using moisture as an active reagent. The curing involves hydrolysis and condensation reaction, which results in a molecule of water being generated, which in turn initiates another curing reaction (step 3 of Figure 2.19). This reaction continues until all the grafted copolymer is converted to cross link chains.

2.7.2.3.1 Sioplast Method

Dow Chemicals originally developed this method in 1973. In the Sioplast process [73-74], a PE resin is melted and silane is added to the melted PE along with a peroxide initiator. Crosslinking sites are thereby formed on PE polymer chains and crosslinking begins to occur. The grafted resin is palletized and stored for later use in foil-lined bags. As crosslinking of the grafted resin occurs in the presence of moisture, it is important that the grafted resin not be exposed to moisture until substantial crosslinking is desired. However, since this method of crosslinking of PE is self-perpetuating, the crosslinking reaction producing moisture as a byproduct, it is not practical to completely prevent crosslinking in the pelletized grafted PE resin and so it has a shelf life of only approximately 6 to 9 months.

A catalyst masterbatch is prepared for the grafted resin. The catalyst masterbatch typically includes a quantity of PE, a catalyst, an antioxidant, a stabilizer, and an internal lubricant. The catalyst masterbatch is typically palletized for ease of mixing with the grafted resin in a conventional extruder. The grafted resin

and catalyst masterbatch are usually combined in a specific ratio, melted and mixed together, and extruded. When the grafted PE resin and catalyst masterbatch are mixed together, crosslinking of the PE at the silane graft sites accelerates. The material exits the extruder and is typically cooled in water.

The process is referred to as "two-step" because two distinct steps are used to obtain the final crosslinked product. In the first step, the material compounder grafts silane to the polyethylene. In the second step, the processor mixes the grafted compound with a catalyst and processes it into a finished product. The process is straightforward and allows for high output rates with low scrap using conventional extrusion equipment. The compounder can tailor formulations to fill the processor's specific requirements. Sioplas practitioners have the option of purchasing the grafted PE and catalyst masterbatch from a compounding company.

2.7.2.3.2 Monosil Method

This system utilizes a one-step process to perform grafting of silane to the polymeric chain and subsequently crosslinking the product. This system, developed by Maillefer and BICC in 1978, requires a specially designed extruder with a high L/D ratio (about 30) that is more expensive than conventional PE extruders used for Sioplast process. Meanwhile, the Monosil system [75] is rather limited to small diameter pipes. This approach needs high initial investment and extensive training to operate the system. In the Monosil process all the ingredients are fed directly into special purpose extruder through a hopper. Consequently, great care is needed to achieve the grafting without excessive crosslinking as the grafting reaction occurs in the same extruder.

In this monosil one-step process, the grafting takes place during the fabrication of the product, whether it be wire, pipe, or other profile. The silane, initiator, polyethylene, catalyst, and antioxidants are all introduced in the same

operation and the extruded product begins to crosslink immediately. While this process seems simple and appears to have economic advantages, the need for special processing equipment, specialized training and equipment for handling and storage of the chemicals, and the high degree of specialization needed to manage the generation of scrap offsets this apparent advantage. Furthermore, this method can place limits on the inclusion of specialty additives required for particular applications because they can inhibit the grafting process. Thus, formulation is critical and requires specialized and experienced personnel.

2.7.2.3.3 General Variation of the Monosil Process and the Sioplas Process

Dow Chemical developed moisture-cured crosslinking in the late sixties. Two major variants, the Monosil process and the Sioplas process, have emerged. The Monosil technique introduces vinylsilane into the polyethylene during conventional extrusion of polyethylene pipe. In the Sioplas technique, however, PE resin is first compounded with vinylsilane and peroxide. This compound combines with a catalyst masterbatch, which is then fed into the extruder for conversion into pipe. In both cases, the objective is to graft a reactive silane molecule to the backbone of the polyethylene. The pipe then cures in a high-temperature water bath for several hours, or goes into a steam sauna so the material can be crosslinked. The important difference between the variants is that the Monosil process is a one-step reaction and the Sioplas process has two steps. The crosslinking mechanism is different from that of the peroxide method. Water attacks one of the methoxy (Ome) groups to generate a silanol. Two silanol groups subsequently form a new chemical bond in a condensation process that eliminates water. This crosslinking takes place in the solid state.

A problem associated with both the SioplasTM process and the MonosilTM. Process methods are the difficulty of adequately combining some or all of the silane, peroxide catalyst and hydrolysis/condensation catalyst (some or all of which are liquids) with the base polymer, which is a solid. If the silane is injected as a liquid

stream into a conventional extruder and mixed with a polymer, small gels form throughout the polymer product, apparently because of localized, premature crosslinking in areas of high additive (silane and catalyst) concentration resulting from inadequate mixing. When a silane is sprayed into a polymer, additional apparatus is required, and the silane must be sprayed uniformly. High demands are placed on the uniformity of mixing at or near the spraying point to equalize variations in concentration and ensure that the silane is distributed homogeneously. To complete the crosslinking process, the extruded material from either the Sioplas or Monosil process is generally exposed to moisture at an elevated temperature. A sauna-like environment or hot water immersion will produce the desired level of crosslinking in a relatively short period of time. When this curing stage is finished, the PE may be approximately 65-89% crosslinked.

2.7.2.3.4 Siloxan Method

This method is a one-pack system and the product consists of all chemical specially compounded into one single compound. This eliminates the need of separating the catalyst from the grafted copolymer. This method of crosslinking is much easier to use compared to other silane crosslinking methods because there is no need to mix the components prior to production (like the Sioplast method). Silane crosslinkable polyethylene is a compound (product) produced using this method. Simple comparison of several crosslinking is shown in Table 2.5.

Table 2.5: Comparison of several crosslinking methods [76].

Crosslinking Process	Silane Siloxane	Peroxide Enger	Radiation E-beam
Process Flexibility	Very Good	Small	Very Good
Operation	Easy	Difficult	Difficult
Operation Efficiency	High	Low	Medium
Extruder	Standard	Special	Standard
Output	High as For PE	Low	High as For PE
Cost Of Post Treatment	Low	-	High
Initial Investment	Low	High	High
Minimum required strength rating	High	Medium	High
Diameter	No limit, Thickness limited By speed of crosslinking	Difficult to achieve big diameter because of output	Limited by penetration depth of electrons

2.7.2.3.5 Silane Grafting Reaction Mechanism

Figure 2.20 shows a schematic of the reaction mechanism of VTMO grafting to a polymer matrix via free-radical initiation [7,145]. A three-step reaction mechanism is required to attain the desired grafted product. [149] First, the DCP must dissociate to form a peroxide radical under the extrusion conditions with melt temperature $170\pm 5^\circ\text{C}$ [148]. Peroxide radical then reacts with a polymer chain, undergoing a radical transfer to create an alcohol and a polymer radical. At this point, the polymer radical can react with the VTMO. This reaction, followed by a radical transfer, results in the formation of the desired silane graft. However, other reactions, including chain scission and direct crosslinking, are also possible [146,147,150]. The polymer radical can undergo chain scission, creating an unsaturated hydrocarbon chain, which can go on to form a chain graft with another polymer radical. Also, the polymer radical can undergo direct crosslinking with another polymer radical, terminating the reaction [150]. VTMO grafting is the desired reaction during extrusion because it allows the HDPE polymer to retain essentially the same processing characteristics while functionalizing it for post-extrusion modification. If direct hydrocarbon crosslinking occurs in the extruder, the molecular structure of the polymer matrix will be chemically fixed. This will greatly reduce the process ability of the post-extruded polymer and will limit the formation of the desired silane crosslinks.

Results for post-extruded samples prior to silane crosslinking revealed that DCP, in the absence of VTMO, initiated some direct hydrocarbon crosslinking between polymer chains. VTMO alone, however, produced no grafting to the polymer and acted solely as a plasticizer or lubricants. The presence of both DCP and VTMO resulted in a competition between silane grafting and direct hydrocarbon crosslinking. However, sufficient silane grafting was produced and dependent on the reaction time or rate, temperature as is evident from DSC, gel content as shown in the FTIR measurements results.

The kinetics of crosslinking appeared to increase with increasing temperature, possibly because of the increase in the oxygen radical diffusion in the matrix with increasing temperature and the increase in the rate of oxygen radical formation. However, both the crosslinking kinetics and the extent of the elastic modulus increase (low MFI) relative to the initial value were functions of the initial DCP concentrations. An optimum DCP concentration existed that favored silane-graft crosslinking over direct hydrocarbon crosslinking.

Step1 Grafting PE + Silane + Peroxide

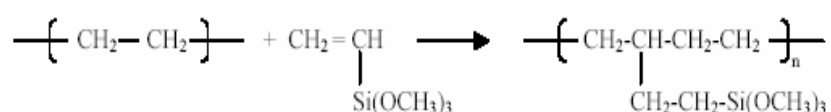

Step 2 Hydrolysis: catalyst, H₂O

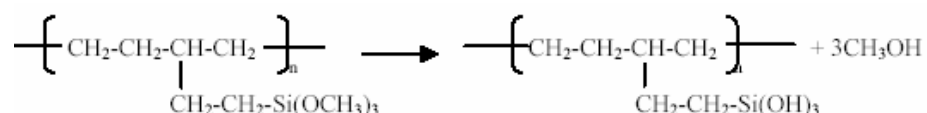

Step 3 Condensation: catalyst

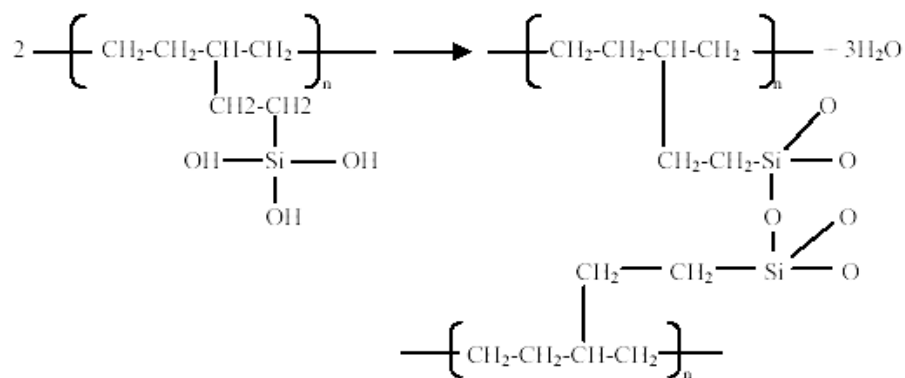

Figure 2.20: Schematic of the reaction mechanism for the grafting of VTMO to HDPE polymer chains in the presence of peroxide and heat during reactive extrusion.

2.8 Crosslinking Method Selections.

Available studies show that any of the techniques presented will generate good crosslinked products, provided the technique is followed correctly with good quality control. Choice of the technique is usually dictated by the user's needs and equipment availability. The peroxide method requires a reciprocating-piston type extruder or an extruder with suitable modifications. The technique also requires the user to safely handle peroxides. Variability of crosslinking with this method is potentially the highest. The degree of crosslinking is directly proportional to peroxide concentration, antioxidants levels, and process temperature. It is certainly the most demanding technique. Users choose it because of its one-step processing.

Vinylsilane moisture-cure techniques are less demanding and can be accomplished on most extrusion equipment. The choice among the variants gives users the option of simplifying the process even more (a trade-off between raw materials and number of steps to perform in manufacturing terms). The only drawback is that a sauna or water bath must be operated consistently to ensure the required degree of crosslinking.

At this time, in-line beta irradiation equipment remains costly. This may necessitate that pipe be transported to an off-site facility that specializes in irradiation technology. Cost for additional shipment and handling must be carefully evaluated, since the U.S. has only a few specialized facilities. Nevertheless, as the number and size of these facilities continue to increase, both the processing fee and associated transportation costs may decline. Beta irradiation also remains the only post-extrusion crosslinking technique.

Therefore, siloxan one-step process and one pack method has been selected in this study to produce silane cross-linkable HDPE for extrusion blow moulding. Through this method, silane crosslinkable olefin excellently imbalances the extrusion

processability as well as in cross-linking property, mechanical property and heat resistant property. This process has been developed to overcome the aforesaid problem of others cross-linking process or method.

2.9 Chemical Additives Used In Formulation

2.9.1 Crosslinker -Vinyltrimethoxysilane (VTMO)

The purpose of the organic unsaturated vinyltrimethoxysilane is for grafting onto the base resin to serve as the point which crosslinks the base resin molecules with each other. Hydrolysable olefinically unsaturated silanes suitable for grafting onto and crosslinking the polymers according to this invention include organofunctional silanes of the general formula [77]:

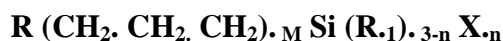

Wherein R represents a monovalent olefinically unsaturated hydrocarbon or olefinically unsaturated hydrocarbonoxy group which is reactive with the free radical sites generated in the polymer by the free radical generator. R₁ represents an hydrolysable organic group such as an alkoxy group having 1 to 12 carbon atoms (e.g. methoxy, ethoxy, butoxy), aralkoxy groups (e.g. phenoxy), aliphatic acyloxy groups having 1 to 12 carbon atoms (e.g. formyloxy, acetoxy, propionoxy), oxymo or substituted amino groups (alkyl amino and aryl amino)X represents a monovalent alkyl, aryl or aralkyl group (e.g. ethyl, methyl, propyl, phenyl, benzyl), m is 0 or 1 and n is 0, 1 or 2.

Preferably the unsaturated silanes will contain two or three hydrolysable organic groups and a vinyl or methacryloxypropyl group as the group reacting with the free radical sites formed in the polymer by the free radical generator. Some representative examples of the unsaturated silanes applicable in the crosslinking process are vinylmethyldimethoxysilane, vinyltriethoxysilane, vinyltrimethoxysilane [78].

The amount of silane crosslinker used in the practice of this research can vary widely depending upon the nature of the ethylene polymer, the silane, the processing conditions, the grafting efficiency, the ultimate application, and similar factors. Selection of the optimal silane for an application requires consideration of several factors including [79]; the resin in the formulation, the filler in the formulation. the target substrate and the cure conditions (room temperature, elevated temperature).

The amount of vinyltrimethoxysilane silane is chosen so as to be near the minimum amount needed to provide the desired degree of crosslinking. The amount of the organic unsaturated silane to be used may vary/ added commonly from 0.1-5% by weight, preferably 0.7-3% by weight, based on the total weight of polymers [77].

The concentration of vinyltrimethoxyloxysilane relating to 100 parts of base polymer should be 1.6 - 2.0 phr. When the amount is less than 1.6 parts by weight, a sufficient grafting does not take place. An amount larger than 2.0 parts by weight may cause defective moulding and also is economically disadvantageous. Lower concentration reduces the safety margin with respect to the requirements to hot set and gel content. A dosage of more than 3 parts does not significantly improve the crosslinking results [77]. These vinyltrimethoxyloxysilane is commercially manufactured by Crompton (silquest A171) [80], Degussa (Dynasylan[®] VTMO) [81] and Shin Etsu (KBM 1003) [82].

2.9.2 Peroxide - Dicumyl Peroxide (DCP).

Peroxide is to produce free radical sites in the polymer. The reaction conditions depending on temperature and retention time needed for achieving a suitable half-life time [83]. The free radical generating agent used in this research acts as an initiator of silane grafting. The general formula is; $C_{18}H_{22}O_2$ [84].

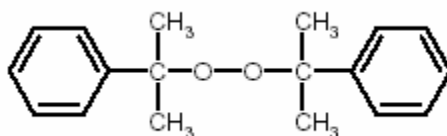

The amount of free radical generator necessary in the present invention is not narrowly critical and can be varied over wide ranges, for example, from 0.01 part to 1.0 part preferably 0.05 to 0.2 part based on the total weight of the extrudate, depending on the nature of the base polymer, the silane, the presence of stabilizers, the extrusion conditions [9]. When the amount is less than 0.01 parts by weight, the silane grafting does not proceed sufficiently. When the amount is larger than 0.5 parts by weight, both the extrusion processability and the surface appearance of mouldings tend to be poor [84]. Satisfactory mechanical properties can be obtained at the lowest dosage levels. Higher levels improve the compression set properties. The highest levels should not be exceeded, or remaining mechanical properties will be reduced [15].

The grafting conditions can vary, but the melt temperatures are typically between 160 and 200 °C, preferably between 170 and 180 °C, depending upon the residence time and the half-life of the initiator [86]. This dicumyl peroxide is commercially available from different companies with their trade name such as PERCUMYL D[®] [84], Luperox[®] DCSC [87] and Perkadox BC-FF [88].

2.9.3 Hydrolysis Condensation Catalyst - Dibutyltin Dilaurate

Hydrolysis or condensation catalysts catalyze the crosslinking of the extrudate by reaction of the extrudate with water. The catalysts may accelerate either the hydrolysis reaction of the grafted silyl groups with water to form silanols, or the condensation of silanols to form Si-O-Si bond or both. These catalysts may be Lewis acids, such as tin carboxylates, for example: dibutyltin dilaurate, dioctyltin dilaurate, stannous acetate, stannous octoate, dibutyltin dioctoate, di-octyl tin-bis (isooctylmaleate), di-octyl-tin-bis (isooctylthioglycolate). The most effective catalyst for silane crosslinking is dibutyltin carboxylates such as dibutyl tin dilaurate (DBTDL) [89].

The proportion of silanol condensation catalyst used is not narrowly critical, illustratively ranging from 0.01 to 0.2 parts, preferably 0.015 to 0.1 part based on the total weight of the polymers [91]. The standard concentration in the Siloxan Process is 0.08 phr (the lower limit is about 0.025 phr). Lower concentration than 0.025 phr lead to reductions in degree of crosslinking and require longer periods of exposure to moisture, while concentration exceeding 0.08 phr causes premature to moisture reactions during extrusion (increased melt viscosity) and may lead to processing problems. The formation of a spatial network consisting of polyethylene chains tied together by Si-O-Si linkages occurs in the second phase of the Siloxan process with the aid of moisture. The crosslinking catalyst plays an important role in this phase with respect to the degree of crosslinking that may be achieved [90].

2.9.4 Phenolic Antioxidants- Pentaerythritol Tetrakis (3-(3, 5-di-tert-butyl-4-hydroxyphenyl) Propionate [92]

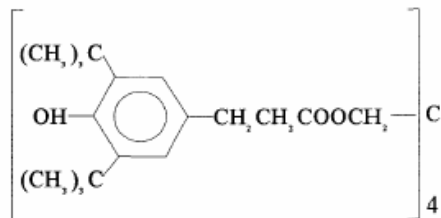

Generally, most polymer materials contain some stabilizers such as antioxidant to prevent oxidation degradation. For the crosslinking of polymers, the antioxidants are known to retard the reaction, so the selection of a suitable antioxidant has been empirical. This is often very complex, especially when a mixture of several antioxidants is used. The various classes of stabilizers that are used in crosslinkable polyethylene display a highly differing potential of interference in silane crosslinking. Phenolic stabilizers show strong interference [93]. Its concentration in crosslinkable polyethylene depends on the end use of the parts and on the protection requirement, the usual concentration ranges between 0.005-0.2 phr. [94].

2.10 Influence of Blend Components on the Crosslinking Reaction

2.10.1 Fillers

Insufficient of crosslinking reaction in presence of a number of acidic fillers, in particular silicic acids, due to the catalyzed ionic decomposition of the peroxides. The adsorption of peroxides on the surface of certain fillers such as talc and silicates also leads to the possibility of inadequate cross-linking. In such cases, this can be

remedied by increasing the peroxide quantity and/or by the addition of co agents [78,126].

2.10.2 Plasticizers, Extender Oils and Wax

With the exception of plasticized PVC, cross-linked thermoplastics do not generally contain plasticizers or extender oils. In rubbers and a number of special applications in which these auxiliaries are used, these additives reduce the cross-linking effect to a greater or lesser extent. In this respect, aromatic oils have the most adverse effect whereas a phathenic and paraffin oils exhibit only a slight effect [78].

Mtshali and colleague [96] reported that the wax and crosslink LDPE were not mutually miscible at higher wax concentrations in the crystalline phase, as well as in the melt. The thermal stability of the blends decreased with an increase in wax content. Krupa and Luyt [97] also reported that the thermal stability of crosslinked blends in synthetic air atmosphere is much lower than in nitrogen atmosphere, and they decrease with an increase of wax portion. This is a logical consequence of the lower thermal stability of the wax.

2.10.3 Antioxidants

It is very important to investigate the influence of such additives to control both the crosslinking reaction and the resultant physical properties such as thermal resistance, mechanical strength, and dielectric loss tangent of crosslinked polyethylene (XLPE). Most antioxidants reduce the effectiveness of peroxides. According to Mallégol and coworker's report [98], a normal level of poly-2, 2,4-trimethyl-1, 2-di-hydroquinoline diminishes the efficiency of peroxides by approximately 10% and causes a slight discoloration. In the presence of antioxidants such as alkyl substituted phenylenediamines and sterically hindered phenols, cross-

linking is inhibited to a greater or lesser extent, depending on the structure of the peroxide and the antioxidants. Frequently applied antioxidants for crosslinked polyethylene are mentioned by Gugumus in plastic additives handbook [78].

Chariesby [99] reported that the effect of these and other antioxidants may not only reduce the oxygen effect, it may also reduce the degree of crosslinking. Hence, those higher doses of peroxide are needed for the same degree of crosslinking. This could be by the transfer of energy to the antioxidant, or the scavenging of polymer radicals, which might otherwise result in a crosslinked species.

Takanori Tamazaki and Tadao Seguchi [19,100-103] studied the effect of an antioxidant on the reaction mechanisms of chemical crosslinking of polyethylene with dicumyl peroxide at high temperatures by using electron spin resonance (ESR). The effects of antioxidants when added to the PE crosslinking reaction determine free radical behavior. The alkyl radical formation in PE molecules was suppressed by some antioxidants, where the decomposition products of DCP react with the antioxidant. For sulfur and phosphorous type antioxidants, changes of radical species and their contents during the PE crosslinking reaction were observed. It was confirmed that these antioxidants reacted preferentially with radicals yielded by decomposed DCP, restraining the crosslinking of PE by the increased antioxidant content. The compound of DCP and antioxidant decomposed to form 2-phenyl isopropyl radicals, which may initiate PE crosslinking. The ESR technique used in this study can be applied for the selection of an antioxidant in the thermochemical crosslinking process capable of maintaining suitable conditions to optimize the properties of crosslinked polymers.

CHAPTER 3

METHODOLOGY

3.1 Materials

3.1.1 High Density Polyethylene

The blow moulding grades of HDPE used in this study were : Titanex[®] HB 3771 with melt index 0.35 g/10 min, density of 0.954 g/cm³, 1-hexane comonomer - Unipol Technology and HDPE ,Titanzex[®] HB6200 with melt index 0.35 g/10 min, density of 0.956 g/cm³, hexene comonomer -Mitsui Technology. Both HDPE grades were supplied by Titan Polyethylene Malaysia Sdn Bhd. Ethilinas HD5403AA with 0.25 g/10 min, density of 0.954 g/cm³, hexene comonomer –BP gas phase technology was also used in this study.

3.1.2 Additives

The additives that were used in this research are shown in Table 3.1.

Table 3.1: Materials and additives specifications.

Materials Name	Trade Name and Grade	Description	Manufacturer
Organofunctional Silanes	Dynasylan [®] VTMO	Vinyltrimethoxysilane	Degussa-Huls AG
Organofunctional Silanes	Dynasylan [®] VTEO	Vinyltriethoxysilane	Degussa-Huls AG
Dibutyltin Dilaurate (DBTL)	TEGOKAT [®] 218	Hydrolysis/ Condensation Catalyst	TH.Golds Chmidt AG
Dicumyl Peroxide	PERCUMYL D	Crosslinking Peroxide	PT.Nof Mas Chemical Industries
2,5-dimethyl-2, 5-di (tert-butyl peroxy)-hexane	Luperox 101	Crosslinking Peroxide	Atofina Chemical Inc
2,5-dimethyl-2-hydroxy-5-tert-butylperoxy-3-hexyne	Luperox 130	Crosslinking Peroxide	Atofina Chemical Inc
Di-Tert-butyl peroxide	Triganox B	Crosslinking Peroxide	Azo Nobel Polymer Chemical Inc
Pentaerythritol Tetrakis(3-(3,5-di-tert-butyl-4-hydroxyphenyl) Propionate.	Irganox [®] 1010	Phenolic Antioxidant	Ciba Specialty Chemical
(Tris-phenoles) 1,3,5-Trimethyl-2,4,6-tris(3,5-di-t-butyl-4-hydroxybenzyl) benzene	Irganox 1330	Phenolic Antioxidant	Ciba Specialty Chemical
Thiodiethylene bis[3-(3,5-di-tert-butyl-4-hydroxyphenyl)propionate] (Dual functionality).	Irganox 1035	Phenolic Antioxidant	Ciba Specialty Chemical

3.2 Chemical and Blends Formulations

The formulation was based upon typical commercial crosslinkable compound with some modification. The formulation used generally consists of HDPE, organosilanes, initiator and catalyst. The ingredients were used for blending and are called crosslinkable formulation. To determine the composition range that required, the content and concentration of the chemical additives and modifier were varied accordingly with respect to the blend processability and degree of crosslinking. After obtaining the chemicals suitable for the crosslinkable formulation the approximately range or optimum amount of these chemicals were determined so that the formulations are processable on the blow moulding machine.

3.2.1 Selection of HDPE

There types of commercial HDPE were tested for its ability to undergo crosslinking process via siloxan process. Titanex HB 3711, Titanex HB 6200 and Etilinas HD 5403AA of a blow-moulding grade were obtained and its ability verified by gel content and hot set tests.

3.2.2 Selection of Organosilane

Two types of organosilane, that Vinyltrimethoxysilane (VTMO) and Vinyltriethoxysilane (VTEO) were tested for its ability to act as a crosslinking agent. The evaluation is via gel content test and melt flow rate. The effect of organosilanes concentration was also examined. The followings compositions were used for the blends preparation: DCP-0.2 phr DBTL 0.01 phr and organosilane 1.0 to 3.0 phr. A single screw extruder was used, with screw speed of 17 rpm and melt temperature of 175°C, for the sample preparation.

3.2.3 Selection of Radical Initiator

Four type of radical initiator were tested. That Dicumyl Peroxide , 2,5-dimethyl-2, 5-di (tert-butyl peroxy)-hexane, 2,5-dimethyl-2-hydroxy-5-tert-butylperoxy-3-hexyne and Di-Tert-butyl peroxide were tested for their ability to act as a crosslinking agent, This is verified via gel content test and melt flow rate .The effect of organo silanes concentration was also examined. The followings compositions were used for the blends preparation: DCP-0.2 phr, DBTL 0.01 phr and organosilane 1.0 to 3.0 phr.

3.2.4 Selection of Catalyst

Suitable materials for use as the silanol condensation catalyst of this invention include organo-metallic compounds such as dibutyltin dilaurate, stannous acetate, dibutyltin diacetate, dibutyltin dioctoate, lead naphthenate, zinc caprylate, cobalt naphthenate, tetrabutyl titanate, tetranonyl titanate, lead stearate, zinc stearate, cadmium stearate, barium stearate, and calcium stearate. The most preferred catalysts are the organic tin compounds for example, dibutyltin dilaurate [89]. The aforesaid catalyst should be present in a quantity within the range of 0.05 to 0.5 parts by weight per 100 parts by weight of the silane-grafted polyolefin. When a quantity less than 0.005 parts by weight of the catalyst was employed, a lower degree of crosslinking was found in the product, whereas a quantity more than 0.5 parts by weight of the catalyst gave a product having a high surface roughness.

3.2.5 Selection of Antioxidant

The effect of antioxidants were investigated .Three types of primary antioxidants were examined for its performance in inhibiting oxidation, there are

Pentaerythritol Tetrakis (3-(3, 5-di-tert-butyl-4-hydroxyphenyl) Propionate, (Trisphenoles) 1, 3, 5-Trimethyl-2, 4, 6-tris (3, 5-di-t-butyl-4-hydroxybenzyl) benzene and Thiodiethylene bis [3-(3, 5-di-tert-butyl-4-hydroxyphenyl) propionate].

3.3 Mixing Procedures

3.3.1 Preparation of Chemical Liquid Mixture

Vinyltriethoxysilane, dicumyl peroxide and dibutyltin dilaurate (silanol condensation catalyst) were mixed and stirred for 30 minutes at 40 °C in a closed, dry glass flask until a homogeneous liquid mixture was obtained. The mixing parameter for the above chemical mixture was based on physical observation on degree of homogeneity and the solubility with respect to various chemical formulations.

3.3.2 Dry Blend of Compounds

The HDPE, in pellet form, was placed in a dry, sealable cylindrical mixer, filling the mixer to about three-quarters of its capacity. The polymer was injected with a chemical liquid mixture indicated in formulation as shown in Table 3.2 to Table 3.9 by using a syringe. The chemical liquid mixture was added and the mixer was sealed. The PE was dry blended on laboratory scale Fielder mixer (Figure 3.1) for 2 minutes. At the end of this time, chemical mixture had uniformly coated the surface of the polyethylene pellets, but the pellets still appeared wet. The time necessary for complete absorption of the liquid was 2 to 3 hours. After the liquid was completely absorbed in the PE pellets, the polymer was found to be dry. This pellet obtained were then stored in a sealed aluminium-laminated bag to isolate from external moisture.



Figure 3.1: Laboratory scale Fielder mixer

Table 3.4: Selection of type of peroxide (I)

Ingredient	Formulations (phr)														
	S19	S20	S21	S22	S23	S24	S25	S26	S27	S28	S29				
High Density Polyethylene (HB 6200)	100	100	100	100	100	100	100	100	100	100	100				
Vinyltrimethoxysilane (VTMO)	2	2	2	2	2	2	2	2	2	2	2				
Dicumyl Peroxide (DCP)	0	0.05	0.1	0.15	0.2	0.25	0.3	0.35	0.4	0.45	0.5				
2,5-dimethyl-2, 5-di (tert-butyl peroxy)-hexane(L-101)	0	0	0	0	0	0	0	0	0	0	0				
2,5-dimethyl-2-hydroxy-5-tert-butylperoxy-3-hexyne (L-130)	0	0	0	0	0	0	0	0	0	0	0				
Di-Tert-butyl peroxide(L-Di)	0	0	0	0	0	0	0	0	0	0	0				
Dibutyltin Dilaurate (DBTL)	0.01	0.01	0.01	0.01	0.01	0.01	0.01	0.01	0.01	0.01	0.01				

Table 3.5: Selection of type of peroxide(II)

Ingredient	Formulations (phr)														
	S30	S31	S32	S33	S34	S35	S36	S37	S38	S39					
High Density Polyethylene (HB 6200)	100	100	100	100	100	100	100	100	100	100					
Vinyltrimethoxysilane (VTMO)	2	2	2	2	2	2	2	2	2	2					
Dicumyl Peroxide (DCP)	0	0	0	0	0	0	0	0	0	0					
2,5-dimethyl-2, 5-di (tert- butyl peroxy)-hexane(L-101)	0.05	0.1	0.15	0.2	0.25	0.3	0.35	0.4	0.45	0.5					
2,5-dimethyl-2-hydroxy-5- tert-butylperoxy-3-hexyne (L-130)	0	0	0	0	0	0	0	0	0	0					
Di-Tert-butyl peroxide(L-Di)	0	0	0	0	0	0	0	0	0	0					
Dibutyltin Dilaurate (DBTL)	0.01	0.01	0.01	0.01	0.01	0.01	0.01	0.01	0.01	0.01					

Table 3.6: Selection of type of peroxide (III)

Ingredient	Formulations (phr)													
	S40	S41	S42	S43	S44	S45	S46	S47	S48	S49	S50			
High Density Polyethylene (HB 6200)	100	100	100	100	100	100	100	100	100	100	100			
Vinyltrimethoxysilane (VTMO)	2	2	2	2	2	2	2	2	2	2	2			
Dicumyl Peroxide (DCP)	0	0	0	0	0	0	0	0	0	0	0			
2,5-dimethyl-2, 5-di (tert-butyl peroxy)-hexane(L-101)	0	0	0	0	0	0	0	0	0	0	0			
2,5-dimethyl-2-hydroxy-5-tert-butylperoxy-3-hexyne (L-130)	0.05	0.1	0.15	0.2	0.25	0.3	0.35	0.4	0.45	0.50	0			
Di-Tert-butyl peroxide(L-Di)	0	0	0	0	0	0	0	0	0	0	0.2			
Dibutyltin Dilaurate (DBTL)	0.01	0.01	0.01	0.01	0.01	0.01	0.01	0.01	0.01	0.01	0.01			

3.4 Sample Preparation

The blends prepared were extruded through Magic[®] single screw extrusion blow moulding machine as illustrated in Figure 3.2. The operating conditions of the blow-moulding machine are shown in Table 3.10.

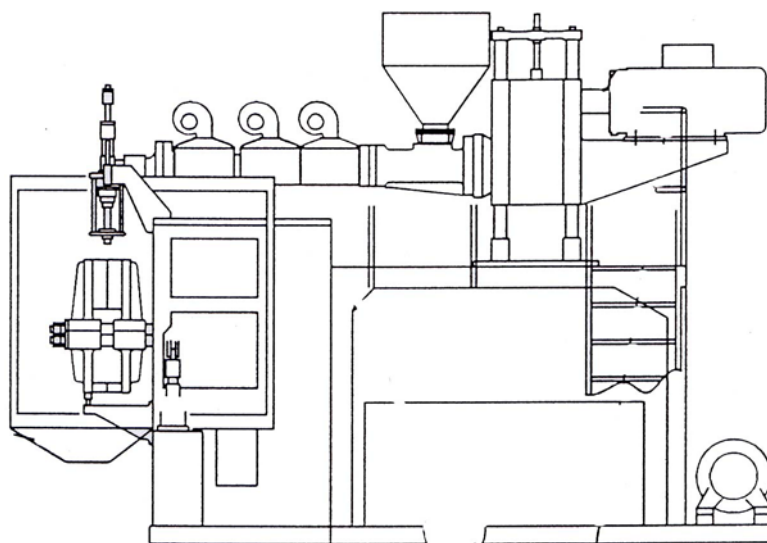

Figure 3.2: A schematic diagram of Magic[®] blow-moulding single screw Extruder

Table 3.10: Operating conditions on blow moulding machine.

Magic [®] Single Screw Extrusion Blow Moulding Machine	
Parameter	Run Conditions
Extrusion Time (Sec)	19.0-25
Screw Speed (rpm)	20-40
Blowing Time (Sec)	12.0
Barrel Temperature (°C)	Zone 1:130, Zone 2:140, Zone 3:150
Adapter Temperature (°C)	Zone 4:150
Die head Temperature (°C)	Zone 5:160, Zone 6:175
Melt Temperature (°C)	150-180
Residence Time (Min)	4-7
Output Of Crosslinkable Polyethylene (kg/h)	75

The standard operating condition of blow moulding machine was fixed after several trial run on with adjusting and manipulating the process with the aim for suite the several of crosslinkable formulation. The process parameter control will affect the reaction mechanism and rate on silane crosslinking HDPE process.

3.4.1 Extrusion Blow Moulding Process

Magic[®] blow moulding single screw extruder consist of a screw diameter of 38 mm, a screw length of 836 mm, a screw L/D of 22:1, a feed-transport zone length of 8D (304 mm), compression-metering zone length of 6D (228 mm), a metering-pumping zone length of 8D (304 mm), a channel depth in the feed-transport zone of 6.3 mm, a channel depth in the metering-pumping zone of 2.1 mm, a nominal compression ratio (depth ratio) of 3:1, and a 7.5 horsepower, variable speed AC motor. The extruder barrel was divided into three zones with 3 temperature controllers, operating electrical resistance heating and proportional cooling for each of the three zones. Dry blended HDPE compounds were introduced into the hopper

of the Magic[®] blow moulding machine to extrude a 450ml bottle as shown in Figure 3.3.



Figure 3.3: A schematic diagram of an extruded bottle

The extrusion blow moulding process consists of four stages [104,105]: Stage one is melting of the resin in the extruder and formation of the parison, stage two is positioning the parison in the mold and then at stage three is inflation of the parison to the contours of the mold; and final stage is ejection of the piece from the mold, as shown in Figure 3.4.

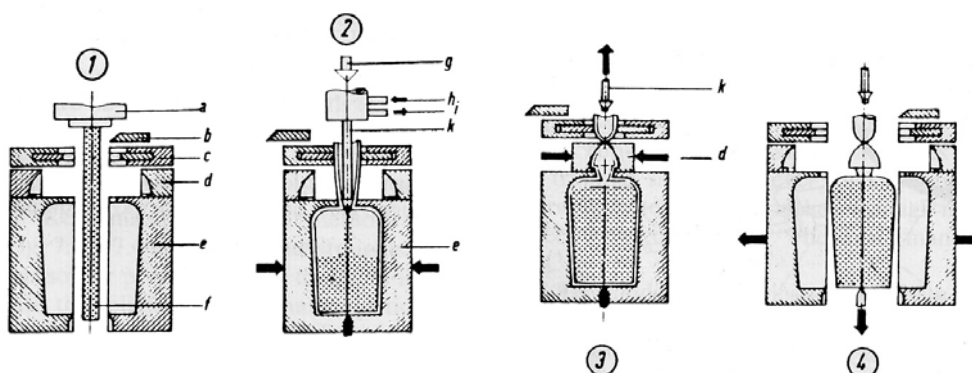

Figure 3.4: Extrusion blow moulding process

3.4.2 Curing

Bottle obtained after moulding were not fully cured. The curing process was accomplished by immersing the bottle in hot water for 4 hours at 90 °C. Four hours were found to be a suitable curing time to achieve maximum crosslink.

3.5 Characterization and Testing

Table 3.11 lists the common test techniques used in this study to characterize crosslinked polyethylene according to standard specification for crosslinkable ethylene plastics-ASTM D2647 [106] and standard specification for polyethylene plastics moulding and extrusion materials-ASTM D1248 [52].

Table 3.11: Summary of the crosslinkable compound characterization tests.

Test Item	Test Method
Physical Test	
Density	ASTM D1505
Rheological Testing	
Melt Flow Rate	ASTM D1238
Mechanical Testing	
Tensile Strength at Break	ASTM D638
Elongation at Break	ASTM D638
Aged Tensile Strength at Break	ASTM D638
Aged Elongation at Break	ASTM D638
Hot Set Test (Elongation/Set)	IEC 811-2-1
Chemical Analysis	
Gel Content	ASTM D2765
Fourier Transform Infrared Analysis	ASTM D1421
Methanol Wash	Industrial Standard
Thermal Analysis	
Differential Scanning Calorimetry	ASTM D3417
Thermo gravimetric Analysis	ASTM D3850

3.5.1 Density Test

The crystallinity of a polymer is directly related to its density. For a homogeneous polymer. Density of crosslinked and non-crosslinked HDPE was measured by ASTM D1505-1998 [127] “Density of Plastics by the Density-Gradient Technique” using a Techne® density gradient column, model DC-4 as shown in Figure 3.5. This test method was designed to yield results which are accurate to better than 0.05%. In addition, the required size of the specimen very small. A one-meter long glass gradient tube filled with solution consisting of a mixture of isopropanol and water mixture at 23 °C in the density a range of no more than 0.02 g/cm³. For crosslinked HDPE, it would typically be 0.930 g/cm³ at the top, to 0.960 g/cm³ at the bottom. A minimum of five glasses floats covering the desired density range is evenly distributed through the tube. Their position was plotted against density so that a calibration curve obtained. A test specimen with a size not less than 0.127 mm³ was gently placed in the tube and its equilibrium position was noted. The density of the specimen then be deduced using the calibration curve.

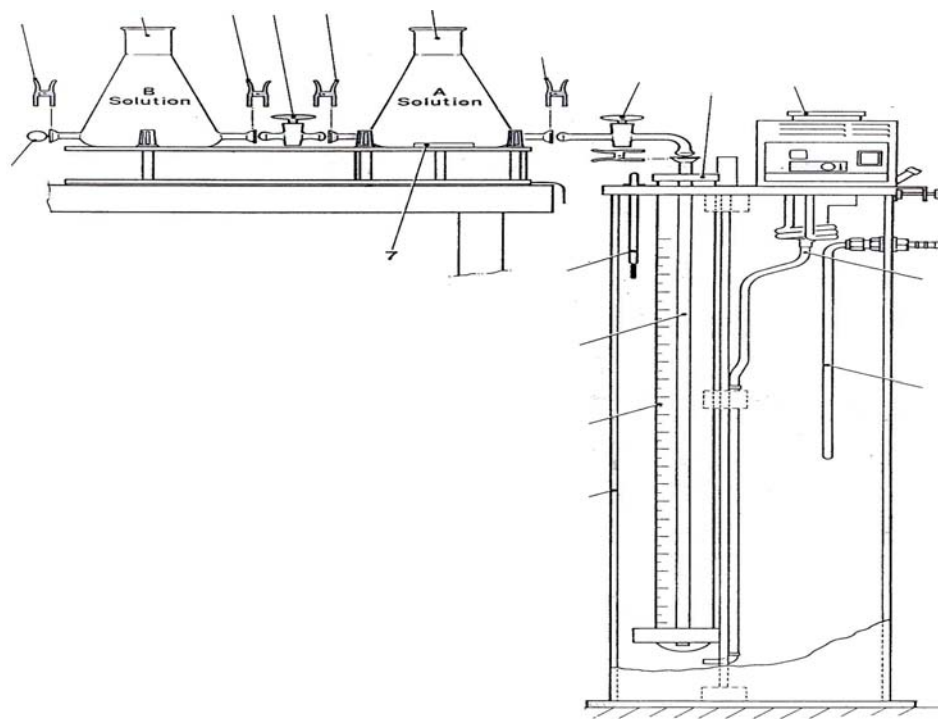

Figure 3.5: A schematic diagram of Techne® density gradient column, model DC-4

3.5.2 Melt Flow Rate

The crosslinked and non-crosslinked HDPE polymer melt viscosity were measured by a ZWICK 4105 melt flow indexer (Figure 3.6) in accordance with ASTM D1238 procedures. An applied load of 2.16 kg load was used at a barrel temperature of 190 °C with a die internal diameter of 2.095 mm [107]. The material to be tested placed in a heated barrel (190 °C) and a piston mounted in the barrel so that there a dead weight loading on the molten material which forces it through a die of specific length and diameter. The amount of material extruded through the die in ten minutes, measured in grammes, is defined as the melt flow rate or MFR. There is a relationship between the MFR and the average molecular weight of polyethylene.

The lower the MFR the higher is the average molecular weight and conversely the higher the MFR the lower is the average molecular weight. The melt flow rate of polymers is dependent on the rate of shear. The shear rates in this test much smaller than those used under normal conditions of fabrication. Therefore, data obtained by this method may not always correlate with their behaviors in actual use.

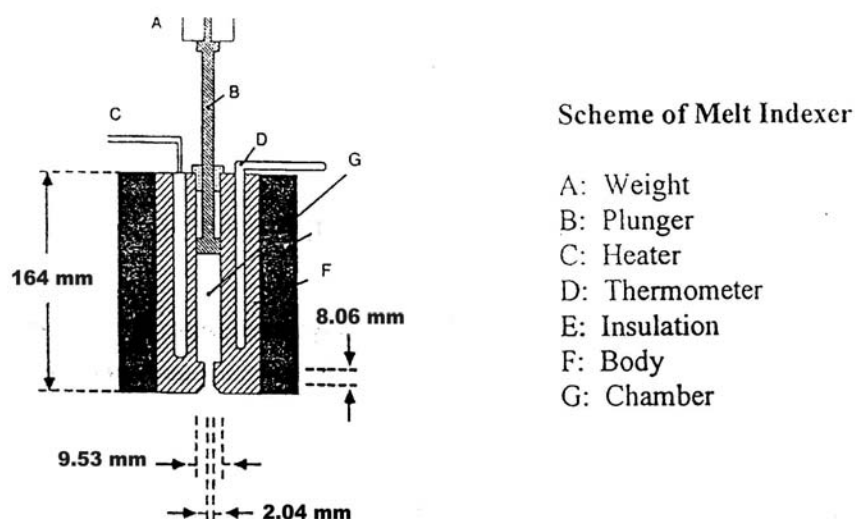
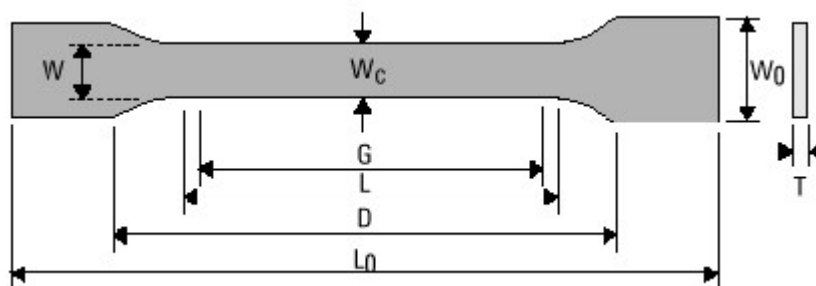

Figure 3.6: A schematic diagram of melt flow indexer.

3.5.3 Tensile Test

Measurements of the mechanical properties such as tensile strength and elongation at break, were performed according to the ASTM D638-97[108] method and using the Type IV specimen geometry as shown in Figure 3.7 on an Instron mechanical tester, Model 5567 (Figure 3.8).

The samples have gauge length, width, and thickness equal to 25, 6.0 and 2.0 mm respectively. Measurements were done using a 5 mm/min crosshead speed at room temperature and 50 % humidity. A clip on extensometer with a gauge length of 25 mm was used to measure the specimen elongation [108]. Test specimens were kept at 23 °C and 50 % humidity for 48 hours before the test [109]. Five measurements were conducted for each sample and average results were calculated to obtain a mean value.



	Dimension	Type IV
W	Width of narrow	6 mm
L	Length of narrow section	33 mm
W ₀	Width overall, min	19 mm
L ₀	Length overall, in	115 mm
G	Gage Length	25 mm
D	Distance between grips	14 mm

Figure 3.7: Specimen dimension for tensile testing (ASTM D638M Type IV)



Figure 3.8: Instron universal tensile machine model 5567

3.5.4 Accelerated Thermal Aging Test

ASTM D 5510-94 [110] and ASTM D3045 [111] describe the standard test method for the deterioration of plastics in an air oven due to the combine effects of oxidative and thermal aging. The basic principle of the test is to expose crosslinked and non crosslinked test pieces to air at an elevated temperature for specified periods of time. After aging, their physical properties were determined and compared to properties determined on the original test pieces. Properties for both before and after aging were measured at room temperature. Thermal aging represents an important stress, which can affect greatly the properties of the polymer and may produce a limit to the effective service life of crosslinked product by thermal breakdown mechanisms.

Thermal aging of samples was performed at 135 °C and 150°C in an air flow rate of 2100 cm³/h for 168 hours using a heat aging oven from Ceast, Type 1175,

U.K as shown in Figure 3.9. These temperatures are accepted by wire and cable industries for characterizing high-temperature products [112].



Figure 3.9: Ceast heat aging oven type 1175

3.5.5 Hot Set Testing

This is a test to determine the crosslinking density of polyethylene sample. It is the standard method to measure whether a sample has sufficient mechanical properties at elevated temperature. It measures the amount of elongation (%) of a crosslinked sample under a constant load at a temperature of 200 °C. The higher the elongation the lower is the crosslinking density.

The hot set test is a practical method, allowing a direct estimation of the heat deformation resistance of the material. A dumb-bell shaped test pieces were cut from the cross linked strips of molded bottle in accordance to IEC 811-1989 [112]. The dumb-bell test pieces had an overall length of 75 mm, a width of ends of 12.5 ± 1 mm, a length of narrow parallel portion of 25 ± 1 mm, a width of narrow parallel

portion of 4.0 ± 0.1 mm, a small radius of 8 ± 0.5 mm, and a large radius of 12.5 ± 1 mm as shown in Figure 3.10. The dumb-bell specimens were then subjected to a hot deformation test pursuant to IEC 811-1989 to determine the maximum extension under load and permanent extension of the sample. In the hot set test, each test piece was suspended at one end by a grip in an oven and a lower grip was attached to the lower end of each test piece for the purpose of suspending weights as shown in Figure 3.11. In operating the test, a load of $20\text{N}/\text{cm}^2$ (N being a Newton) was applied to the test piece for 15 minutes while suspended in the oven at a temperature of 200°C . The test pieces were initially formed with spaced marker lines extending in parallel, transversely across the narrow parallel portion or neck. The initial, pretest distance separating the marker lines was 20 mm before exposure to load and elevated temperature. After 15 minutes under the load of $20\text{N}/\text{cm}^2$ at 200°C , the distance between the marker lines was measured and the increase in distance over the initial pretest distance was divided by the initial pretest distance and multiplied by 100 to give the percent extension at 200°C , which was reported as "Extension in percent at 200°C ". A lower percent extension at 200°C indicates a higher degree of cross-linking and a greater percent extension indicates a lower degree of crosslinking.

After measuring the distance between the marker lines while the specimen was under the load of $20\text{N}/\text{cm}^2$ at 200°C , the load was then removed and the test pieces were allowed to recover for 5 minutes at 200°C . Then the sample were removed from the oven and allowed to cool slowly at ambient temperature after which the distance between the marker lines was measured.

The distance of permanent extension was then divided by the initial distance between the marker lines and multiplied by 100 to give the percent permanent extension, and was reported as such in the tables. The lower the percentage of permanent extension generally indicates a higher level of cross-linking. To fulfill the crosslinking polymer specification, the maximum elongation tolerable is 175% and the maximum permanent elongation tolerable is 15% according to IEC 811 standard.

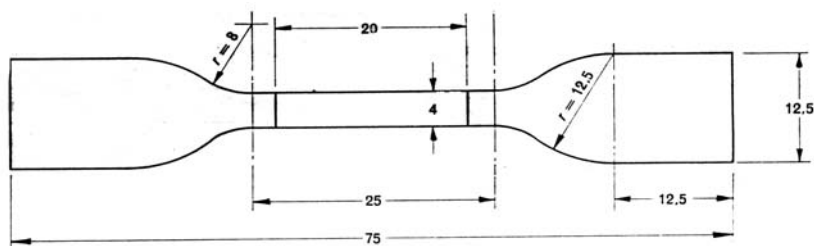

Figure 3.10: Specimen dimension for hot set test (IEC 540-85)

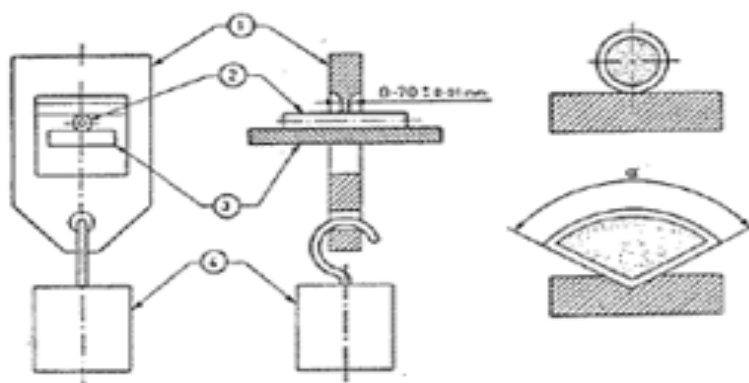

Figure 3.11: A schematic diagram of hot set testing

3.5.6 Degree of Crosslinking -Gel Content Test

Degree of crosslinking of the silane crosslinked sample was measured by determining their gel content after crosslinking reactions. The determination of the gel content was performed by extracting the soluble component with decahyronaphthalene with refluxing at 200°C for 6 hours according to ASTM D 2765-1995 Method B [62].

In this test, shavings of the extrudate were taken, weighted and placed into a 1000 ml of decahyronaphthalene [113] which was boiled for 6 hours (Figure 3.12). The portion of un-dissolved HDPE was dried at 150°C for 1 hour, weighted and

compared with the original weight. The results reported here were the averages of three samples.

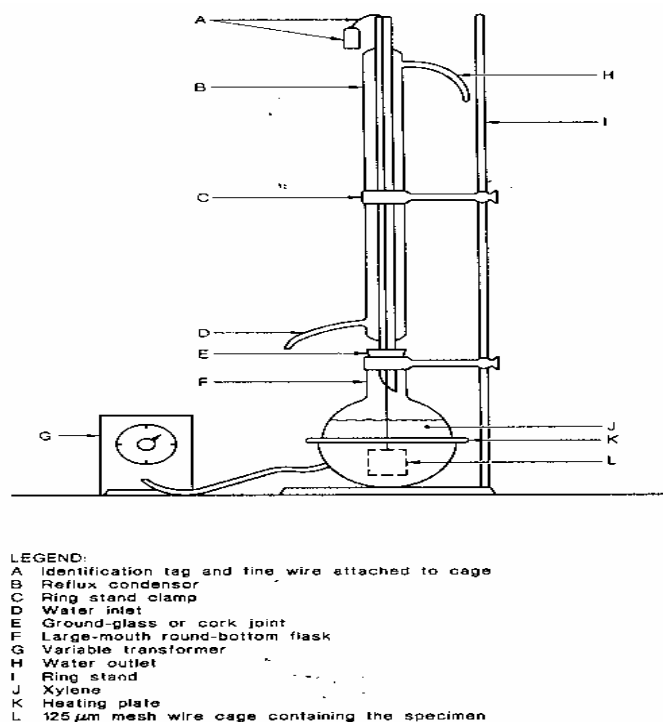

Figure 3.12: Gel content testing apparatus

3.5.7 Fourier Transform Infrared (FTIR) Spectroscopy Analysis

Fourier Transform Infrared (FTIR) Spectroscopy was used to qualitatively demonstrate the grafting reactions of the silane onto sample. Secondly, quantitatively identify the specific functional groups in the sample, and determine the concentration of such groups [7, 8, and 21,114-118].

Silanes grafting reactions of HDPE sample were characterized by using Perkin Elmer Spectrum 2000 Explorer FT-IR Spectrometer. Figure 3.13 at a constant spectral resolution of $R=2.0\text{ cm}^{-1}$, in the range of $4000\text{-}400\text{ cm}^{-1}$, after acquiring 50 scans. Quantitative spectral differences, resulting from small differences in the

thickness of individual samples and in their radiation dispersions (turbidity) were mathematically corrected, based on the spectrum of the pure, starting polyethylene as a thickness and turbidity standard. After subjecting the basic spectra to mathematical correction, analytical FTIR spectra were obtained by subtracting the spectra of the 0.71-0.72 μm thick pure polyethylene samples from the corrected ones. The spectra of the samples investigated were shown in three frequency ranges, to enable observation of the changes taking place in hydroxy, carbonyl and silicon groups. The bands chosen for the analysis were in the regions of $650\text{-}1550\text{ cm}^{-1}$.



Figure 3.13: Perkin Elmer Spectrum 2000 Explorer FT-IR Spectrometer

3.5.8 Differential Scanning Calorimeter (DSC) Measurements

Pure and crosslinked HDPE were analysed in a Differential Scanning Calorimeter Analyses (Perkin Elmer, DSC 7) as shown in Figure 3.14. Calorimetric measurements were carried out as cooling- heating and heating-cooling sequences under N_2 atmosphere. The melting points T_{m1} and T_{m2} (T_{m1} ; first run melting temperature, T_{m2} ; second run melting temperature), crystallisation (T_c); crystallisation temperature during cooling after first run melting and crystallisation (T_{c2})

temperatures, and enthalpy change of both heating (ΔH_f) and cooling (ΔH_c) curves were examined.

The samples used for DSC measurements were 10 to 12 mg, encapsulated in aluminium pans at a heating, cooling. The samples were heated under nitrogen in DSC at a rate of 10 °C/min from 30 to 200°C, followed by cooling at 10°C/min to 30 °C (quenched to remove any previous thermal history), and then heating again at 10 °C/min to 200°C to obtain the first cooling exotherms and the second set of heating endotherms in which several peaks were obtained for each sample. Integration of the endothermic peak area was performed with the software supplied by Perkin Elmer Instruments [9-12, 23,119-121]. The type of baseline of connecting the start and the end of the endothermic peak was the sigmoidal line, with horizontals at the start and the end of the peak. ASTM D3417-99 [122] and ASTM E 794-98 [123] were used as standard procedures to analyse the thermal properties of the sample.



Figure 3.14: Perkin Elmer Differential Scanning Calorimeter Analyses

3.5.9 Thermo gravimetric Analysis (TGA) Measurements

Perkin Elmer Thermogravimetric Analyser TGA 7 (Figure 3.15) was used to analyse the thermal stability of samples in terms of the decomposition temperatures of the sample. The samples for TGA measurements were 10 to 12mg heated from room temperature to 800°C at a heating rate of $10\text{ }^{\circ}\text{C min}^{-1}$ under nitrogen atmosphere. Loss of the polyethylene content and the thermal stability of the compound can be estimated accordance to ASTM D3850-2000 [124]. Also TGA used to determine the composition of additives and filler content accordance to ASTM D6370-1999 [125].

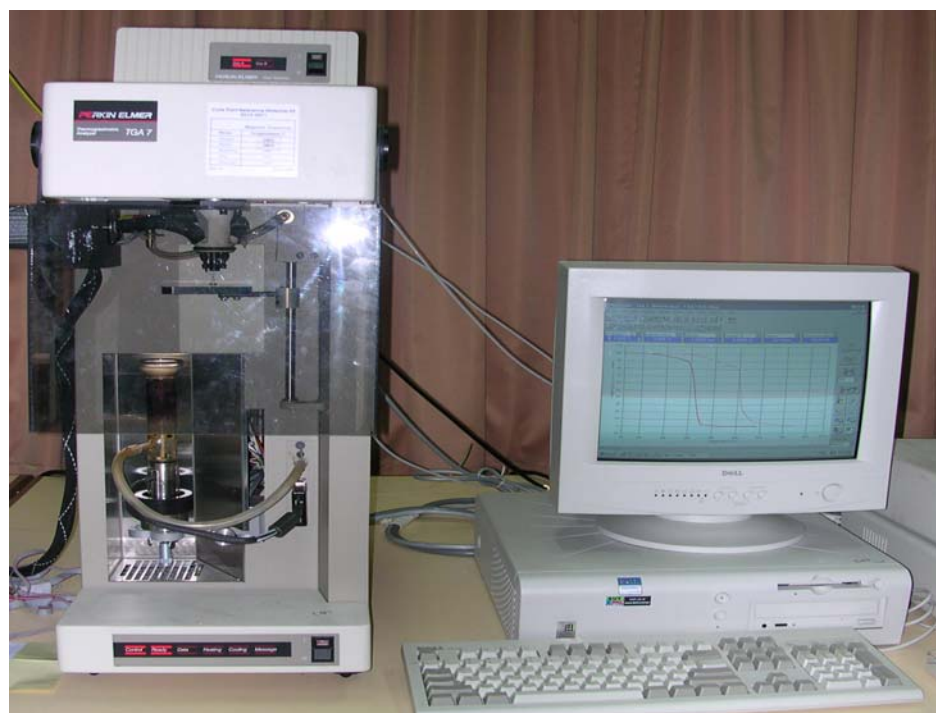

Figure 3.15: Perkin Elmer Thermogravimetric Analyser TGA 7

3.5.10 Methanol Wash Test

This method describes the procedures used for determination of the total amount of fines and additives on the surface of silane crosslinkable pellets. The

washing followed by the procedure starts by: Weighing a minimum amount approximately 50 ± 0.1 g samples of pellets in a beaker followed by the additional of 100 ml of methanol and stirred for 5 minutes. Then, the solution was filtered through a buchner funnel with prescribed filter.

The determination of mechanical fines content was done by drying the screen in a heating chamber at $90\text{ }^{\circ}\text{C}$ for 5 minutes. Then, the dried filter was weighed to the nearest 0.0001 g to determine the content of mechanical fines.

The determinations of fine additives content were done by evaporating the methanol in a water bath at $80\text{ }^{\circ}\text{C}$. When the entire methanol has been evaporated, the dish was then transferred to a vacuum cabinet and the remaining methanol was evaporated under vacuum ($< 10\text{ kPa}$) at $60\text{ }^{\circ}\text{C}$ for during 15 minutes. The dish samples were put in desiccators to cool to room temperature. The dried and cooled dishes were then weighed to the nearest 0.0001 g to determine the total content of additives. The total content of fines and additives was reported as ppm of the total weight of pellets.

3.5.11 Oxidative Induction Time (OIT) Measurements

OIT measurement by differential scanning calorimeter (DSC) was described in ASTM D 3895-95 [167]. A Perkin-Elmer DSC 7 was used. The OIT value was determined using open Al pan. 10 ± 1 mg of the sample was heated from ambient to $200\text{ }^{\circ}\text{C}$, at $10\text{ }^{\circ}\text{C}/\text{min}$ rate under N_2 . At that point temperature was allowed to equilibrate and then heating continued isothermally at $200\text{ }^{\circ}\text{C}$. After the temperature stabilization the purge gas was switched from N_2 to O_2 . The exact point of gas switch is recorded on the thermogram as a disturbance of the weight curve. The time interval between the O_2 insertion (disturbance) and oxidation onset point was measured within ± 0.1 min and is the Oxidative Induction Time (OIT).

CHAPTER 4

RESULTS AND DISCUSSION

4.1 Selection of HDPE Type

The siloxan-process uses HDPE with melt index ranging from 0.25 to 0.35 g/10 min at temperature 190°C and weight of 2.16kg. HDPE in range of viscosity range can be crosslinked by the siloxan process without problems provided that a proper selection of reactants (quantitative and qualitative) and the optimum production parameters are chosen. It can be taken from the data in Table 4.1 that a lower melt flow index (higher molecular weight) of the HDPE gives better crosslinking results as determined by the hot set test. But in this project, Titanzex HB 6200 was chosen as HDPE as research material because of processability and new generation of technology-Bimodal Technology.

Table 4.1: Type of HDPE used in the research

Type of Commercial HDPE	Density	MFI	Average Gel Content	Average Hot Set
Units	g/cm ³	g/10 min	%	%
Titanex HB 3711	0.954	0.35	70	65
Titanzex HB 6200	0.956	0.35	70	65
Etilinas HD 5403AA	0.954	0.25	75	50

4.2 Selection of Organo Silanes

4.2.1 Effects Crosslinker Type and Concentration

Figure 4.1 shows the effect of organo silanes type and concentration on the gel percentages of crosslinked HDPE (Titanzex HB6200). With increasing organosilanes concentration, the gel percentages of vinyltrimethoxysilane (VTMO) crosslinked HDPE increased rapidly from 24.5% to about 65 % at low crosslinker concentrations (1 to 1.8 phr), and the gel percentage increased slowly at high crosslinker concentrations. In the case of vinyltriethoxysilane (VTEO) as crosslinker, no gel was obtained at low crosslinker concentrations (1 phr); at crosslinker concentrations higher than 1.2 phr, slow increment in the gel percentages were observed with increasing VTEO concentration. These indicate a much greater grafting and crosslinking efficiency of VTMO than of VTEO, which is probably the result of large steric hindrance in the case of VTEO since the reactive sites are close to the bulky triethoxysilane/ alkoxy silane groups.

The influence of organo silanes type and concentration on the melt flow rates of grafted HDPE is shown in Figure 4.2. With increasing crosslinker concentration, similar trends of decreasing melt flow rates were observed for both VTMO and VTEO grafted HDPE. However, the melt flow rates of VTMO grafted HDPE were at much lower levels than those of VTEO-grafted HDPE, indicating that more pre grafting or cross linking of HDPE occurred during grafting with VTMO. This again could be a result of large steric hindrance in VTEO grafted HDPE macro radicals, which inhibits the termination of macro radicals by combination by chemistry theory. In addition, stabilization of VTMO grafted HDPE macro radicals by conjugation could increase the possibility of termination by combination. At crosslinker concentrations higher than 1 phr, the melt flow rates of silane grafted HDPE were even smaller than that of pure HDPE (0.35 g/10 min), indicating that some grafting and crosslinking of HDPE occurred during processing. This may be due to the increased in the amount of termination by combination at high organo silane concentrations.

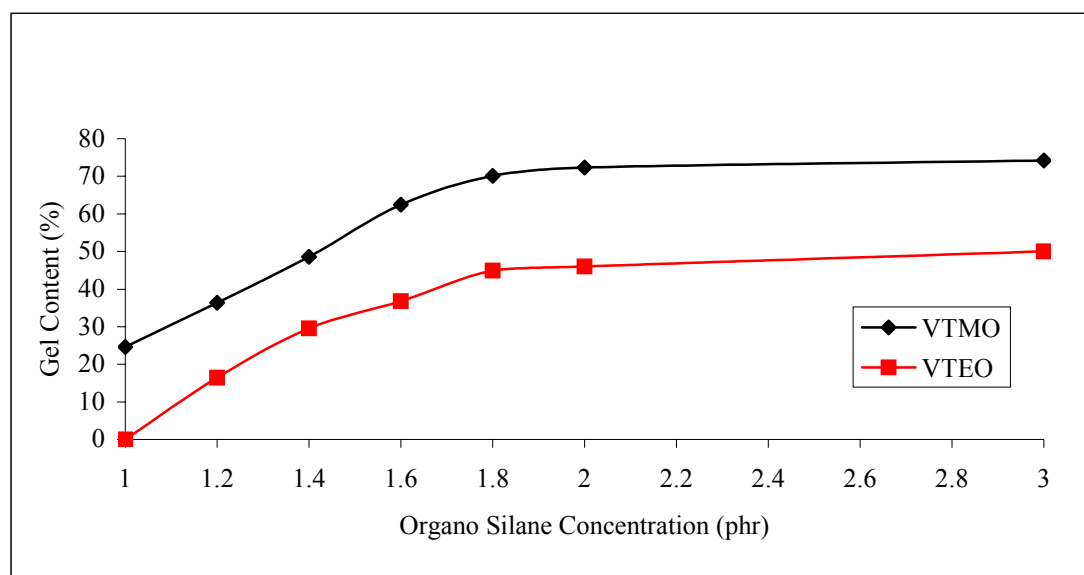

Figure 4.1: Effect of type and concentration of crosslinker on gel percentage at DCP : 0.2 phr, DBTL: 0.01 phr. (The single screw extruder was operated at 17 rpm and melt temperature 175 °C).

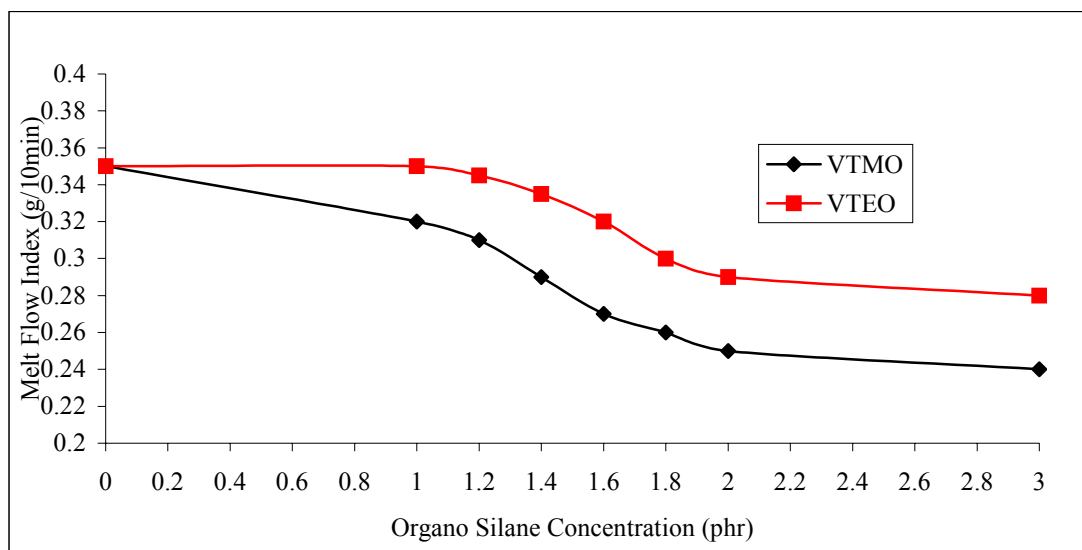

Figure 4.2: Effect of type and concentration of crosslinker on melt flow index, DCP: 0. 2-phr, DBTL: 0. 01 phr.

In testing for the organo silanes, the crosslinking efficiency of alkoxy silanes (when compared in equimolecular quantities in otherwise uncharged formulations) decreased with increasing molecular weight (order of effectiveness: vinyltrimethoxy > vinyltriethoxy). This is perhaps due to steric hindrance of the larger molecular coupling agents in the grafting process. The concentration of vinyltrimethoxysilane relating to 100 parts of base polymer should be between 1.0 to 3.0 phr. Lower concentration reduced the safety margin with respect to the requirements of the hot set property. A dosage of over 2 parts did not significantly improve the crosslinking results. Effects of the type and amount of crosslinker on the gel content of cross-linked HDPE and degradation of HDPE during grafting were remarkable. The gel content of VTMO grafted HDPE were much higher than those of VTEO grafted HDPE, while less scorching of HDPE during grafting was observed for VTMO grafted HDPE.

4.3 Selection of Radical Initiator Type

The most suitable method of producing the necessary radical sites on polyethylene macromolecules required for the siloxan process is by thermolytic decomposition of peroxides. The type of peroxide and its concentration is the most effective chemical way of adapting the siloxan process to existing processing reactor. Problems arising in the initial production phase on new machinery or resulting from changes in base polymers have the best chance to be corrected by solely changing the concentration or type of the radical initiator.

The peroxides used in the siloxan process are quite limited. The reasons for this are found in the requirements of processing. The peroxides must have a certain thermal stability in order to allow its dispersion along with the other components in the base polymer without decomposing. Mixing temperatures of the mixing reactor in this mixing phase are 30 to 50°C, high enough to ensure proper absorption but otherwise so low as to cause only little decomposition of peroxide and hence pre-crosslinking of the polyethylene or grafted polyethylene. Use of peroxides with low decomposition temperatures would result in premature reaction, which in turn leads to extrudates with rough surface and reduced crosslinking. After the dispersion of all components of the crosslinking system in the polymer, the grafting reaction takes place in the extruder with the principal requirements listed as (a) appropriate temperature for processing HDPE with respect to melt viscosity, orientation and output, (b) the superimposed process of grafting the silane. Peroxides with higher decomposition temperatures could also be used, but they require higher reaction temperature, longer residence time and or increased concentrations. Table 4.2 summarizes the characteristics of peroxide initiators used during the selection.

Table 4.2: Characteristics of peroxide initiators [87].

HDPE and Type of Peroxide	Abbreviated Marking	Solubility Parameter	Active oxygen	Molecular Weight
Units	-	δ (J cm ⁻³) ^{0.5}	(%)	(MW)
HB 6200	HDPE	16.8	-	-
Dicumyl peroxide	DCP	17.4	5.80	270
2,5-dimethyl-2, 5-di (tert-butyl peroxy)-hexane	L-101	15.5	10.03-10.25	290
2,5-dimethyl-2-hydroxy-5-tert-butylperoxy-3-hexane	L-130	19.1	10.05-10.61	286
Di-Tert-butyl peroxide	L-DI	15.3	10.8	146

The effect of the peroxide initiator nature on the grafting of vinyltrimethoxysilane (VTMO) onto high-density polyethylene (HDPE) was investigated in the course of the reactive extrusion. The solubility of the peroxide initiator in the molten polymer is most important in the silane grafting onto HDPE. The thermal stability of peroxide initiator is also important. At the synthesis conditions (melt temperature 150°C to 180 °C) of preparing the grafted products by the reactive extrusion, peroxides, which decompose at temperatures far above the silane melting point (also in the feed zone of the extruder), can be used to initiate grafting reactions. It is very probable that radicals formed from peroxide decomposition interact first with HDPE macromolecules, while the formed macro radicals initiating silane-grafting reactions. Peroxides, which are easily dissolved in HDPE, are recommended for initiating the efficient grafting reactions. The closer the thermodynamic affinity between the peroxide and the polymer, the less the efficiency of grafting. Higher transportation velocities of the reactive blend in the extruder-reactor intensify HDPE crosslinking, thus lowering the silane grafting efficiency. This work analyses the role of organic peroxide initiators in VTMO and HDPE grafting reactions.

4.3.1 Effect of Peroxide Initiator Type and Concentration

Peroxides L-101 and L-DI, having the solubility parameter (δ) similar or closer to the HDPE polymer (Table 4.2). this in fact implies a high solubility of this peroxide in the molten polymer. As it is reported by Coleman and coworkers [128], substances are thermodynamically miscible in the absence of strong specific interactions between them, if their solubility parameter (δ) values differ by less than $2 (\text{J cm}^{-3})^{0.5}$. The peroxide L-130 solubility parameter is much higher than that of HDPE. Besides, it contains a hydroxyl group, and this fact should provide for a better thermodynamic affinity between L-130 and the HDPE [128].

The analysis of derivatograph findings, Table 4.3 shows significant differences in the thermal stability of the peroxides used here. It should be noted that more accurate data were obtained for solid peroxides, e.g. DCP, for which there was a good coincidence in the temperatures at the beginning of decomposition and the maximum decomposition rate, as indicated by DTG and DTA curves as studied by Pesetskii and coworkers [85].

For liquid peroxides 2, 5-dimethyl-2, 5-di (tert-butylperoxy)-hexane (L-101), it was observed that some shifting in maxima on DTG and DTA curves towards the high-temperature region, associated, probably, with their volatility. It was rather difficult to obtain reliable data on thermal decomposition of di-tert-butyl peroxide (L-DI), because it was highly volatile during heating.

Dicumyl peroxide (DCP) exhibited the highest thermal stability. They started to decompose with noticeable rates and distinct exothermal effects at 130–133°C. The least stable were anticipated to be di-tert-butyl peroxide (L-DI). The half-life time ($\tau_{0.5}$) for DCP and L-101 in a hydrocarbon environment at 160 and 180°C, as listed in Table 4.3, correlate with the derivatograph findings.

Researches could not determine the half-life time for the peroxides in the moving HDPE melt under shearing conditions. However, as base on experiments were run on the extruder with the main reaction temperature at 175°C, it was obvious that peroxides DCP and L-101 could completely decompose.

Figures 4.3 and 4.4 show concentration dependencies of the grafting efficiencies and the MFI for silane crosslinkable polyethylene prepared in the presence of peroxides DCP, L-101 and L-130. In order to compare the performance of peroxide at the same half-life time of about 1 min, the processing temperature was set to 130°C when DCP was used as initiator, the processing temperature finally increased to about 175°C as a result of shearing and viscous dissipation. In the ranges studied, L-101 resulted in higher gel percentages than DCP at a fixed initiator concentration.

Table 4.3: Derivatograph data on thermal stability of peroxides and their half-life time in hydrocarbon environment. [85].

Peroxide	DTG			TG Weight Loss (%)	DTA			Decomposition parameters for peroxide in hydrocarbon environment	
	Type	Beginning of decomposition peak (°C)	Completion (°C)		Maximum (°C)	Melting Point (°C)	Beginning	Maximum	T (°C)
Dicumyl Peroxide (DCP)	131	202	162	74.5	43	131	162	160	4-7
2,5-dimethyl-2, 5-di (tert-butylperoxy)- hexane (L-101)	118	176	155	94.0	-	123	162	180	0.9
Di-Tert-butyl peroxide (L-Di)	15	125	103	96.0	-	30	98	160	6-8
2,5-dimethyl-2- hydroxy-5-tert-butyl peroxy-3-hexyne	130	200	170	88.0	-	133	172	180	2.3

Data in Tables 4.2 and 4.3 imply that peroxides L-101 (in liquid form) easily dissolve in HDPE. However, their thermal stability different considerably, Table.4.3.peroxide L-101 quickly decomposed at a relatively low temperature (exothermal peak began at 118°C for L-101, while DCP began at 131°C). Thermal stability differed insignificantly for L-101 and L-130 in term of solubility parameters.

Figures 4.3 and 4.4 show an identical mode of the concentration dependencies on the grafting efficiency and the MFI for DCP, L-101 and L-130. Peroxide L-101 easily initiated grafting of VTMO onto HDPE over the whole concentration range, efficiency of grafting changes from 50 to 80% for L-101 concentrations varied between 0.1 and 0.3 phr. At concentrations over 0.1 phr, however, it was observed that HDPE was crosslinked, which was accompanied by a significant decrease in the MFI: from 0.29g/10 min at 0.1 phr concentration up to 0.15 g/10 min at 0.3 phr concentration for peroxide L-101. When DCP was used, grafting became more intensive at higher peroxide concentrations, and reached 50–80% at 0.15–0.40 phr concentrations. In contrast to L101, for the case of DCP, the melt flow rate of VTMO grafted HDPE decreased with increasing DCP concentrations, indicating that pre grafting of HDPE occur during the grafting process. This is probably due to the combination process in the case of DCP as an initiator instead of disproportionation, which is in agreement with the report conducted by Ho-Gab Jeong [129] and Yu [130].

The gel percentage of crosslinked HDPE with DCP and L-130 as an initiator showed similar increasing trend as that with L-101. Nevertheless, L-130 resulted in slightly lower gel percentages than those of DCP at a fixed initiator concentration. Secondly, the different nature (solubility parameter and volatility) of L-101, L-130 and DCP may also be a reason for such behavior; L-101 and L-130 radicals have a larger tendency of termination by combination with HDPE macro radicals than DCP radicals as a result of smaller steric hindrance, reducing the possibility of HDPE macro radicals to be terminated by disproportionation.

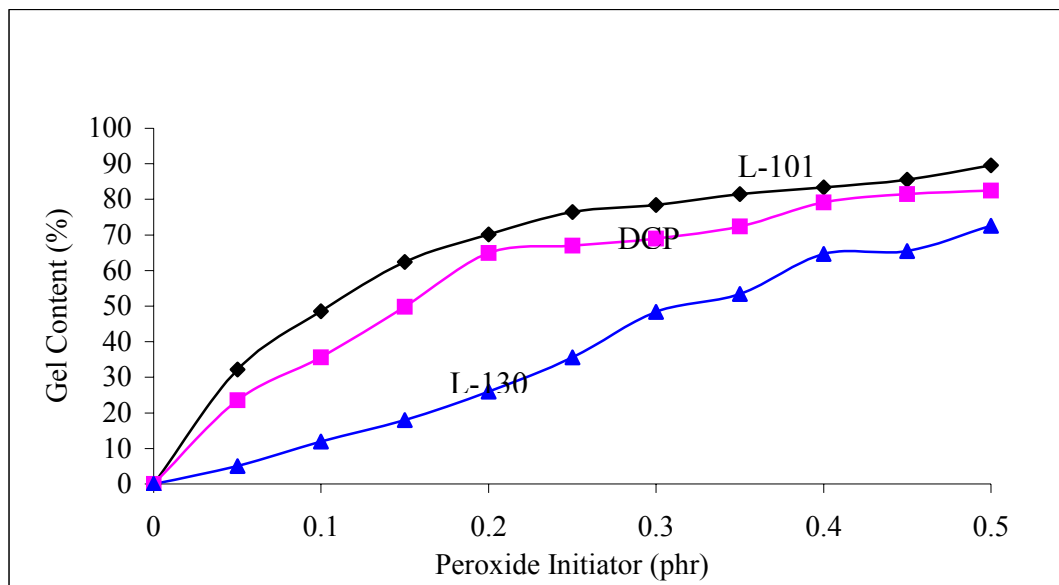

Figure 4.3: Effect of various peroxide concentrations on gel content at VTMO: 2.0 phr, DBTL: 0.01 phr. (The single-screw extruder was operated at 17 rpm and melt temperature 175 °C)

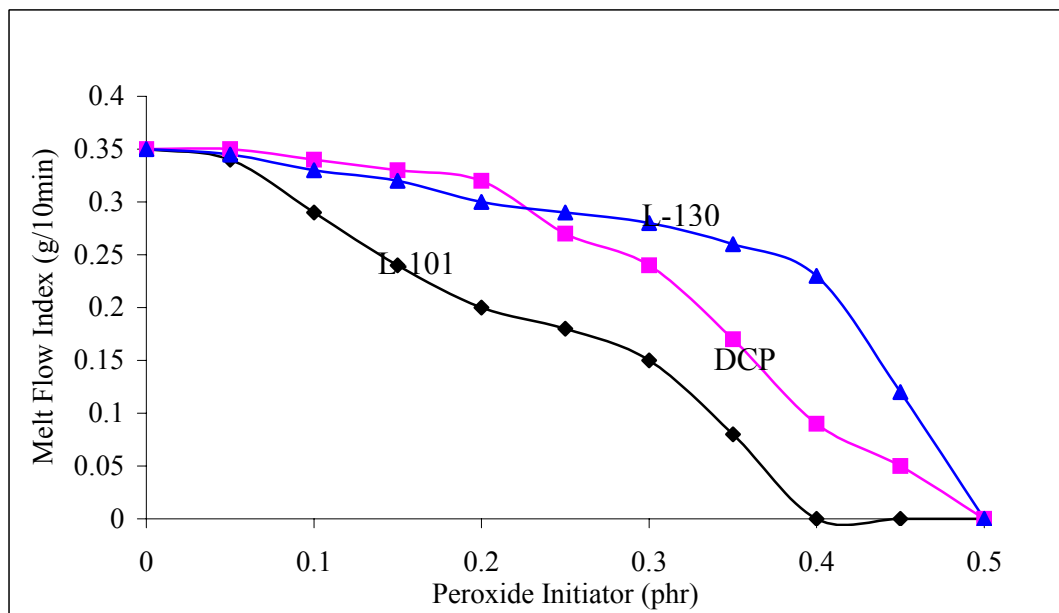

Figure 4.4: Effect of various peroxide concentrations on melt flow index of grafted HDPE at VTMO: 2.0 phr, DBTL: 0.01 phr.

The differences in the effectiveness to initiate the free-radical grafting reactions of VTMO and HDPE crosslinkable system by peroxides L-101 and DCP, which are easily dissolved in HDPE, can, probably, be explained by a lower thermal stability of L-101.

The experimental conditions provide a temperature of 130°C in the feed zone of the extruder-reactor. Within this zone, L-101 dissolved in the molten HDPE and fully decomposed to radicals. As the VTMO boiling point is 123°C, any interactions of radical decay products are hardly possible. Therefore, radicals attack polyethylene macromolecules. The macro radicals thus formed begin to react with silane to give grafted products; they also recombine between themselves result in crosslinking of macromolecules.

Peroxide L-101 ensures relatively high grafting efficiency, as the macro radicals formed have rather long life times at the experimental conditions as shown in Figure 4.5. The total residence time at 5 rpm screw speed for the reactive blend in the single screw extruder was 165 seconds. The result obtained offers an essential opportunity to use peroxides with lower thermal stability for initiating the grafting reaction.

Peroxide L-130 exhibited much weaker initiating activity as compared with L-101 and DCP; this can be explained by differences in solubility of peroxides in the components of the monomer- polymer reactive blend. Unlike L-101, peroxide L-130 is insoluble in HDPE. Therefore, results in poor dispersion [131], the forming and grafting reactions of macro radicals are only feasible in places where L-130 aggregates have local contacts with the HDPE phase. Since specific interactions can take place between L-130 and silane molecules, radical products of the peroxide decomposition can obviously initiate silane oligomerisation in molten HDPE.

Hence, the course of grafting reactions and yield of the grafted product during reactive extrusion depends, mainly, not on the reactivity of the peroxide initiator but on its solubility in the initiator components of the reactive system. It is also confirmed that oligomerisation of the grafted monomer is hardly possible, if the solubility parameters of the polymer and the peroxide differs much.

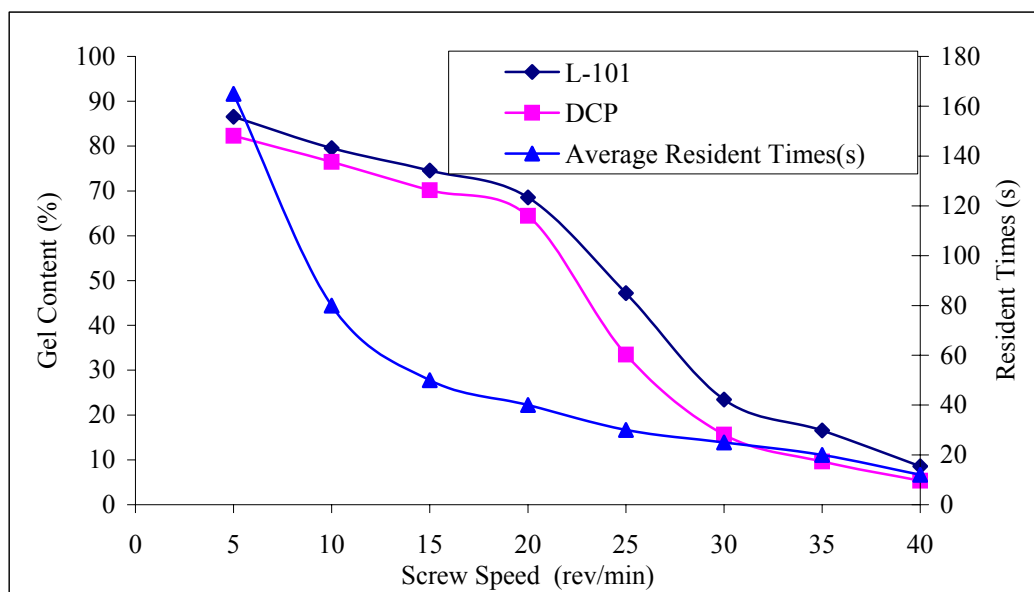

Figure 4.5: Effect of screw speed of rotation and average resident times on gel content of crosslinked HDPE at VTMO: 2.0 phr, DBTL: 0.01 phr

Effects of other peroxides on the gel content and melt flow index onto silane grafted HDPE are shown in Table 4.4. When compared, the data in Table 4.4 indicates that L-DI had the lowest initiating activity for 0.1 to 0.3 phr concentration; the crosslinking efficiency was between 11 and 38%; with increasing concentration, the degree of HDPE crosslinking increased significantly.

Table 4.4. Effect of peroxide on efficiency of grafting and melt flow index of silane crosslinkable compound.

Peroxide	Concentration of Peroxide (phr)	Efficiency of grafting (%)	Melt Flow index (g/10min)
Dicumyl peroxide- (DCP)	0.1	35.57	0.34
	0.2	64.89	0.32
	0.3	69.00	0.24
2,5-dimethyl-2, 5-di (tert-butylperoxy)-hexane -(L-101)	0.1	48.56	0.29
	0.2	70.15	0.20
	0.3	78.45	0.15
Di-Tert-butyl peroxide -(L-DI)	0.1	11.00	0.345
	0.2	23.00	0.323
	0.3	38.00	0.290

L-DI differs from other peroxides by high volatility, low thermal stability (Table 4.3), and high concentration of active oxygen (Table 4.2). When it decomposes, the yield of active radicals ($\bullet\text{OC}(\text{CH}_3)_3$) and ($\bullet\text{CH}_3$) [132] is higher than with the remaining tested peroxides. Therefore, more HDPE macro radicals can, probably, be formed as early as in the extruder's feed zone; these radicals are preferably recombined with each other. Therefore, L-DI ensures high yield of the crosslinked polymer at low grafting efficiency of silane.

Dicumyl peroxide (DCP) is similar to peroxide L-101 in its efficiency in initiating the grafting reaction of silane to HDPE at 0.1–0.3 phr concentration, as can be seen in Table 4.4. Somewhat lower grafting efficiency (about 30% at 0.1–0.2 phr concentrations) with DCP can be explained by a greater affinity between dicumyl peroxide and the monomer (Table 4.2).

It should be noted that within the concentration range between 0.1 and 0.3 phr, the grafting degree of the polymer is much lower with dicumyl peroxide than with L-101 diperoxide (the efficiency of grafting and MFI are listed in Table 4.4). The decomposition temperature range for DCP is optimal from the silane-grafting viewpoint based on Table 4.4 data. A maximum amount of free radicals should be formed during DCP decomposition when silane is in the molten reactive state. Therefore, despite lower concentration of active oxygen in DCP, as compared with other peroxides.

The differences in the reaction course of grafting and crosslinking, detected for certain peroxides (Figures.4.3, 4.4 and Table 4.4) remained after the rotation speed of the extruder screw was varied within a wide range, the reactive blend transportation speed depends on this screw rotation speed, and hence on the duration of chemical conversions (Figure .4.5). Consequently, the peroxide nature is of prime importance for radical reactions at the present experimental conditions, and not the processing parameters, which influence the duration of interaction between the reactants.

DCP, easily initiated VTMO grafting reaction and macromolecular crosslinking, as shown by a substantial decrease in the MFI, implying an intensive crosslinking in silane with HDPE system, if the rotation speed of the screw was raised from 5 to 40 rpm (the residence time decreased from 165 s to 12 s as observed in Figure 4.5. This is probably due to a VTMO and peroxide cannot easily dissolved and diffused in HDPE, the grafting efficiency might be decreased by shorter reaction time and lack of molecular contact between VTMO and the formed macro radicals. Therefore, these macro radicals are predominantly consumed in the recombinative reactions with each other leading to crosslinking.

At other equal conditions, the solubility of peroxide initiator in the molten polymer decisively affects grafting of VTMO onto HDPE. This conclusion was agreed by research findings reported by Hogt and coworkers [134]. The thermal

stability of the peroxide initiators is also important. When grafted products were synthesized by reactive extrusion, peroxides that decomposed at temperatures much lower than the VTMO melting point can be used to initiate the grafting reactions also in the feeding zone of the extruder reactor. It is most probable that radicals formed during peroxide decomposition first interact with HDPE, and then the formed macro radicals initiate VTMO-grafting reactions. Peroxides, which can dissolve easily in HDPE, are effective in initiating the grafting reactions. Increased thermodynamic affinity between the peroxide and monomer would decrease the efficiency of grafting. Higher rates of transportation of the reactive blend in the extruder-reactor both intensify crosslinking of HDPE and decrease the silane grafting efficiency.

4.4 Selection of Crosslinking Catalyst

The formation of a spatial network consisting of polyethylene chains tied together by Si-O-Si linkages occurs in the second phase of the siloxan process with the aid of moisture. The crosslinking catalyst plays an important role in this phase with respect to the degree of crosslinking that may be achieved.

The precise role of the catalyst in the chemistry of silane crosslinking is not known and it is believed that both hydrolysis and condensation reactions are catalyzed. There has been some investigation of crosslinking systems without a catalyst and it shows that (a) a much lower degree of crosslinking (gel content) than in systems including a catalyst, both extrudates having been exposed to moisture for equivalent periods of time, (b) an exposed period of 10 times the standard exposure applied to an extrudate without catalyst will give a gel content that is lower than the gel content of an extrudate with a catalyst after a standard exposure period to moisture [95].

Concentration of the catalyst may be varied over a wider range. The standard concentration in the siloxan process is 0.01 phr (the lower limit is about 0.005 phr). Lower concentration than 0.01 phr lead to reductions in degree of crosslinking and require longer periods of exposure to moisture, while concentration exceeding 0.015 phr causes premature reactions during extrusion (increased melt viscosity) and may lead to processing problems. The feeding stability of the extruder may also be affected by an overdose of the oily catalyst. From Figure 4.6, it can see that increasing the dosage over 0.01 phr does not significantly increase the amount of gel content.

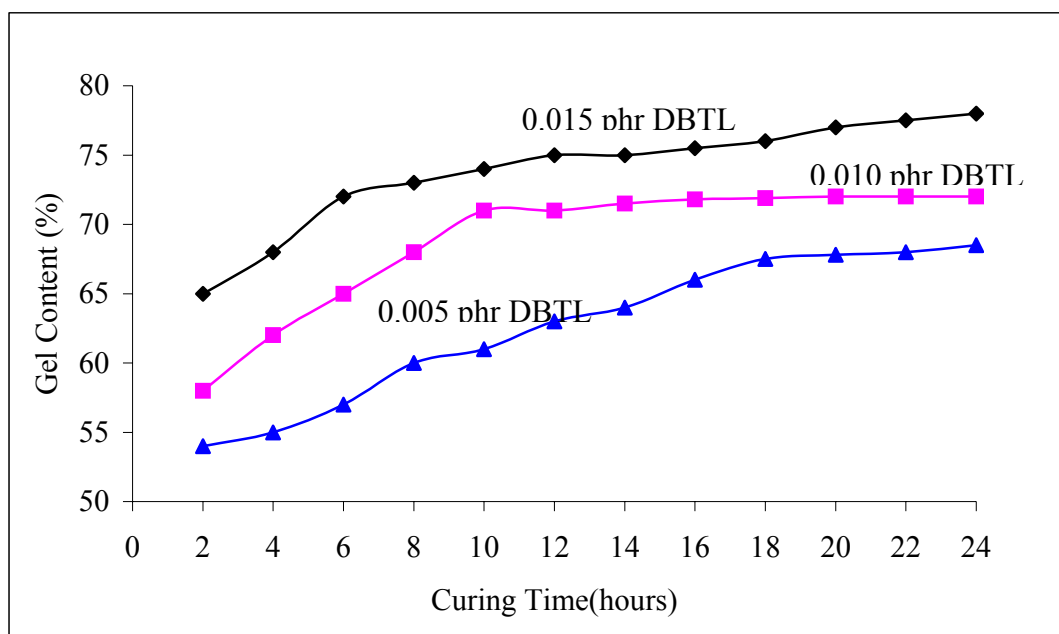

Figure 4.6: The Effect of the DBTL concentration on the crosslinking speed at VTMO: 2.0 phr. DCP: 0.2 phr.

4.5 Selection of Antioxidants System For Crosslinkable Polyethylene

In silane crosslinkable HDPE compound for extrusion blow-molding applications there is a critical balance between the additives. Normally DCP is applied as the free radical initiator and stabilizers are needed towards thermo-oxidative degradation as described by ASTM D2242 standard specification for crosslinked ethylene plastics [135]. In addition, the phenomenon known as premature crosslinking referred to as “scorch”, demands that a certain amount of a phenolic stabilizer deactivates radicals formed during the extrusion step. The aim of this study was to correlate the structure of different phenolic antioxidant to their capability to react with radicals formed during the extrusion, which would give information in design of new compounds for which scorch properties are of importance.

4.5.1 Aspects Regarding The Selection of Antioxidants

Besides the function of the antioxidant as a stabilizer, also additional aspects have to be considered. In order to secure the thermo-oxidative stability, a certain minimum concentration of the antioxidant must remain in the crosslinked polyethylene during the whole life cycle of the product. To minimize the diffusion to the surrounding product surface, the compatibility of the antioxidants has to be addressed. Compatibility is also important to minimize the risk for migration out to the surface of the raw material granulates supplied to the blow-molded manufacturer to be used in the extrusion process. Antioxidants and other additives on the pellet surface might give rise to dust and thus cause practical difficulties in the materials handling. The low amount of extractable antioxidants usually found in the cross-linked polyethylene is also referred to as a grafting reaction [136,137]. It is evident that a balance between the efficiency of the antioxidant, concentration, and compatibility as well as its interaction with the silane and peroxide has to be found.

It is known that most antioxidants reduce the effectiveness of the peroxide [78] and the presence of antioxidants will thus suppress the crosslinking reaction and a higher amount of peroxide to reach the degree of crosslinking will be needed [138,139]. Premature crosslinking in the extruder and extruder head will result in homogeneities that can come loose and get into the blow molded product, forming a defect that can jeopardize the performance of the final blow molded product.

The selection of antioxidant is also of importance with regard to the performance of the blow molded under long-term thermo-mechanical stress. It has been shown that the selection can influence degradation under high service temperature [140]. The selection of antioxidant is thus strongly restricted by the mentioned criteria and limits the possible candidates available today.

Primary antioxidants are normally used to achieve thermo-oxidative stabilization. These phenolic antioxidants are, however, active during the extrusion process [141,142] and prevent minute amounts of decomposed peroxide to facilitate crosslinking already at this stage. Later, in the crosslinking reaction, radicals are being formed which partly will react with the phenolic antioxidants left and render them, at least partly, inactive:

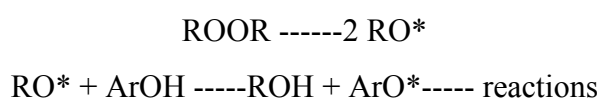

There are several aspects of this reaction. It is clear that the phenolic antioxidants (ArOH) will practically be deactivated. Another aspect is the consumption of peroxide in a “non-useful” reaction, which means that this portion has to be compensated for with additional peroxide. In order to achieve a satisfactory stabilization, a secondary antioxidant or antioxidant effect (bifunctional) has to be introduced. Sulfur-containing chemical compounds are normally employed. The thio

function of such a compound will not undergo any specific reactions due to the radical activity at the peroxide crosslinking stage.

As mentioned, one of the most critical issues in the formulating of silane crosslinkable compound is the premature crosslinking, “scorch”. In order to minimize scorch, a low temperature well below the decomposition temperature of the peroxide was applied to the extruder. This is the main reason why HDPE was employed as the base polymer. HDPE is well known for its homogeneity and its good extrusion behavior, which makes it possible to extrude and blow molded at temperatures between 170 and 180 °C, having a homogeneous melt. For dicumyl peroxide this is well below decomposition conditions for crosslinking. However, because a small portion of the peroxide always will be active, the phenolic stabilizer has a very important role to play. If no primary stabilizer were present, all the radicals formed would have the capability of reacting with the polymer, which would be a very detrimental reaction leading to such amount of scorch that the blow molded bottle would in practice be useless. It can be seen that most of the peroxide radicals formed in this step will be controlled by the primary antioxidant and thus a much safer extrusion of the blow-molded product is possible.

The work started by screening different type of phenols antioxidant uses in this studied as listed at as shown at Table 4.5, with regard to their scorch properties, in a formulation of HDPE having a fixed amount of dicumyl peroxide (0.2 phr). Different amounts of antioxidant were added in order to be able to judge the scorch performance of the additives. The scorch time for the HDPE containing 0.2 phr dicumyl peroxide, but no antioxidant, is 10 minutes. Another type of HDPE having an increased amount of double bonds has been described by Smedberga, Hjertberg and Gustsfsson [21]. For this polymer a substantially higher peroxide response has been measured, when compared to the polymer used in this work. It was, however, interesting to observe that after a short crosslinking time (1 min) with antioxidant present, these different polyethylenes gave basically the same result. These points in the direction that the radical scavenging effect of the phenolic stabilizers is

substantial. The results obtained for the different antioxidant studied in standard HDPE are listed in Figure 4.7.

Table 4.5: Structure of Antioxidant Tested [93]

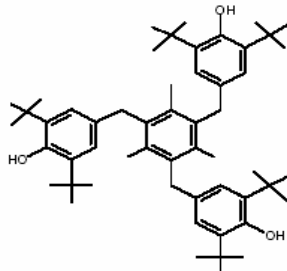
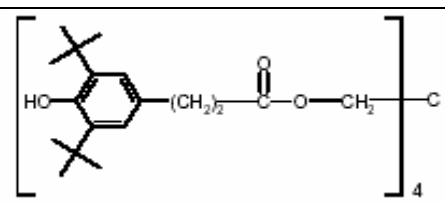
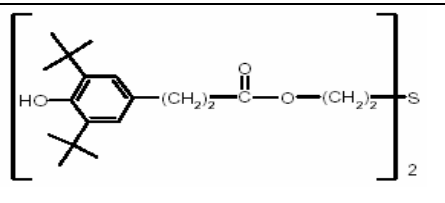
Type of Phenol Antioxidant	Brand Name	Structure of compound	Mw
(Tris-phenoles) 1,3,5-Trimethyl-2, 4,6-tris (3,5-di-t-butyl-4-hydroxybenzyl) benzene	Irganox 1330		775
Tetrakis [methylene (3,5-di-t-butyl-4-hydroxyhydrocinnamate)] methane	Irganox 1010		1178
Thiodiethylene bis [3-(3,5-di-tert-butyl-4-hydroxyphenyl) propionate] (Dual functionality)	Irganox 1035		643

The scorch times obtained are plotted against the weight percent of each antioxidant as shown in Figure 4.7. All of the phenolic antioxidants studied showed a scorch retarding effect. A comparison of the different phenols on a weight percent basis shows that tris- hindered phenoles (AO-1330) gives the best scorch resistance to the formulation, followed by the sterically hindered phenolic (AO-1010), and finally dual functionality hindered phenol (AO-1035). In order to compare the different phenols on a chemical basis, a comparison can easily be done where the

molar weights are taken into account. After such a calculation a few of the sterically hindered phenols reveal a better scorch retarding performance compared to the dual functionality hindered and tris-hindered phenols. When taking into account that the phenols contain a different amount of active hydroxyl groups, a somewhat different picture is obtained regarding the scorch retarding efficiency of the phenols studied. In silane crosslinkable HDPE blow-molding compound the most important property is processability.

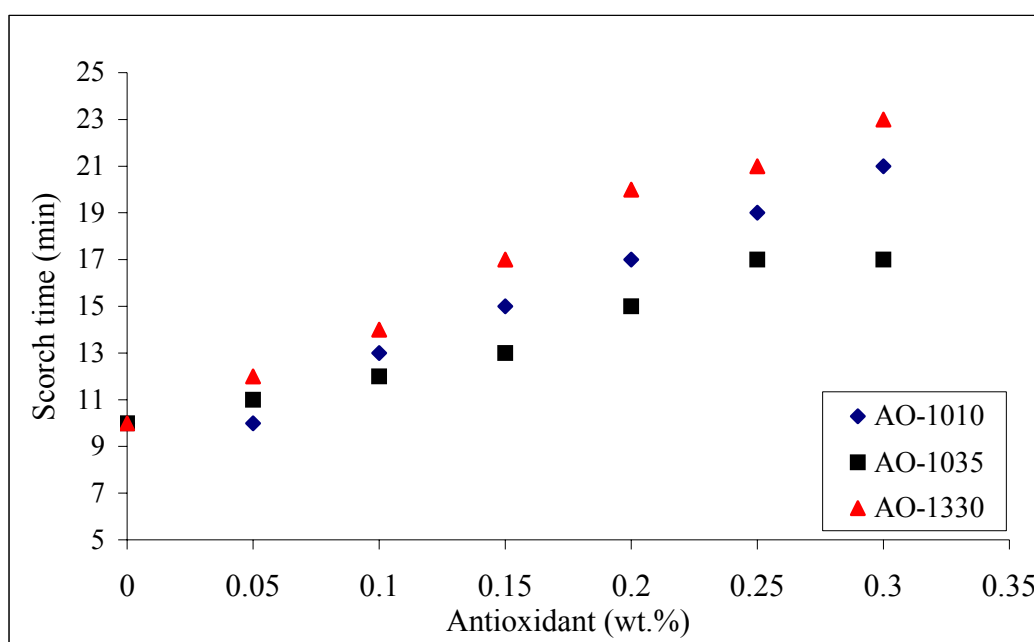

Figure 4.7: The scorch time plotted against the concentration by weight percent (wt %) of antioxidants.

Research have thus seen that, in general terms, the less hindered a phenolic stabilizer is, the higher capability of reacting with peroxide radicals it has. The drawback with this type of phenols is that despite their high reaction capability with the peroxide employed they are practically useless as stabilizers. In order to check how much peroxide is consumed by the antioxidant a few formulations were prepared. The antioxidant was compounded into HDPE and the peroxide responses were measured as described above. The results can be seen in Figure 4.8.

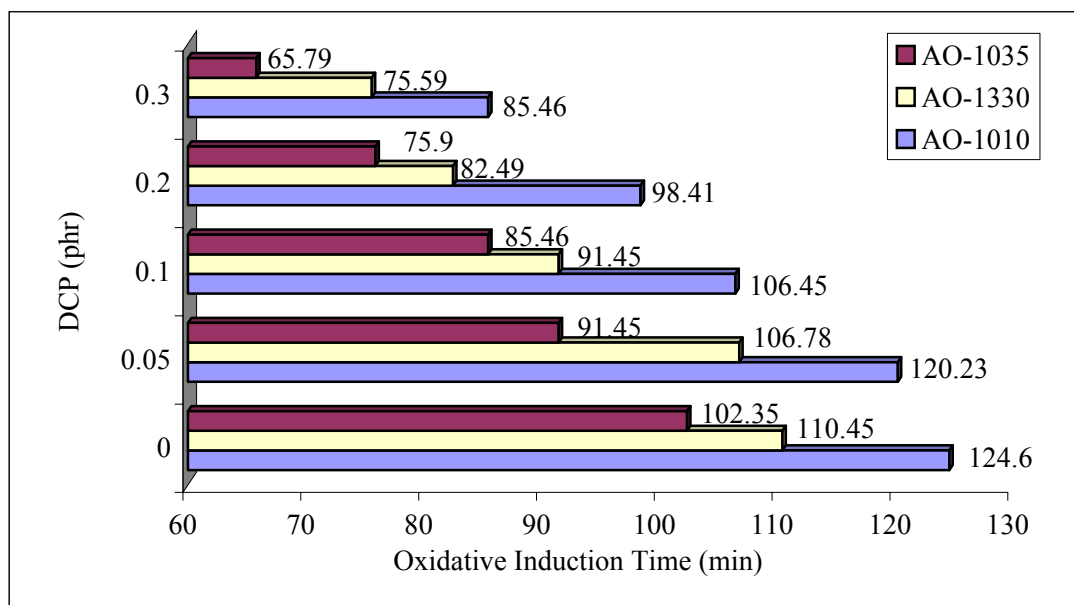

Figure 4.8: The oxidation induction time (min) plotted against the DCP content (phr) with fix amount (0.3 wt %) of antioxidants

All antioxidants consume some of the dicumyl peroxide during extrusion. The worst to interfere is the less hindered phenol, followed by the semi hindered and the hindered ones. In order to reach a degree of crosslinking for a crosslinkable formulation, the peroxide dosage levels need to be increased. This might cause problems of exudation of peroxide from the formulation. Despite that, for some formulations the right amount of peroxide needed for a targeted crosslinking degree was added and thermo-oxidative ageing properties were studied. The formulation containing only a hindered phenol (AO-1330) failed within 24 hours at 150°C in short term thermal ageing test. Only with the presence of right type and concentration the ageing criteria could be fulfilled. This means that in order to fulfill thermo-oxidative ageing requirements additional stabilization package is needed in the form of a secondary antioxidant [143].

4.5.2 Retardation of Crosslinking Reaction of HDPE with Antioxidants

Retardation of crosslinking by antioxidant was examined employing three different phenol types of antioxidant. AO-1010 was used as a typical sterically hindered phenol and antioxidant tris- hindered phenoles (AO-1330) and dual functionality hindered phenol and (AO-1035) were used as comparison purpose. HDPE was blended with DCP (2.0 phr) and varied amounts of AO, then cured at 100°C in boiled water for 100 minutes followed by gel content measurements. The results are given in Figure 4.9.

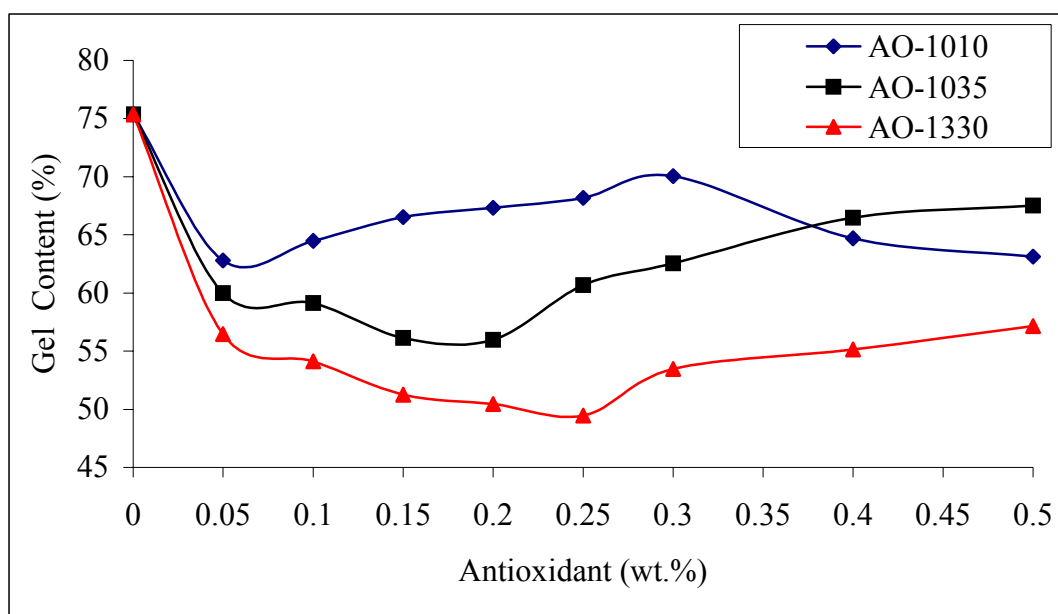

Figure 4.9: The effect of types of antioxidant and concentration on the gel content.

The decreased of the gel content was observed by increasing the amount of AO-1010. This may suggests that H-abstraction from AO-1010 is predominant to that from HDPE. With 0.05 wt % of AO-1010, less degree of crosslinking HDPE was detected, implying that the crosslinking was completely retarded. This can be explained by the fact that 0.5 wt % of AO-1010 exactly corresponds to 0.02 phr of DCP, stoichiometrically. On the other hand, the AO-1010, acts as a weak retarded

and the crosslinking reaction proceeds somewhat normally even under the presence of an excess amount of phenol antioxidant.

4.6 Investigation of Curing Reaction of Silane Grafted HDPE

Figures 4.10 and 4.11 show plots of gel content of the silane grafted cross-linked HDPE as a function of crosslinking time at various temperatures for 1.8-phr silane grafted blow molded samples with thickness of 0.5 ± 0.05 and 1.0 ± 0.05 mm, respectively. As can be seen in Figures 4.10 to 4.12, the gel content increased with increasing time and at 100°C of water temperature, up to around 71.23% of gel content can be reached for 50 h of crosslinking. The gel content increased with the crosslinking time up to 50 h if the reaction temperature was 80°C and above for the sample of 0.5 ± 0.05 mm in thickness (Figure 4.10) but was 95°C and above for the sample of 1.0 ± 0.05 mm in thickness (Figure 4.11). This implies that the relationship between gel content and crosslinking time is dependent on the thickness and the content of crystalline component of the silane grafted HDPE sample.

Figures 4.12 -4.15 show plots of gel contents of 0.5 ± 0.05 mm thick HDPE samples with various silane-grafting extents as functions of crosslinking times at 60, 80, 100, and 105°C , respectively. As can be seen in Figure 4.12, for 60°C , the gel content was almost linearly related to the crosslinking time up to 50 hour for samples grafting with 1.6, 1.8, and 2.0-phr silane. The slope of a plot in Figure 4.12, that is, the crosslinking rate of a silane-grafted sample, is in the order of 2.0-phr > 1.8-phr > 1.6-phr silane-grafted sample. At this temperature of 60°C and for 50 hours of crosslinking, the 2.0-phr silane-grafted sample lead to the highest gel content (around 33.95%) among the three samples with different silane grafting extents.

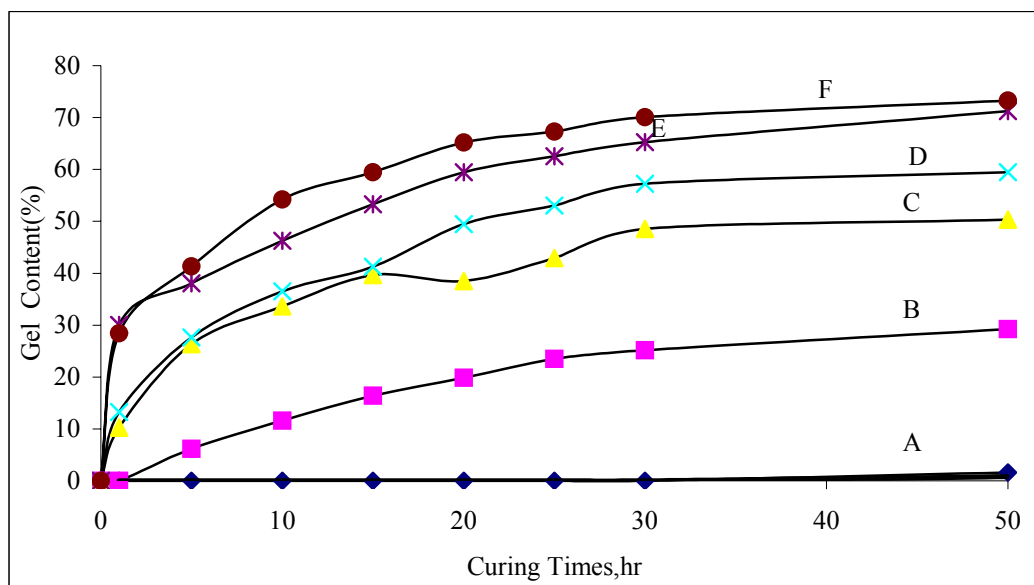

Figure 4.10: Plots of the gel contents of the 1.8-phr silane-grafted HDPE bottle samples with 0.5 ± 0.05 mm in thickness as a function of crosslinking time at (A) 30°C , (B) 60°C , (C) 80°C , (D) 95°C , (E) 100°C , and (F) stream (1bar).

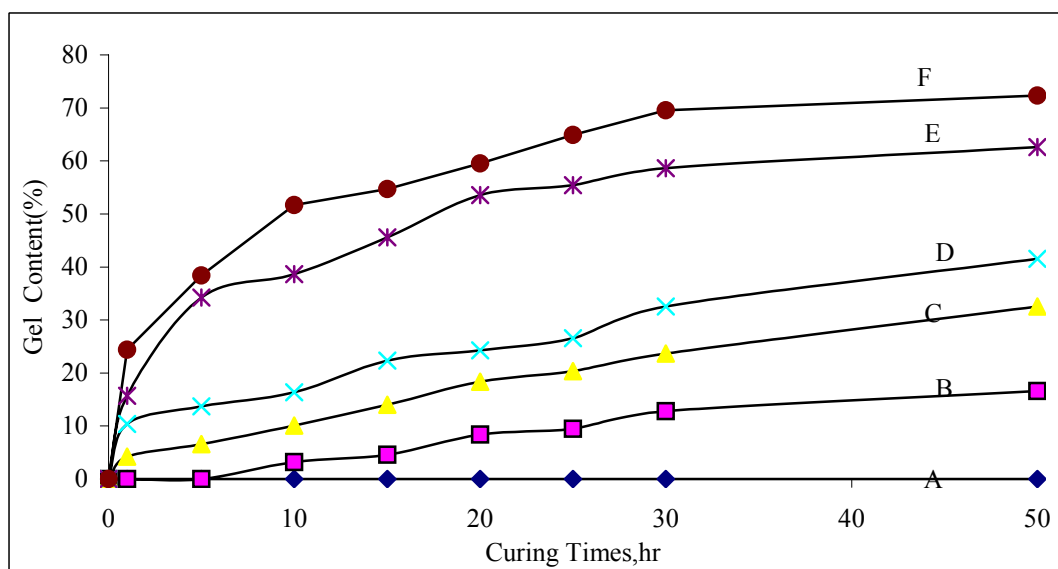

Figure 4.11: Plots of the gel contents of the 1.8-phr silane-grafted HDPE bottle samples with 1.00 ± 0.05 mm in thickness as a function of crosslinking time at (A) 30°C , (B) 60°C , (C) 80°C , (D) 95°C , (E) 100°C , and (F) stream (1bar).

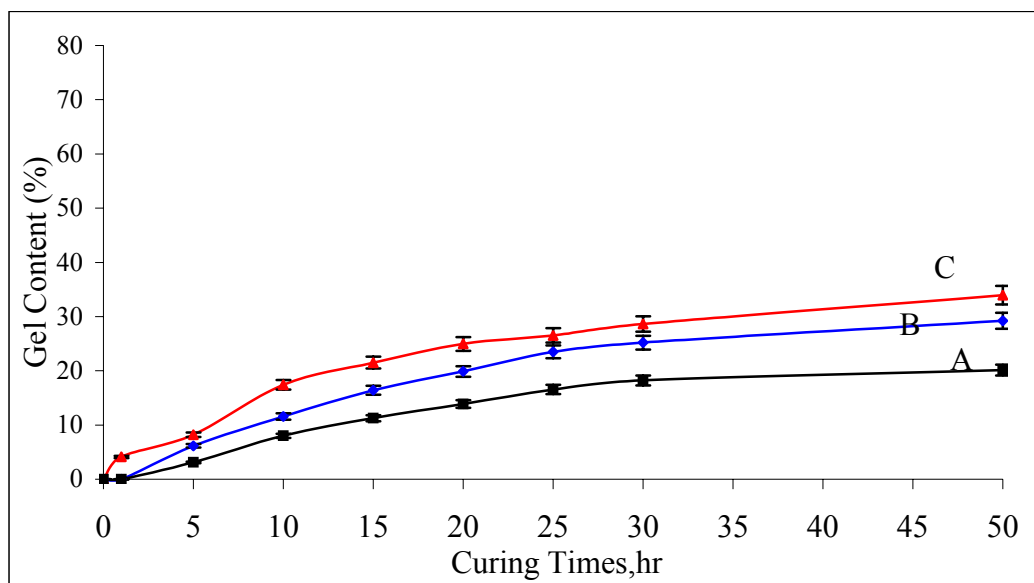

Figure 4.12: Plots of the gel contents of the (A) 1.6-phr, (B) 1.8-phr, and (C) 2.0-phr silane-grafted HDPE samples with 0.5 ± 0.05 mm in thickness as a function of crosslinking time at 60°C .

As can be seen in Figures 4.13 and 4.14, for 80 and 100°C , the gel contents were not linearly related to the crosslinking times throughout the study range of 0 to 30 hours for samples with 1.8 and 2.0 phr of silane grafting. The relations of gel contents and crosslinking times for these two samples can be fitted with two different slopes of straight lines connecting at a point falling, as seen in plots B and C of Figures 4.13 and 4.14, in the range of 30-40% of gel content. The initial crosslinking rates (i.e., slopes of the initial linear portion of the fitted straight lines) of samples at these two temperatures (80 and 100°C) also follow the same order as that at 80°C , that is, $r_{2.0 \text{ phr}} > r_{1.8 \text{ phr}} > r_{1.6 \text{ phr}}$.

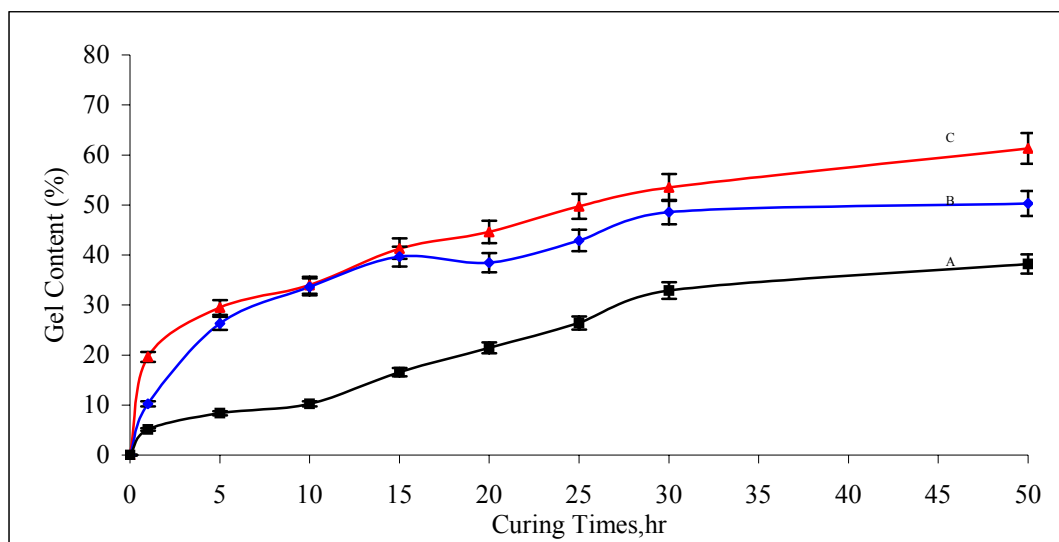

Figure 4.13: Plots of the gel contents of the (A) 1.6-phr, (B) 1.8-phr, and (C) 2.0-phr silane-grafted HDPE samples with 0.5 ± 0.05 mm in thickness as a function of crosslinking time at 80°C.

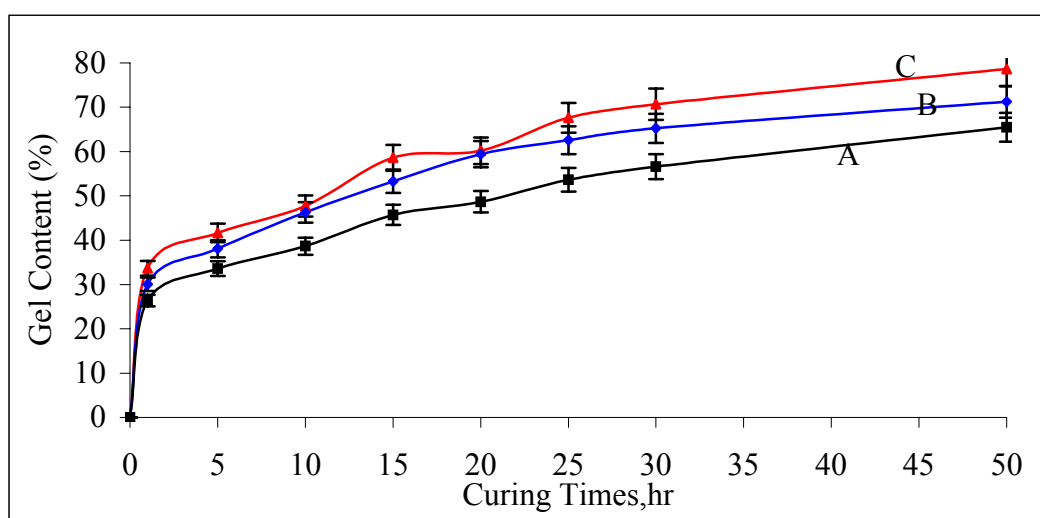

Figure 4.14: Plots of the gel contents of the (A) 1.6-phr, (B) 1.8-phr, and (C) 2.0-phr silane-grafted HDPE samples with 0.5 ± 0.05 mm in thickness as a function of crosslinking time at 100°C.

The gel content was not linearly related to the crosslinking time for samples having 1.8 and 2.0-phr silane grafting (Figures 4.13, 4.14 and 4.15). This is probably due to the diffusion of water in the sample was governed by, in addition to the content of crystalline component, the perfection or size of crystallite of the sample. As discussed previously, the perfection or size of crystallite in a sample increased with increasing gel content in the sample. As the gel content in the sample was higher than 30-40% as observed in Figures 4.14 and 4.15, the perfection or size of crystallite in the sample was enhanced, as demonstrated by DSC, Figure 4.16. This enhanced perfection or size of crystallite gave a lower diffusion rate of water and, thus, a lower crosslinking rate leading to a lower slope of the plot as shown in Figures 4.16 and 4.17 for the later stage of crosslinking reaction.

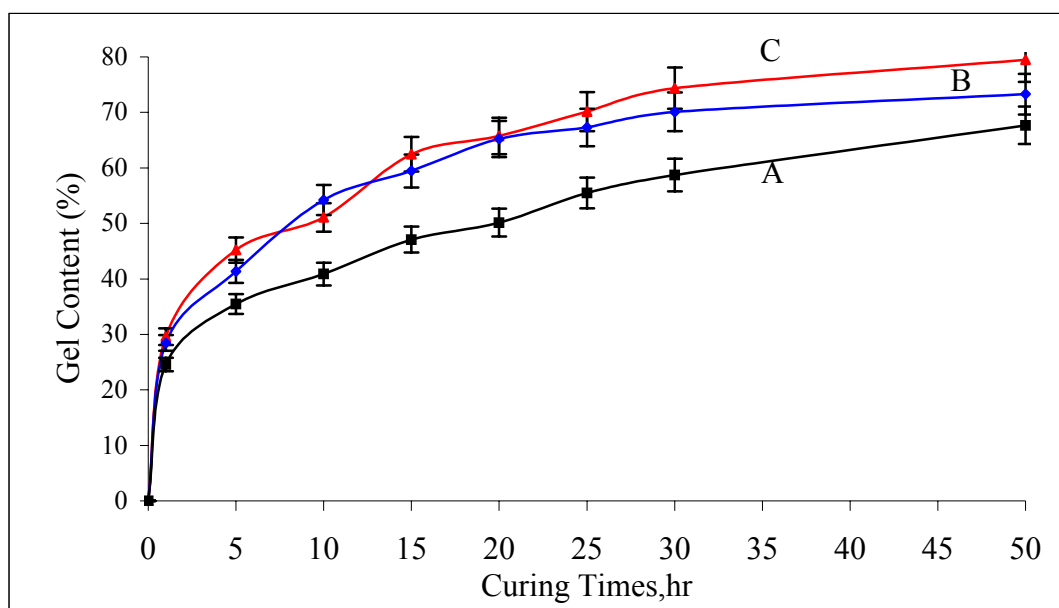

Figure 4.15. Plots of the gel contents of the (A) 1.6-phr, (B) 1.8-phr, and (C) 2.0-phr silane-grafted HDPE sample with 0.5 ± 0.05 mm in thickness as a function of crosslinking time at 105°C .

In Figure 4.16, it is observed that the endothermic melting peak for the silane-grafted HDPE sample started at around 60°C , which was much lower than its main melting temperature (T_m) at around 110°C . In other words, the sample started to

melt at around 60 °C, and the melting increased with increasing temperatures until around 110°C before which the content of the crystalline component decreased with increasing temperatures. The content of the crystalline component in a sample at a temperature in the range of 60 °C(T_m) can be determined by the integration of the endothermic peak area (i.e., the heat of fusion) from the temperature to 140°C.

The calculation of the content of crystalline component in a sample was performed by dividing the heat of fusion of the sample by that of the polyethylene crystal. The heat of fusion of the polyethylene crystal is 281 J/g [144]. The contents of the crystalline component in the 1.8-phr silane-grafted HDPE sample at 60, 70, 80, 90, 100, 105 and 120°C are, thus, 63.50, 59.92, 58.81, 56.59, 51.05, 48.81 and 32.86 % calculated from temperature ranges of 60-140, 70-140, 80-140, 90-140, 100-140°C, 105-140°C and 120-140°C, respectively.

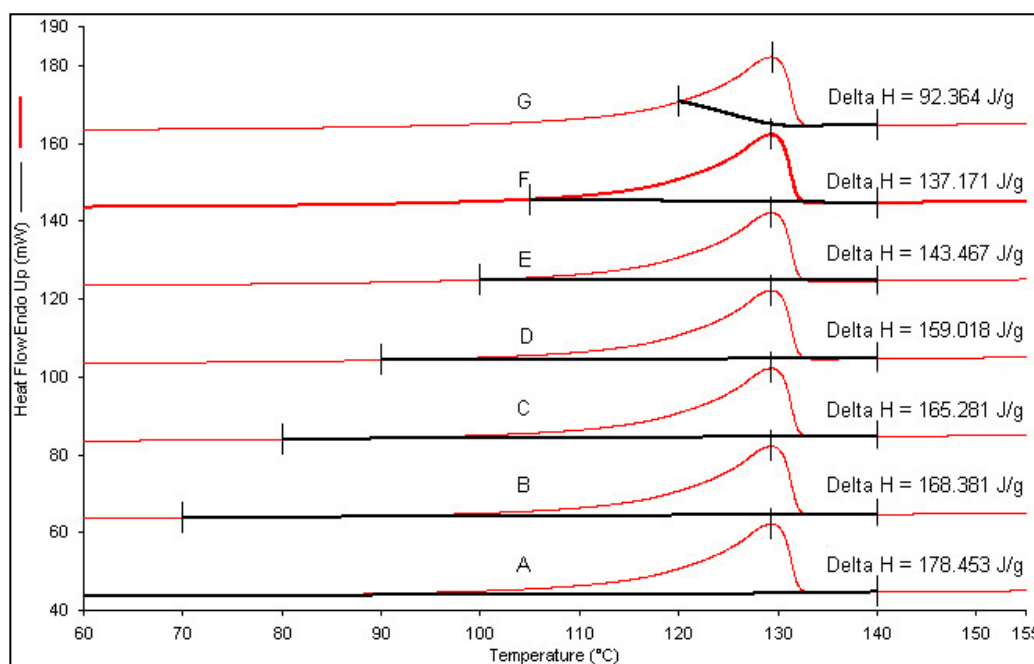

Figure 4.16. DSC thermograms with the area integration of the endothermic peak from (A) 60°C, (B) 70°C, (C) 80°C, (D) 90°C, (E) 100°C, (F) 105°C, (G) 120 °C to 140°C for the 1.8 phr silane-grafted HDPE sample.

Diffusion of water in the amorphous domain was faster than that in the crystalline domain. This suggests that the crosslinking rate in the amorphous domain is faster than that in the crystalline domain. Having a higher content of the amorphous component in a silane-grafted HDPE sample at a higher temperature (Figure 4.16), a faster crosslinking rate for the sample can be obtained as shown in Figures 4.11 to 4.15, and a longer time can be reached for the sample to maintain a linear relationship between the gel content and the crosslinking time (Figures 4.10 and 4.11). The effect of the crosslinking temperature on the gel content of the water-crosslinked sample was complicated, because the temperature affects not only the content of the crystalline component (Figures 4.16) and, thus, the diffusion rate of water but also the subsequent hydrolysis and condensation rates of the silyl trimethoxy moiety.

Figures 4.11 to 4.15 show that the gel contents of the samples conducted for a certain crosslinking time increased with increasing temperatures. It is, thus, demonstrated that the diffusion rate of water and the subsequent hydrolysis and condensation rates of the silyl trimethoxy moiety increased with increasing temperatures. From Figures 4.11 to 4.15, the fitted curves on plots of the gel content versus the crosslinking time are considered to be linear in the initial hours.

Table 4.6 lists initial crosslinking rates (%/hour), determined from slopes of the initial linear portions of the fitted straight lines at various crosslinking temperatures for two different thicknesses of samples with various silane-grafting extents. The amount of silane used for samples being 0.5 ± 0.05 mm thick, includes 1.6, 1.8, and 2.0 phr and for samples being 1.0 ± 0.05 mm thick was 1.8 phr.

Table 4.6. Initial crosslinking rates (%/hour) at various crosslinking temperatures for two different thicknesses of silane-grafted HDPE samples

	Thickness :0.5±0.05mm			Thickness 1.0±0.05mm
Crosslinking Temperature	1.6 phr	1.8 phr	2.0 phr	1.8 phr
60°C	0.4485	0.6312	0.6733	0.3693
80°C	0.7834	0.8973	1.0376	0.6334
100°C	1.0426	1.1426	1.2516	1.1044
105°C	1.0935	1.1876	1.2983	1.2174
The amount of silane used for the 0.5±0.05mm thick silane-grafted HDPE samples includes 1.6, 1.8, and 2.0 phr and for the 1.0±0.05mm thick samples is 1.8 phr.				

The slopes of these initial linear portions of lines were used to determine the crosslinking rates of samples. Table 4.6 lists crosslinking rates of samples studied at various temperatures. For the 1.8-phr silane-grafted HDPE samples, it was found that the crosslinking rates of the thinner sample were higher than those of the thicker sample at temperatures of 100°C and below. The crosslinking rates at 100°C were almost similar within the experimental error for both samples in different thickness.

The difference of the crosslinking rates between these two samples increased as the temperature decreased. This suggests that the control variable in the crosslinking process was the diffusion of water in the sample at low temperatures. In other words, the diffusion of water was the rate determining step in the crosslinking process at low temperatures. The effect of this diffusion control on the crosslinking rate appeared to be insignificant at 100°C, at which the content of crystalline component was low and the chemical reaction rate was high and, thus, the chemical reaction control dominated the crosslinking process. This chemical reaction control in the crosslinking process was also evidenced from the crosslinking rates of both 1.8-phr and 2.0-phr silane-grafted HDPE samples at 80 °C and 100°C (Table 4.6). As

can be seen in Table 4.6, insignificant differences in crosslinking rates at 80 and 100 °C were demonstrated for both samples due to much higher crosslinking rates at these temperatures compared with crosslinking rates for the 1.6-phr silane-grafted samples. Table 4.7 lists the gel contents of those samples in Table 4.6 after crosslinking for 50 hours at various temperatures. As listed in Table 4.7, the 0.5±0.05mm thick sample with 2.0 phr silane grafting gave higher gel contents than those samples with 1.8 or 1.6 phr silane grafting after crosslinking for 50 h at temperatures studied. Gel content of as high as 73.46% for the 0.5 mm thick sample with 2.0-phr silane grafting was obtained after crosslinking for 50 hours at 105 °C.

Table 4.7. The gel contents (%) of two different thicknesses of silane-grafted HDPE samples after crosslinking for 50 hours at various temperatures.

	Thickness :0.5±0.05mm			Thickness 1.0±0.05mm
Crosslinking Temperature	1.6 phr	1.8 phr	2.0 phr	1.8 phr
60°C	20.13 %	29.24 %	33.95 %	16.59 %
80°C	38.19 %	50.31 %	61.30 %	32.56 %
100°C	65.46 %	71.23 %	78.65 %	62.64 %
105°C	67.68 %	73.29 %	73.46 %	72.36 %
The amount of silane used for the 0.5±0.05mm thick silane-grafted HDPE samples includes 1.6, 1.8 and 2.0 phr and for the 1.0±0.05mm thick samples is 1.8 phr.				

Table 4.7 lists the gel contents of samples after crosslinking for 50 h at various temperatures. As can be seen the gel contents of samples increased with increasing temperatures. For the 1.8-phr silane-grafted samples, the gel content of the thinner sample was higher than that of the thicker sample at temperatures below 80°C. For 50 hours of crosslinking at 100°C and 105°C, the effects of samples thickness on the gel contents appeared to be insignificant because the crosslinking reactions were completed before the crosslinking process was ended at a time of 50

hours. For the 0.5 ± 0.05 mm thick samples, the gel contents increased with increasing silane-grafting extents at any crosslinking temperature studied. This is consistent with FTIR data, as shown in section 4.83, where the extents of silane grafting reactions are found to increase with increasing amount of silane used for the grafting reactions. Therefore, among many factors, the extent of silane grafting reaction is an important factor to the highest achievable gel content of sample.

The crosslinking reaction rate increased with increasing concentration (driving force) for of water as curing agent. Consequently, the crosslinking reaction proceeds in such a way that the hydrolysis and subsequent condensation reactions of the silyl trimethoxy groups with water begin initially on the surface of the sample followed by diffusion of the liberated water from the previous condensation reactions into the sample. The direction and driving force of the water diffusion into the sample are apparently dependent on the concentration (driving force) of water. The water can give the higher driving force of the water diffusion into the sample. The water diffused into the surface can then induce the next hydrolysis and condensation reactions of the silyl trimethoxy groups and lead to crosslinking of the sample. With this reaction scheme, a series of crosslinking reactions proceeds continuously until all silyl trimethoxy groups in the amorphous domain are completely consumed.

Figure 4.17 show plots of crosslinking rates as a function of content of crystalline component for two different thicknesses of samples. The crosslinking rates are inversely proportional to the contents of crystalline component for the samples. This is because the diffusion of water decreased with increasing content of the crystalline component in the sample. The crosslinking rate for the thinner sample was slightly less dependent on the content of crystalline component than that for the thicker one. Figure 4.18 shows plot of the gel contents of the two different thicknesses of samples after crosslinking for 50 hours as a function of the contents of crystalline component. The gel contents were also inversely proportional to the contents of crystalline component for the samples. The gel content of the thinner sample was also slightly less dependent on the content of crystalline component than

that for the thicker one. Figures 4.17 and 4.18 suggest that the crosslinking reactions occurred mainly in the amorphous domain of the sample.

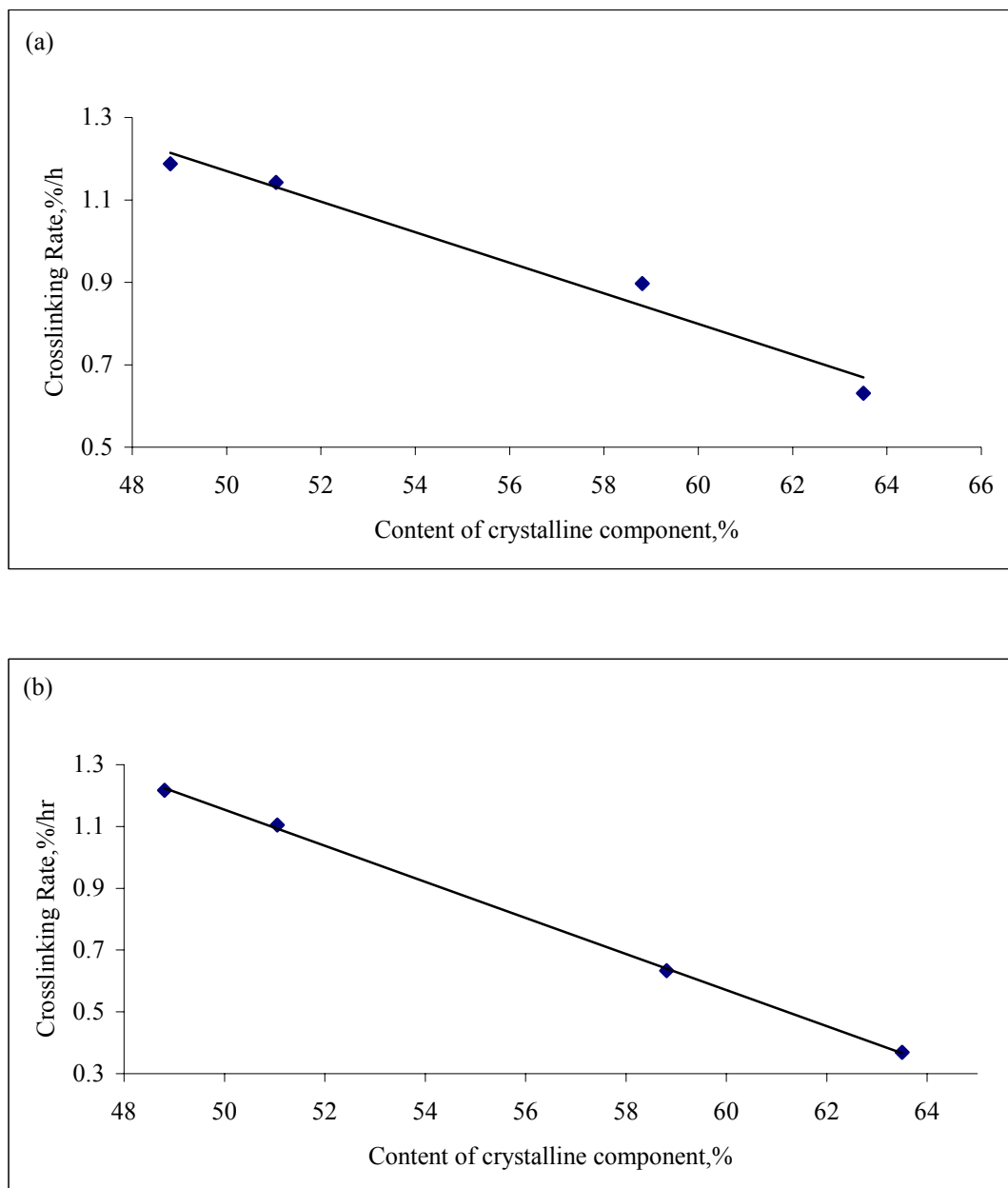

Figure 4.17: Plots of the crosslinking rates as a function of the content of crystalline component for the 1.8-phr silane-grafted HDPE samples with (a) 0.5 ± 0.05 mm and (b) 1.0 ± 0.05 mm thickness

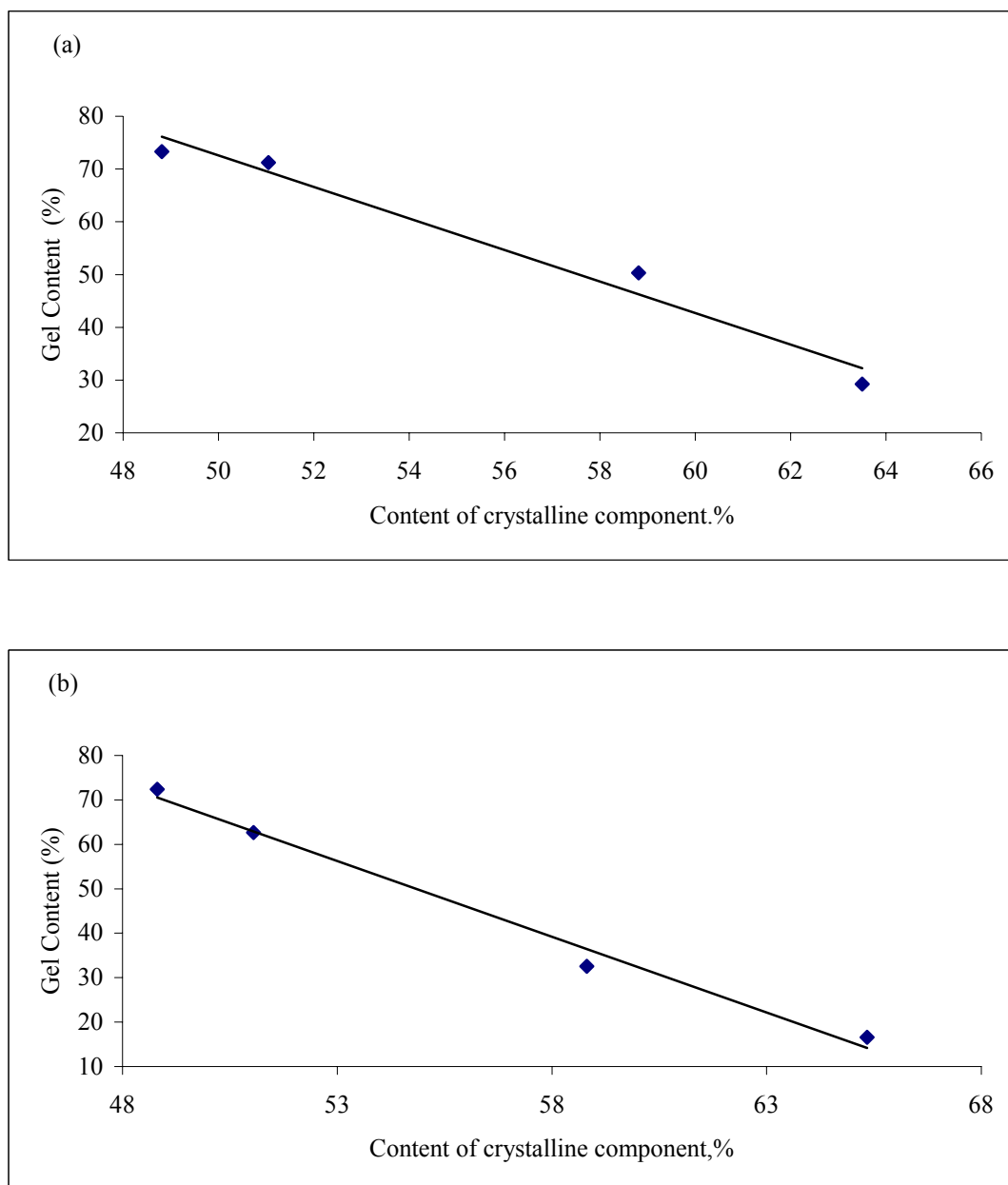

Figure 4.18. Plots of the gel contents as a function of the content of crystalline component for the 1.8-phr silane-grafted HDPE samples with (a) 0.5 ± 0.05 mm and (b) 1.0 ± 0.05 mm thickness.

Figure 4.19 shows plots of logarithmic crosslinking reaction rates for the two different thicknesses of 1.8 phr silane-grafted samples as a function of the reciprocal absolute temperature. The logarithmic crosslinking rates were found to be linearly

related to the reciprocal absolute temperatures. The plots can thus be described by the Arrhenius equation that follows.

$$r = A \exp (-E/RT)$$

Where r is the crosslinking rate (%/h), A is a pre-exponential constant, T is the absolute temperature (273.15 °C), and R is the gas constant (8.3142 J/mole. K) and E is the overall activation energy for the crosslinking reactions. Thus, the overall activation energies are the minus slopes of the fitted lines in the plots multiplied by the gas constant. The overall activation energies of the crosslinking reactions are thus 14.82 and 28.33 kJ/mol for samples of 0.5 ± 0.05 mm and 1.0 ± 0.05 mm in thickness, respectively. The overall activation energy is apparently dependent on the thickness of sample. The crosslinking reaction of the thinner sample has a smaller overall activation energy, and is thus less temperature dependent than that of the thicker one. As noted previously, the crosslinking reactions of the sample include the diffusion of water, the hydrolysis of the silyl trimethoxy groups by the water, and the subsequent condensation of the formed silanol groups to form crosslinks. The diffusion of water has been previously demonstrated to be the rate-determining step in the crosslinking reactions, and to be dependent on both the thickness and the content of crystalline component of the sample. These demonstrations support the findings that the overall activation energy of the crosslinking reactions is dependent on thickness of the sample, and the crosslinking reaction of the thicker sample is more temperature dependent than that of the thinner one.

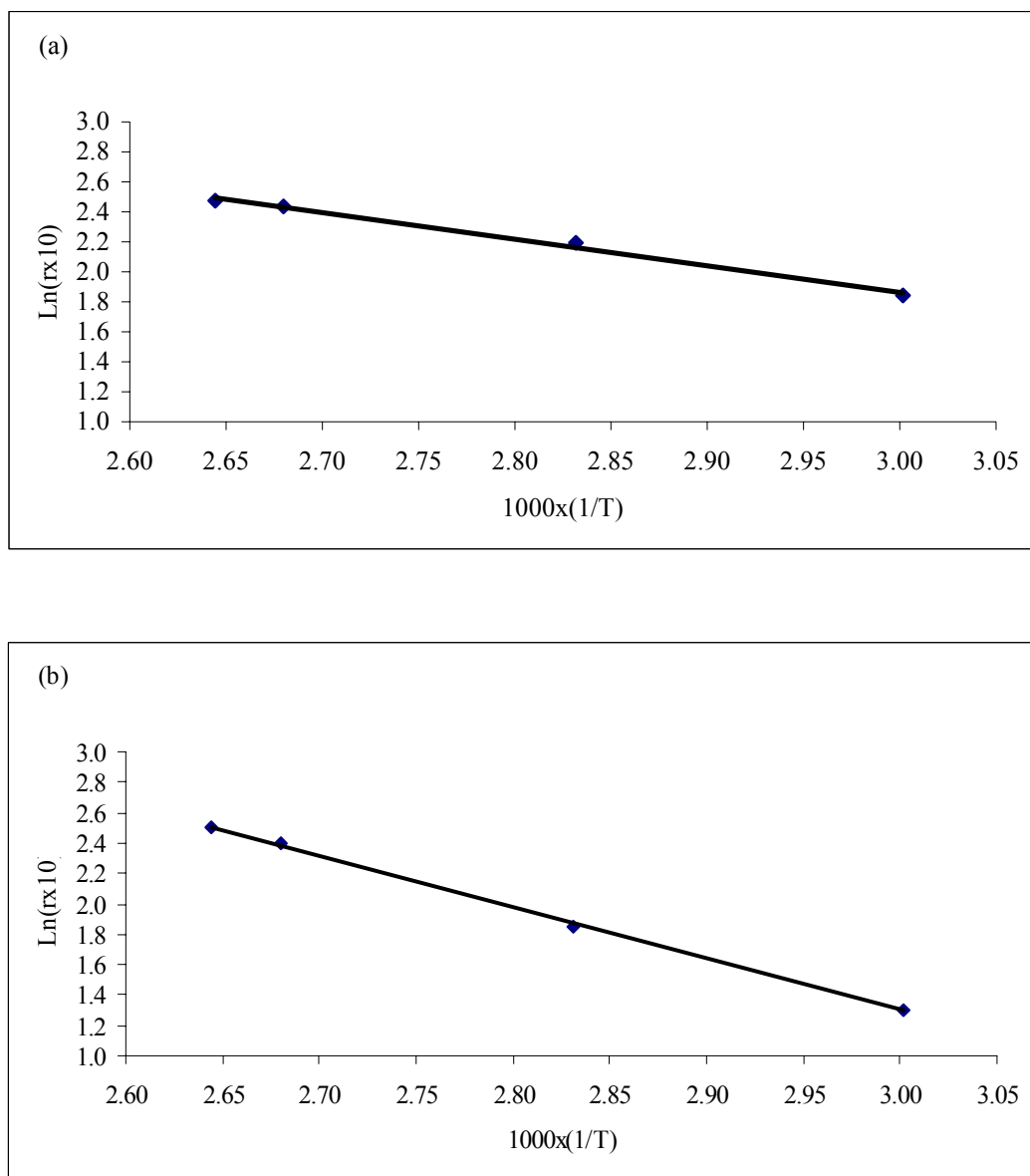

Figure 4.19. Plots of logarithmic crosslinking rates as a function of reciprocal absolute temperature for the 1-phr silane-grafted HDPE samples with (a) 0.5 ± 0.05 mm and (b) 1.0 ± 0.05 mm thickness.

4.7 Shelf Life of Silane Crosslinkable HDPE Compound

For every product on the market, crosslinkable compounder requires that the expiration-dating period must be indicated in immediate packaging label. The stability studies are usually conducted to characterize the degradation of the crosslinkable compound and establish the expiration-dating period. In this project, several practical issues that are commonly encountered in design and analysis of stability studies were examined. The main objective of stability studies was to allow for a reliable estimate of the shelf life to label crosslinkable compound. Under the standard manufacturing process, the potency of the crosslinkable compound was assayed at different time-points obtained from short and long-term testing conditions. Based on experimental data, two methods are suggested by this study. One is based on a chemical functional (chemical analysis) approach and the latter is on a crosslink network methodology (physical analysis). Overall stability quality must fulfill the cross-link ethylene plastic specification and process-ability.

4.7.1 Packaging and Storage

The packing systems consist of three separate components, i.e. PE liner (to protect aluminium bag), the aluminium bag (to act as moisture barrier) and the protective cover. The cover is Kraft paper bags strengthened with woven polypropylene. In this study, crosslinkable compound, a moisture sensitive compound, was packed in an aluminium sealed bag and aluminium unsealed bag. The packages were stored under standard tropical conditions at 25°C, 50% R.H. Evaluation and visual examination were carried out regularly to determine the compound quality. The methanol wash was determined by measuring the mechanical fines additives content of crosslinkable compound in open bag and sealed bag at certain interval times. The calculation provided an error of less than 10%. The results are summarized in Table 4.8.

Table 4.8: Methanol wash and visual inspection testing results

Storage (Days)	Aluminium Package (Type)	Hot set		Methanol wash		Visual examination on pellet
		EL set (%)	PM set (%)	Mechanical fine additives (ppm)	Soluble additives (ppm)	
0	Sealed	50	10	16621.29	2014.75	Free flowing
	Unsealed	50	10	16621.29	2014.75	Free flowing
1	Sealed	65	10	16600.26	2001.32	Free flowing
	Unsealed			12365.21	1235.68	Agglomeration
2	Sealed	65	10	15899.56	1795.12	Free flowing
	Unsealed			1568.56	902.41	Agglomeration
3	Sealed	73	10	13764.98	1686.89	Free flowing
	Unsealed			1004.78	346.12	Agglomeration
4	Sealed	84	10	12338.56	1594.56	Free flowing
	Unsealed			979.74	154.55	Agglomeration
10	Sealed	105	10	8825.15	1129.24	Free flowing
	Unsealed			909.33	127.96	Agglomeration
20	Sealed	130	15	7493.00	1036.56	Free flowing
	Unsealed			722.47	93.46	Agglomeration
30	Sealed	130	15	6849.00	875.42	Free flowing
	Unsealed			203.56	81.36	Agglomeration
60	Sealed	135	20	4301.17	803.46	Free flowing
	Unsealed			105.69	72.91	Agglomeration
90	Sealed	150	20	3764.18	756.81	Free flowing
	Unsealed			98.45	69.46	Agglomeration
120	Sealed	150	30	3743.05	723.65	Free flowing
	Unsealed			89.45	61.46	Agglomeration
150	Sealed	160	30	3704.40	679.34	Free flowing
	Unsealed			85.81	53.46	Agglomeration
180	Sealed	165	30	3616.08	613.28	Free flowing
	Unsealed			81.26	49.71	Agglomeration
210	Sealed	170	30	3573.65	532.56	Free flowing
	Unsealed			75.43	25.42	Agglomeration

EL set =Elongation set, PM set =Permanent set.

4.7.1.1 Physical-Chemical Analysis

From Table 4.8, crosslinkable compound pellet became agglomerate after 24 hours of storage in the unseal aluminium bag package, and was considered the end of its shelf life. However, sealed aluminium bag package compound pellet remain unchanged (free flow) after 210 days of storage.

4.7.1.2 Methanol Wash Test-Chemical Analysis

Shelf life of crosslinkable compound was predicted by the amount of time required for forming the mechanical fines additives and soluble fine additives until it reached equilibrium (permeation time) plus the time that the compound could tolerate the storage condition in an unseal aluminium bag and sealed aluminium bag packaged. Mechanical fines additives content and soluble fine additives content can be calculated by using information from a methanol wash test.

In the sealed aluminium bag, mechanical fine additives content for crosslinkable compound decreased from 16621.29 ppm to 3573.65 ppm over a 210 days period, a slight decreased of 49.7 % in the mechanical fine additives content. This decreased was probably caused by permeation of moisture through the packaging material as shown in Figure 4.20.



Figure 4.20: Permeation of moisture through the packaging material

The increased in the mechanical fine additives content for unsealed aluminium bag was from 16621 to 75.43 ppm over 210 days period, there was 99.5% increment. The mechanical fine additives residue was identified as Bis (tributyltin) oxide as shown in Figure 4.21 and the soluble additives residue identified as 3-chloropropyl trimethoxysilane as shown in Figure 4.22 when tested on the FTIR.

Process degradation by erosion and corrosion eliminated with protection of aluminium bag. The result is due to the increased in the mechanical fine additives content. The stability of silane is affected by chemical reactions, particularly oxidative reaction, which is capable of changing their reactivity and process ability. Silane oxidation process also leads to the deterioration of the compound cross-linking ability.

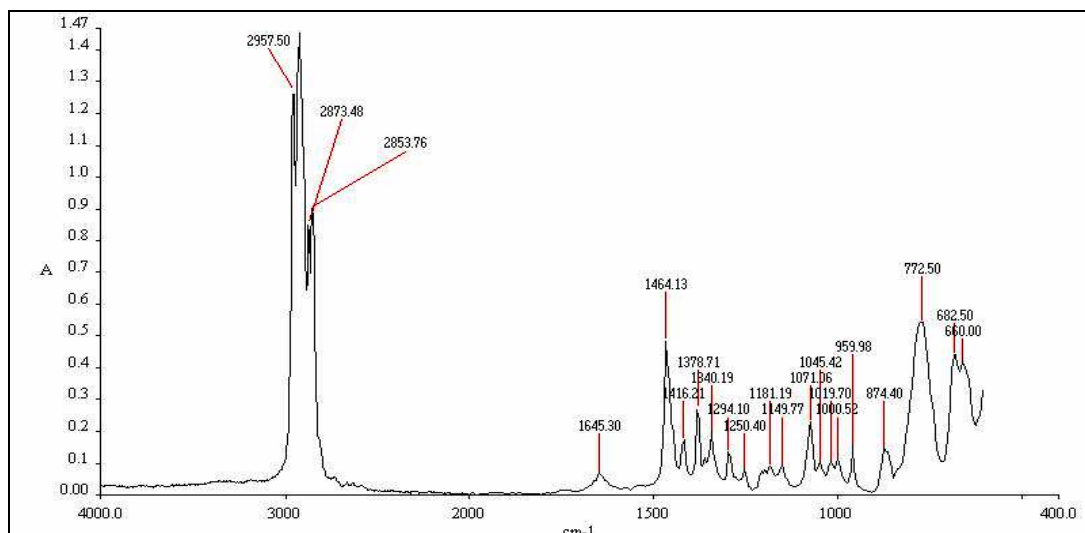

Figure 4.21: FTIR spectrum of Bis (tributyltin) oxide from the mechanical fine additive residue.

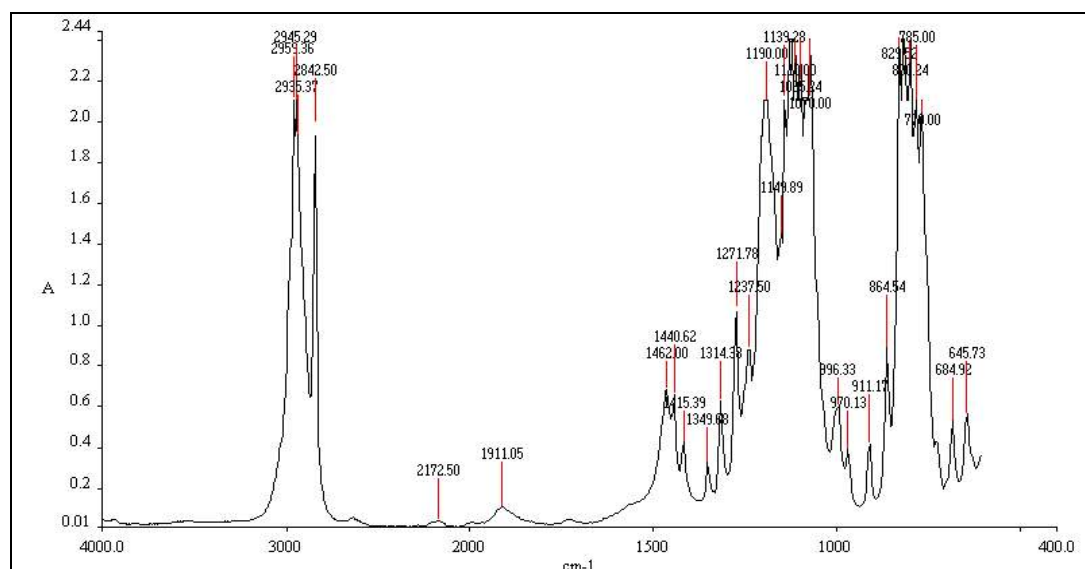

Figure 4.22: FTIR spectrum of 3-chloropropyl trimethoxysilane from the soluble additive residue.

4.7.1.3 Hot Set Test Analysis (IEC 811)

The compound after 210 days of storage in a sealed aluminium bag appeared slightly decrease in crosslinking ability. However, on the processability aspect,

extruding of the bottle was found to be normal (no other plastic flow problems were noticed). The material after six months in a sealed aluminium bag extruding just as well as newly produced compound resulting in sample passes the hot set test. The hot set test showed that crosslinkable compound in a sealed bag gave acceptable results after half year's storage. The hot set properties in sealed bag compound gradually decreased from 50% to 105% during the first 10 days at 25°C, 50 R.H. From day 20 to day 210, no further decline of deterioration in the hot set properties was observed.

For opened bags crosslinkable compound, the hot set test showed a storage life of not more than 24 hours of exposure. The shelf life of silane crosslinkable polyethylene compound was limited to 24 hours due to the deterioration of the vinyl silane chemical. The hot set results relatively unstable during the first 24 hours (varying between 50 and 250 %); sample broke after 48 hours of exposure to atmosphere. From than on and up to 90 days no further changes were detected. It should be noted that, due to the specific chemical properties and components of the different type of formulation, the reactions described above would occur at different rates and degrees of intensity.

Results showed that the methanol wash method offers an efficient estimation of the theoretical shelf life. The hot set test (cross link network) method is to justify shelf life by physical properties. A comparison analysis was developed to assess its relative efficiency. This information is valuable to compound in the crosslinkable compound industry when planning stability studies for shelf life estimation. Analytical data obtained from the storage tests, were used to determine the barrier requirements for dehydrated crosslinkable compound. This method is simple, rapid and economical to optimize the packaging material for dehydrated compound.

4.8 Characterization of Crosslinked HDPE

A characterization of all crosslinked polyethylene formulations which consist of HDPE, VTMO, DCP, DBTL and antioxidant (Irganox 1010) were carried out by a network analysis using solvent swelling and extraction, FTIR, mechanical testing and determination of the melting properties.

4.8.1 Reaction Mechanisms of Thermo Chemical Crosslinking

The effect of antioxidant on the reaction mechanism of chemical crosslinking of polyethylene with dicumyl peroxide (DCP) at high temperatures was investigated by FTIR, gel content and hot set. The antioxidant reacts with the alkyl radicals in polyethylene formed by the thermal decomposition of DCP above 170°C, and disturbs the grafting and crosslinking. A phenolic type antioxidant (Irganox 1010) produced the phenoxy radical by the reaction with alkyl radicals formed in polyethylene.

Most of the free radicals observed during the crosslinking reaction were alkyl, allyl, and phenoxy radicals. In the case of samples AO-0, AO-1, AO-2, AO-3 and AO-4 (refer Table 4.9) with DCP and an antioxidant, the yield of the phenoxy radical increased initially. The alkyl radical was not observed based on reaction mechanism of shown in Figure 4.23. This suggests that the antioxidant reacts with the polyethylene alkyl radical; that is, the antioxidant retards the crosslinking reaction. When the yield of phenoxy radical decreased with time, the yield of the alkyl radical increased. The yield of the alkyl radical then decreased with time. The yield of the allyl radical increased in the same way as the polyethylene sample without antioxidant. Therefore, concluded that the antioxidant affects the formation of the alkyl radical in the early stages. The alkyl and allyl radicals were played the importance role during the crosslinking reaction, and the yield of radicals may be related directly to the number of crosslinking reactions.

Table 4.9: Blend formulation effect of DCP in the presence of antioxidant

Ingredient	Formulations (phr)				
	AO-0	AO-1	AO-2	AO-3	AO-4
High Density Polyethylene. (HB 6200)	100	100	100	100	100
Vinyltrimethoxysilane (VTMO)	1.8	1.8	1.8	1.8	1.8
Dicumyl Peroxide (DCP)	0	0.05	0.1	0.2	0.3
Dibutyltin Dilaurate (DBTL)	0.01	0.01	0.01	0.01	0.01
Antioxidant (Irganox 1010)	0.3	0.3	0.3	0.3	0.3

The reaction mechanisms of polyethylene crosslinking with DCP and antioxidant are listed in Figure 4.23. The DCP initially decomposed to form a cumyloxy radical or a methyl radical and acetophenone. The radicals formed by the DCP thermal decomposition abstracted the hydrogen from the polyethylene very quickly to produce the alkyl radicals. This is because polyethylene molecules surround the DCP molecules. The DCP-decomposed radicals should, therefore, react rapidly with nearby polyethylene. When the antioxidant was added, it seemed to give the hydrogen to alkyl radical quickly to produce the phenoxy radical. When the temperature rises, the yield of the alkyl radical increased significantly. When the alkyl radicals on polyethylene react with other alkyl radicals between polyethylene polymer chains, the crosslinking is formed. If the alkyl radicals react with, the neighboring ones in the same polyethylene chain, a double bond is formed. For the crosslinking or double bond formation, the alkyl radicals must encounter each other either by polyethylene molecules with radical sites moving or by radical sites hopping due to hydrogen abstraction.

The alkyl radicals reacted with the double bond formed by the above reaction to produce allyl radicals. It is known that alkyl radicals convert into allyl radicals and also that the allyl radical is more stable than the alkyl radical from the study of trapped radicals in crystalline polyethylene under the grafting reaction [100].

Although both radicals were formed in the amorphous phase in our case, the allyl radical was rather stable, similar to those in the crystalline phase. The allyl radicals, however, reacted to each other in the encounter to make crosslinking.

Antioxidant is added to prevent oxidation of polyethylene and to improve the heat resistance. However, antioxidant in the polyethylene matrix captured the radicals formed in polyethylene to produce phenoxy radical. Therefore, the antioxidant probably reacts with the polyethylene alkyl radical; that is, antioxidant retards the crosslinking reaction. The main crosslinking of polyethylene was induced by the alkyl radical reactions. As a sub-reaction, some of the alkyl radicals produced double bonds and allyl radicals, and the allyl radicals also contributed to the crosslinking. From the kinetics of radical reactions, the crosslinking rate was strongly dependent on antioxidant concentration and terminated quickly at temperatures above 175 °C. The results obtained in this study can be used to select and control the type and concentration antioxidant in the thermochemical process in polymer crosslinking to optimize the properties of crosslinked polymers.

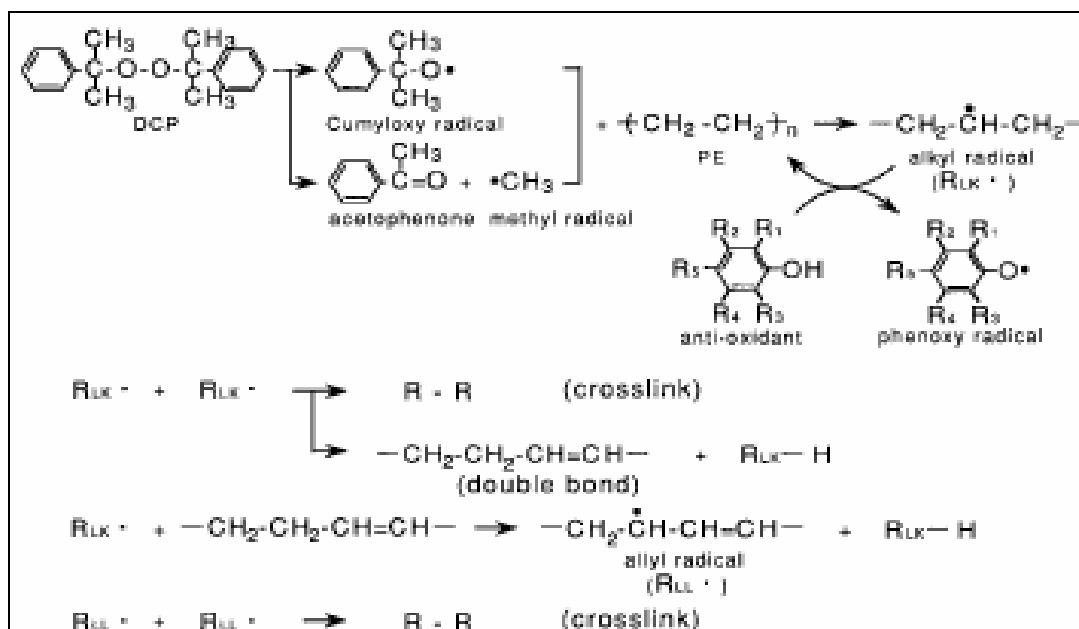

Figure 4.23: Crosslinking reaction scheme for polyethylene with DCP and antioxidant [100].

4.8.2 Characterization of Silane-Grafted HDPE by FTIR

To ensure that silane grafting occurred during the reactive extrusion, Fourier transform infrared (FTIR) spectroscopy was performed on the neat polymer sample and all samples to which 2 phr VTMO was added. Figure 4.24 displays the FTIR results. The vinyltrimethoxy silane group gives characteristic absorptions at 799, 1090, and 1192 cm^{-1} . The 1090 cm^{-1} peak typically has the strongest absorbance and can be used to determine the relative amount of the silane grafting [145,147,152]. In the neat polymer sample and the sample containing VTMO but no DCP, a peak was not observed at 1090 cm^{-1} . From this, it can be concluded that no grafting occurred in these samples, as expected [153]. As the DCP concentration was increased, the 1082 cm^{-1} peak area began to enlarge, as seen in the Figure 4.24, corresponding to an increased in the number of Si-O-C bonds. This leads to the conclusion that increasing DCP concentration (in the presence of VTMO) increases the amount of silane grafting that occurs during extrusion, because the peaks at 1082 and 1181 cm^{-1} are assigned to the functional group Si=OCH₃ [118,149,151,154]. The silane grafting reactions thus have occurred as can be seen from the spectra. The order of the grafting extent was consistent with that of the amount of silane used; that is, the grafting extent for the sample grafting with 2.0-phr silane was the highest and the sample grafting with 1.6-phr silane is the least as shown in Figure 4.25.

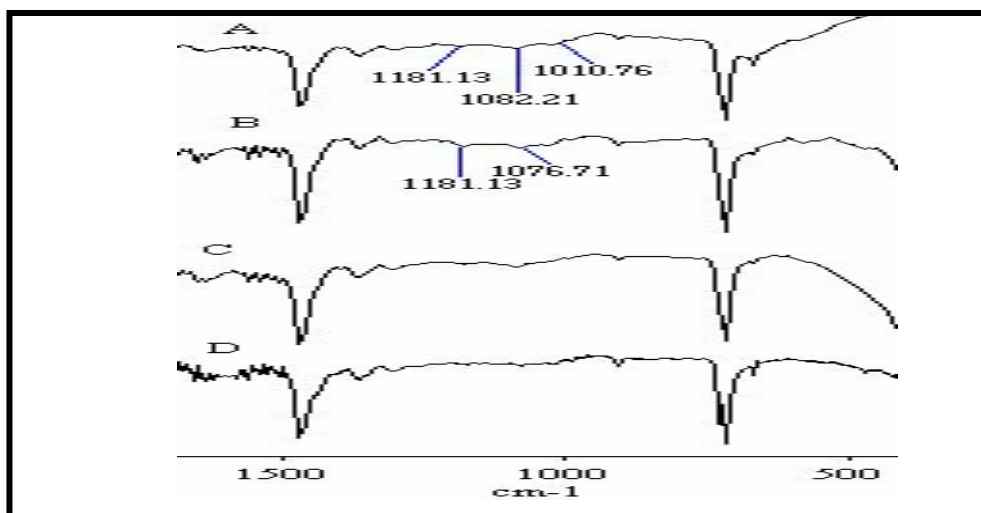

Figure 4.24: FTIR spectra of crosslinked HDPE containing 2.0 phr VTMO and 0.01 phr DBTL with various concentration of DCP (A) 0.5 phr, (B) 0.4 phr, (C) 0.2 phr and (D) 0.1 phr, followed by crosslinking with boiled water for 5 hours.

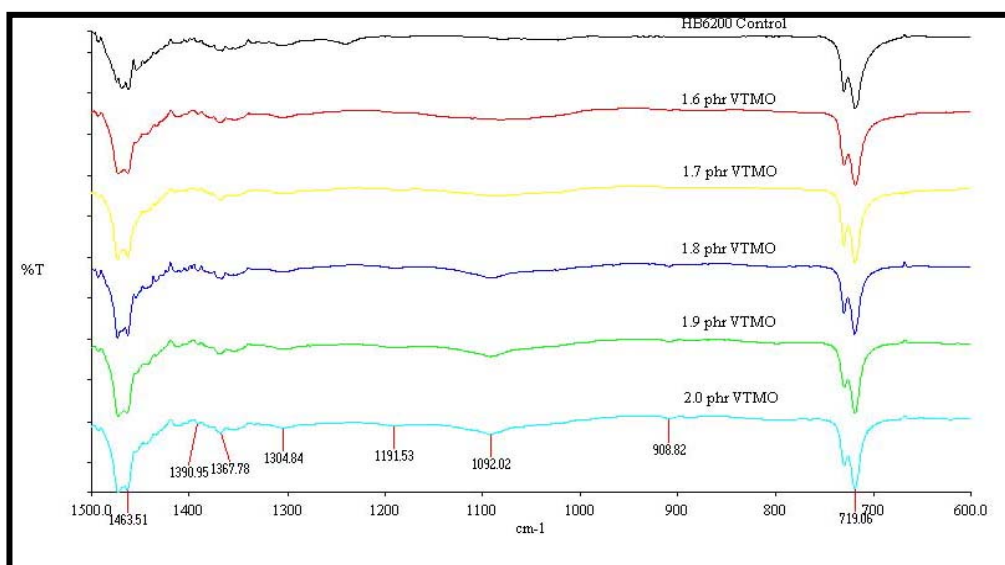

Figure 4.25: FTIR spectra of crosslinked HDPE containing 0.3 phr DCP and 0.01 phr DBTL with various concentration of VTMO (1.6, 1.7, 1.8, 1.9 and 2.0 phr), followed by crosslinking with boiled water for 5 hours.

4.8.3 Hot Set Test-Molecular Structure

The binding of polyethylene molecules in peroxide initiator crosslinked insulation is a linear one. This means that at one crosslinking site two polyethylene molecules are attached together. In the case of silane crosslinking the binding is a three dimensional one. At one crosslinking site about 3 to 4 molecules are attached together. Such three-dimensional interlink structures make movement between molecules even more difficult that if the structure had only been linear. This can be experimentally verified in a test comparing the hot set test against its gel content for various samples of silane and peroxide crosslinked PE. Figure 4.26 shows this relation. It can be noted that for a given gel content (say 70%); the results for the corresponding hot set test elongation are 40% for silane polyfunctional crosslinked polyethylene and 140% for the peroxide initiator PE crosslinked. In others words, for the same number of linked molecules (as indicated by the gel test) the hot set elongation is demonstratively better for the silane polyfunctional crosslinked PE (only 50% elongation) than the peroxide initiator crosslinked PE (120 % elongation).

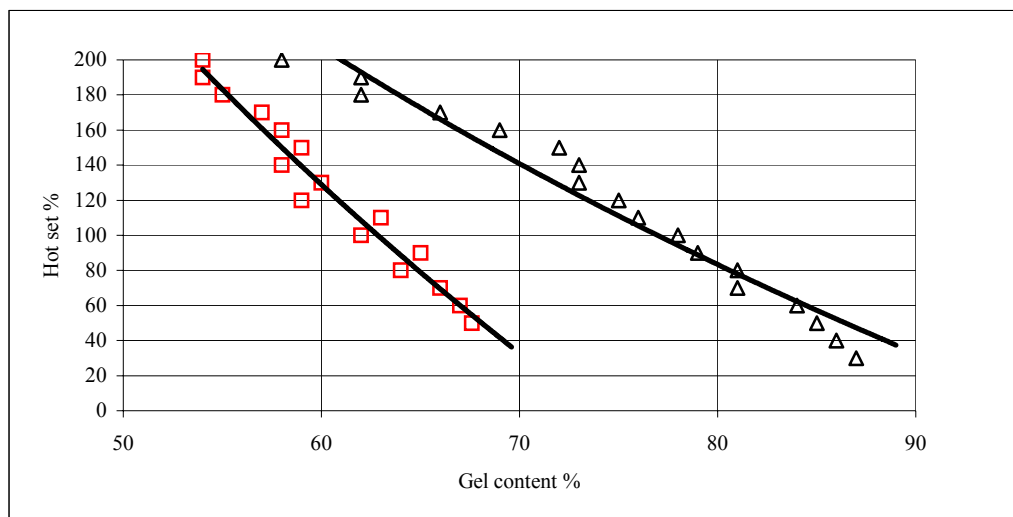

Figure 4.26 : The relationship on the hot set test against its gel content.Δ- Silane polyfunctional crosslinked PE, □- peroxide initiator crosslinked PE.

4.9 Physical Properties of Crosslinked HDPE

4.9.1 Density

The results of density measurements for the crosslinked blow molded HDPE samples are reported in Figure 4.27. The density of the neat HDPE without cross linking was also given as a reference point in comparison with crosslinked samples containing various amounts of vinyl silane and peroxide. From Figure 4.27, the density of crosslinkable HDPE granules decreased by process of the extrusion blow molding due to rearrangement and extra packing of the polymer chains as a result of the imposed pressure. But, with increased in crosslinking, the density of HDPE decreased systematically for all types of the formulation. The densities of all a formulations decreased continuously with the increased of gel content. This behavior can be attributed to the reduction of crystallinity in both series of samples because of network formation thus decreased the free volume. The interlinking of polymer chains by cross-linking restricts the mobility and hence the ordering of the chains. Nevertheless, the network itself corresponds to a denser structure than that of the amorphous phase. Thus, network formation and crystallinity reduction are competitive factors, and as was evident, network formation dominated in all cases, leading to a decreased in density. The changes in gel content showed a behavior similar to that for density. The explanation is essentially the same as that given in connection with changes in density.

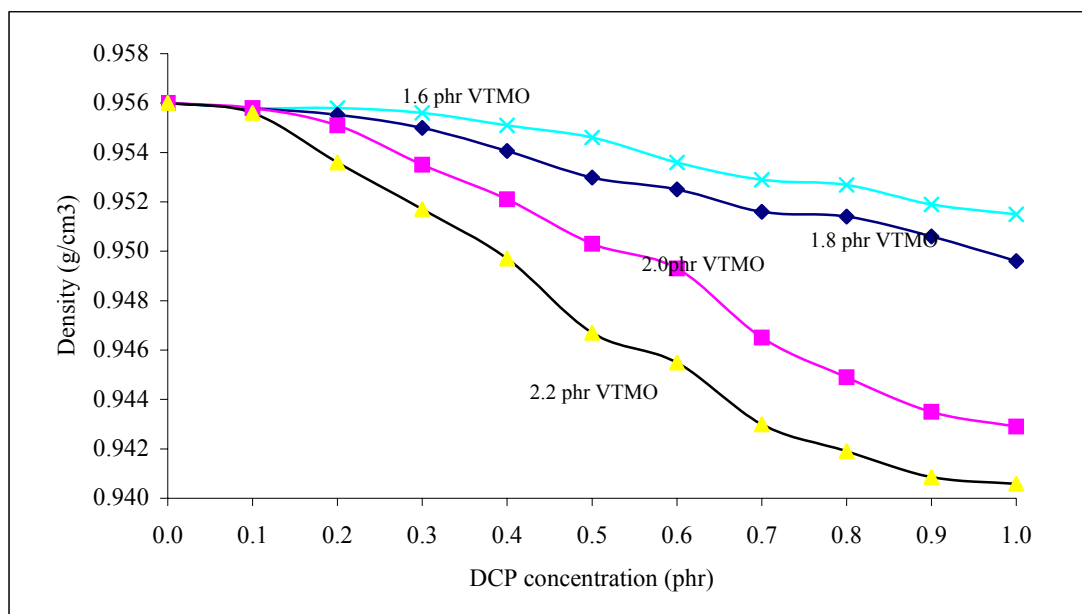

Figure 4.27: Density of various formulations with constant processing condition. (Melt temperature= $175\pm 5^{\circ}\text{C}$)

4.9.2 Thermal Stability -Thermogravimetric Analysis

Thermal stability for the decomposition temperature from TGA analysis improves as expected with crosslinks density as shown in Figure 4.28. TGA curves for the uncrosslinked and crosslinked HDPE samples with various amounts of vinyl silane and peroxide concentration in the designed crosslinkable formulation. All crosslinked HDPE samples did not show a major weight loss up to about 486°C . This behavior was almost identical for all the samples, although there was a slight reduce trend in onset of the thermal decomposition with increased in peroxide content. Since the crosslinking introduced tertiary carbons in the system, which were more prone to thermal decomposition therefore the observed reduce trend was due to increase in number of the tertiary carbon atoms with increased in peroxide content. However, these changes were too small to be considered as a significant effect. This indicated that the thermal stability of the crosslinked HDPE was independent of the degree of crosslinking (gel content). This was also true for the HDPE samples with lower MFI value. Similar results were reported by Krupa et al [24].

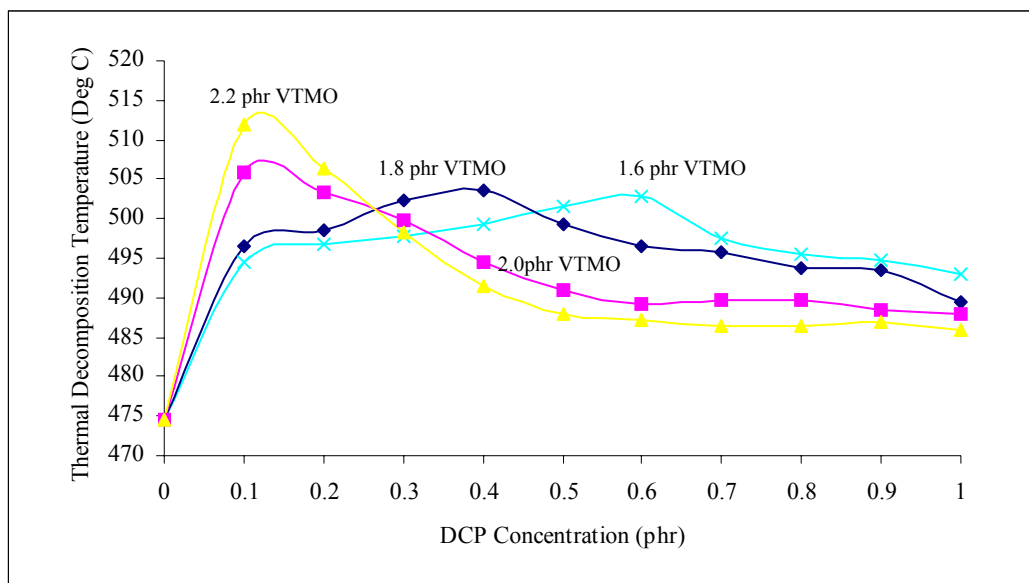

Figure 4.28: Effect of crosslinking on the thermal stability of crosslinked high-density polyethylene

It is clearly seen that the thermal decomposition temperature of crosslinked polyethylene was greatly improved compared with the pure HDPE resin. The degradation temperature of the crosslinked HDPE was higher than that of the pure HDPE. For example, the temperatures of the 10% weight loss for HDPE (curve a) and the crosslinked HDPE (curve b) are 445°C and 475°C, respectively as shown in Figure 4.30. Figure 4.30 also shows that the thermal stability of silane crosslinked HDPE increased slightly with increased of the silane content (curves b, c and d).

Figure 4.29 also shows the decomposition temperatures of crosslinked HDPE with low concentration VTMO crosslinker and higher concentration were 486.50 and 512°C, respectively, which were much higher than 475 °C for neat HDPE as compared to silane-grafted HDPE, the cause for the lowest decomposition temperature for the peroxide initiator crosslinked HDPE which contain higher portion of peroxide was probably due to the leftover of dicumyl peroxide after the grafting reactions performed in the extruder. The leftover of the peroxide resulted in generation of free radicals and subsequent chain scission of the HDPE molecules

during TGA measurements. The cause for the relatively low decomposition temperature for composition (2.2 phr VTMO and 0.5 phr DCP) compared to (2.2 phr VTMO and 0.1 phr DCP) was due to lower concentration of dicumyl peroxide used in the sample formulations. Lower concentration of the peroxide used in the formulations (2 phr VTMO and 0.1 phr DCP) led to less peroxide undergo cross linking with HDPE molecules during the silane grafting reactions and, thus, led to lower decomposition temperature. By-products from DCP initiator, acetophenone, α -methyl styrene, and cumyl alcohol trapped in the sample were released on the surface and generated micro void in samples. These are also another main concern when designing the crosslinkable formulation in term of peroxide initiator concentration and processing parameter such as melt temperature, melt pressure and resident's times.

The effects of the VTMO crosslinker on crosslinked HDPE decomposition temperatures were demonstrated using the following 3 samples (Figure 4.30).

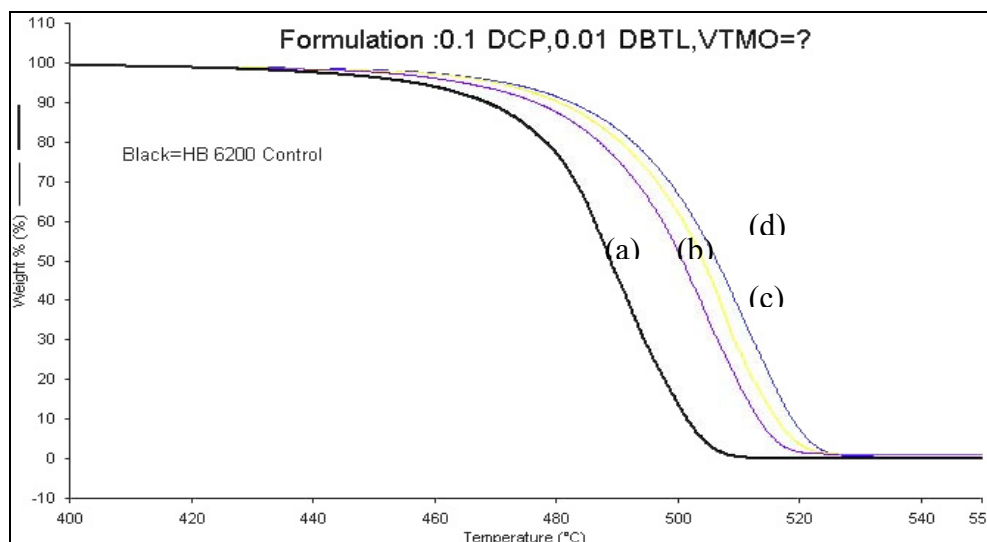

Figure 4.29: TGA thermogram of decomposition temperature of crosslinked HDPE (a) Neat HDPE, (b) 1.6 phr VTMO, (c) 1.7 phr VTMO and (d) 1.8 phr VTMO.

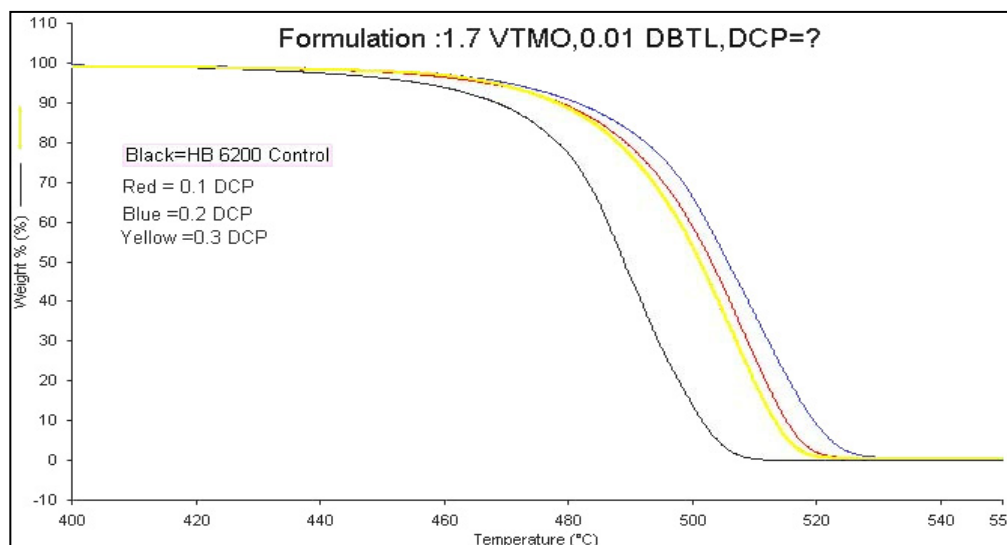

Figure 4.30: TGA thermogram of decomposition temperature of crosslinked HDPE with several of DCP concentration in phr.

One of these samples had the composition of 100 parts of HDPE and 0.01 phr of DBTL with various portion (0.1, 0.2 and 0.3 phr) of DCP. These 3 samples were prepared using an extruder with the same operating temperatures as previously described. The TGA data confirmed that condensation reactions of the silane grafts did not occur during the TGA heating and, thus, the silane grafts were insensitive to heat. The TGA results were consistent with DSC data in terms of thermal stability of the VTMO crosslinker on crosslinked HDPE. TGA data in Figure 4.30 demonstrated that the cause of the increase in the decomposition temperature was due to the silane grafts but not due to the peroxide-induced crosslinking reactions during the silane grafting reactions performed in an extruder.

The results show that the thermal stability of crosslinked HDPE slightly increased with VTMO crosslinker concentration. This is a logical consequence of the thermal stability of the vinylsilane in term of bonds strength. In the silane system the cross-linking reactions form a very stable siloxane bond, Si-O-Si, which has bond strength about 100KJ/mol higher (446 KJ/mol) than the linear peroxide induced C-C crosslink. There are obviously some C-C linkages but these are small in comparison to the Si-O-Si links. Thus, not only are the links polyfunctional, but also the Si-O-Si

bonds forming between polymeric molecules are strong (in terms of bond strength) than the C-C cross-links. Thermal stability of cross-linked HDPE decreases with an increase in peroxide initiator concentration, Figure 4.31. This is a logical consequence of the lower thermal stability of the carbon bonding strength. The free radicals generated on the polyethylene chain results in direct C-C crosslink, which has bond strength of 349 kJ/mol. From the experimental results, the thermal decomposition temperatures of the neat HDPE were 2.5 to 7.9 % lower than cross-linked HDPE base on various formulations. The degradation temperatures were found to increase after silane grafting reaction and cross-linking reactions. The degradation temperature of the crosslinked HDPE was higher than that of neat HDPE, suggesting that the crosslinking reaction of HDPE can raise its upper temperature limit of application.

4.9.3 Melting Behavior-DSC

Differential scanning calorimetric (DSC) was applied to determine the melting peak and specific melting enthalpies (endotherms) of all crosslinkable polyethylene formulation. Two consecutive scans were carried out to minimize the influence of any residual stress in the material due to the specific thermal history. The obtained melting peak temperature as a function of VTMO crosslinker and initial peroxide concentration are shown in Figure 4.31 and of the melting endothermic in Figure 4.32. It is clearly apparent that peroxide initiation crosslinking strongly affects the melting characteristics. A similar behavior was observed for the melting enthalpies. In the case of the vinylsilane as crosslinker it appears, however, that the properties of the crystalline material are hardly influenced by the crosslinking process with the melting peak temperatures remaining basically unchanged.

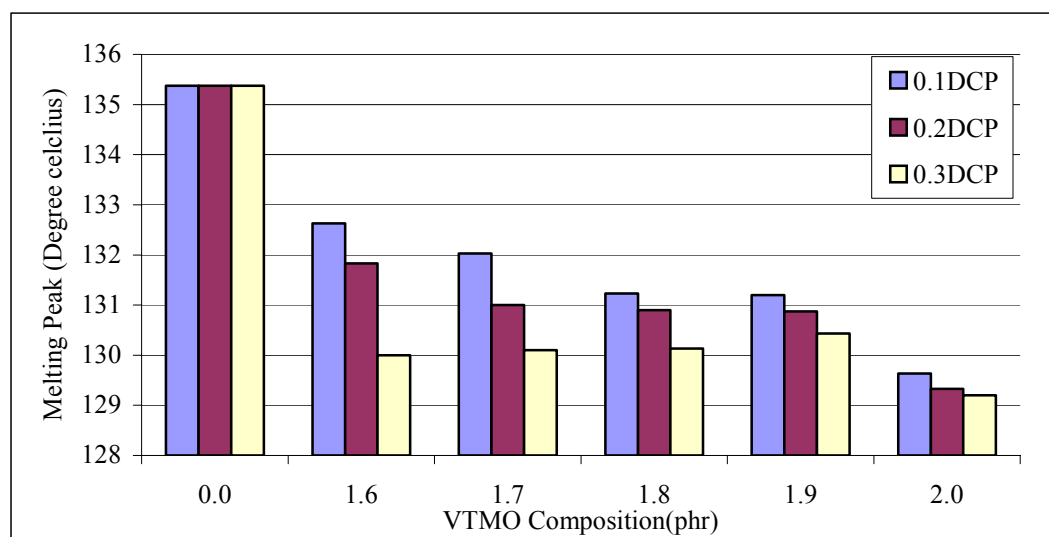

Figure 4.31: DSC thermograms had shown the changes in the melting points of different cross-linked materials formulations with increasing crosslinker concentration. The cross-linked HDPE containing 0.01 phr DBTL with various concentration of VTMO (1.6, 1.7, 1.8, 1.9 and 2.0 phr) and various concentration of DCP (0.1, 0.2 and 0.3 phr), followed by crosslinking with boiled water for 5 hours.

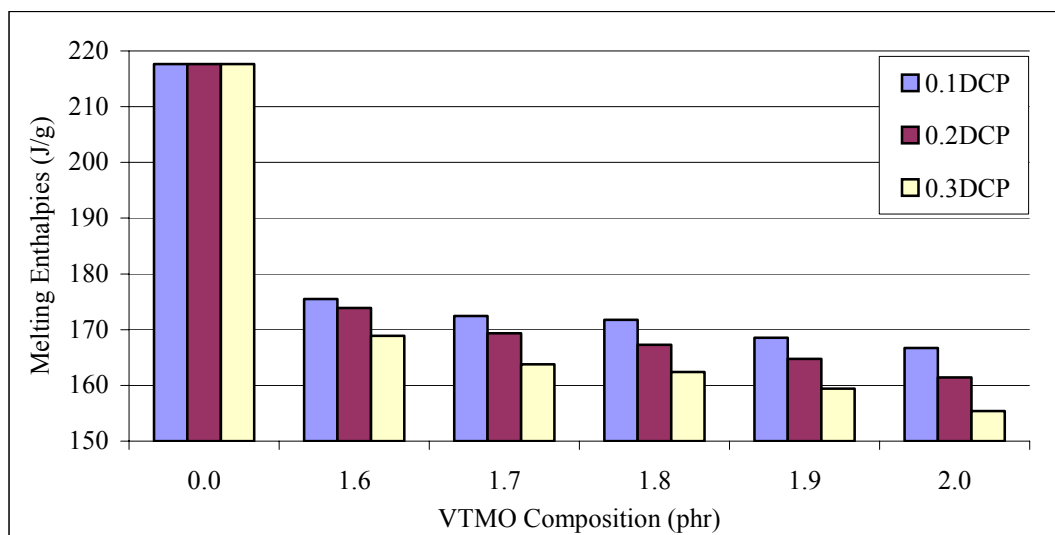

Figure 4.32: Changes in the melting enthalpies (ΔH , J/g) of different crosslinked materials formulations with increasing crosslinker concentration. The crosslinked HDPE containing 0.01 phr DBTL with various concentration of VTMO (1.6, 1.7, 1.8, 1.9 and 2.0 phr) and various concentration of DCP (0.1, 0.2 and 0.3 phr), followed by cross-linking with boiled water for 5 hours.

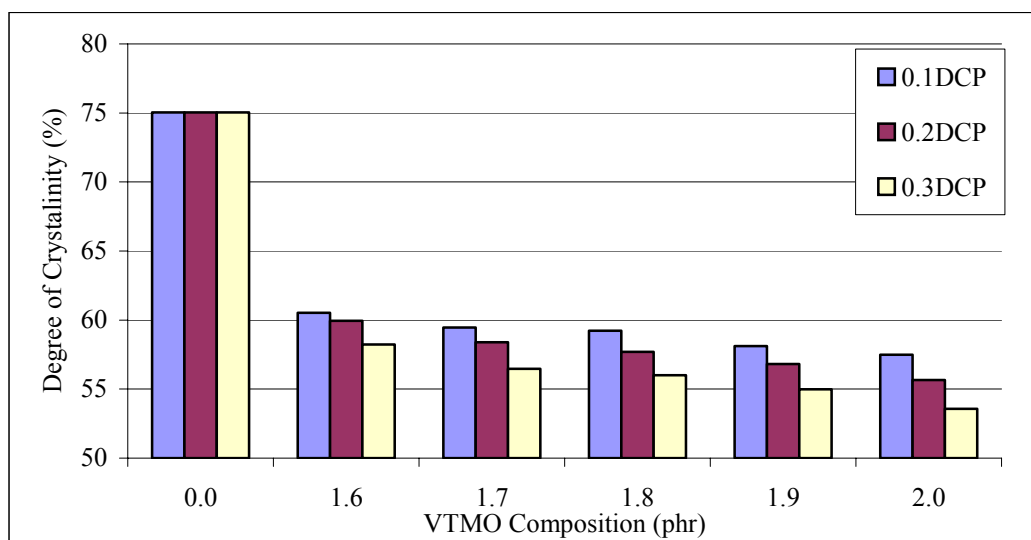

Figure 4.33: Changes in the degree of crystallinity of different cross-linked materials formulations with increasing crosslinker concentration. The cross-linked HDPE containing 0.01 phr DBTL with various concentration of VTMO (1.6, 1.7, 1.8, 1.9 and 2.0 phr) and various concentration of DCP (0.1, 0.2 and 0.3 phr), followed by cross-linking with boiled water for 5 hours.

It is clearly apparent that DCP concentration influenced the melting temperature and enthalpy of the crosslinked polyethylene more than the VTMO crosslinker. Increased peroxide concentration quickly leads to crosslinked materials with lower melting temperature and enthalpy than the original HDPE, which is consistent with the results of previous studies [155,156]. In this case the melting temperature and enthalpy remain nearly constant. The nearly constant melting temperatures and endothermic of the VTMO crosslinker which are generally little higher than for the DCP may be explained by a higher fraction of slightly crosslinked crystalline region. This would correlate with the more homogeneous crosslinking and structural modification in the case of the peroxide crosslinking leading to an overall melting at lower temperatures. It is apparent that the additional of peroxide can easily lead to higher gel contents. VTMO crosslinking has generally lower gel contents but tougher networks (lower solvent uptake factor) for comparable gel contents, which is in agreement with previous studies [9, 10]. The melting enthalpies (ΔH) (Figure 4.33) as well as the degree of crystallite (Figure 4.34) of crosslinked HDPE decreased significantly with increasing the peroxide content up to 0.3 phr but then gradually became constants. The results suggest that 0.3 phr of DCP initiator is the optimum content for crosslinking of HDPE by peroxide initiator.

It is therefore seems as if crosslinking process reduces the crosslinked HDPE crystallinity. Hence, grafting and cross linking probably play the role of defect centres, which impede the folding of macromolecular chains, and thus decreased the sizes of the lamellar crystals as suggested by Lazar [157]. Even a small number of crosslinks reduce the crystallinity of crosslinked HDPE provided that the crosslinking is performed above the melting temperature of the polymer crystallites. The changes in crystallinity of HDPE brought about by crosslinking are reflected in the melting temperature (T_m) [158,159], heat capacity [160] and heat conductivity [161] of polymers.

The reduction of lamellar thickness of crystallites leads to a decrease of melting temperature. On the other hand, the crosslinks stabilize the arrangement of macromolecules which contributes to an increase in melting temperature (T_m).

Actual values of melting temperature (T_m) for a given sample of crosslinked HDPE depend on initial crystallinity of a polymer, temperature and times at which cross linking was conducted, as well as on conditions of crystallization before a measurement. The effect of crosslinking on the heat capacity of HDPE was mediated through the change of crystallinity and reduced mobility of macromolecules. The higher extent of amorphous region in a polymer of a polymer increases the heat capacity, while the reduced mobility led to its decrement on enthalpy; since the heat capacity and enthalpy are related to each other. The crosslinking of HDPE gave rise to a decreased in its crystallinity by interfering with crystal growth.

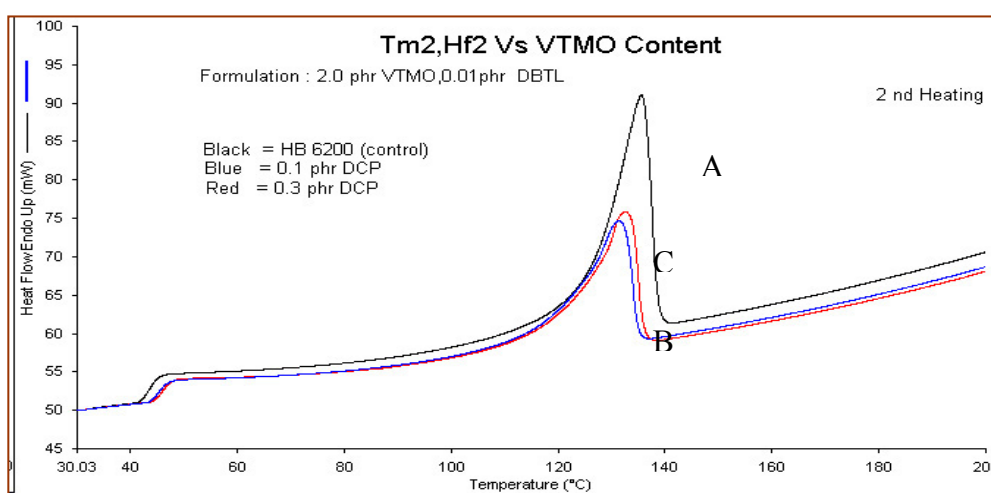

Figure 4.34: DSC thermograms of silane crosslinked HDPE with various initiation peroxide (DCP) concentrations (A) 0.0 phr, (B) 0.1 phr (C) 0.3 phr.

As can be seen in thermograms A to C of Figure 4.34, the peak temperatures for silane grafted crosslinked HDPE was slightly shift to lower values compared with that for virgin HDPE. As shown in Figure 4.34 with the addition of a small amount of DCP initiator to silane crosslinkable formulation, the melting temperature and heat of fusion decreased, which is attributed to the change of the shape of melting peak due to the crosslinked of the polymer bond. However, the melting temperature was maintained when the DCP and VTMO content in the formulation increased. Although the temperature of melting peak (T_m) of the silane crosslinked polyethylene decreased slightly compared with the neat HDPE due to the crosslinked

of the polymer bonding, the widths of the endothermic peaks in Figure 4.35 is, apparently, in the order of virgin HDPE > 0.1 phr > 0.3 phr for silane crosslinkable HDPE formulations. In other words, the heterogeneity of molecular structure of these polymers was increased by the silane grafting crosslinking reactions.

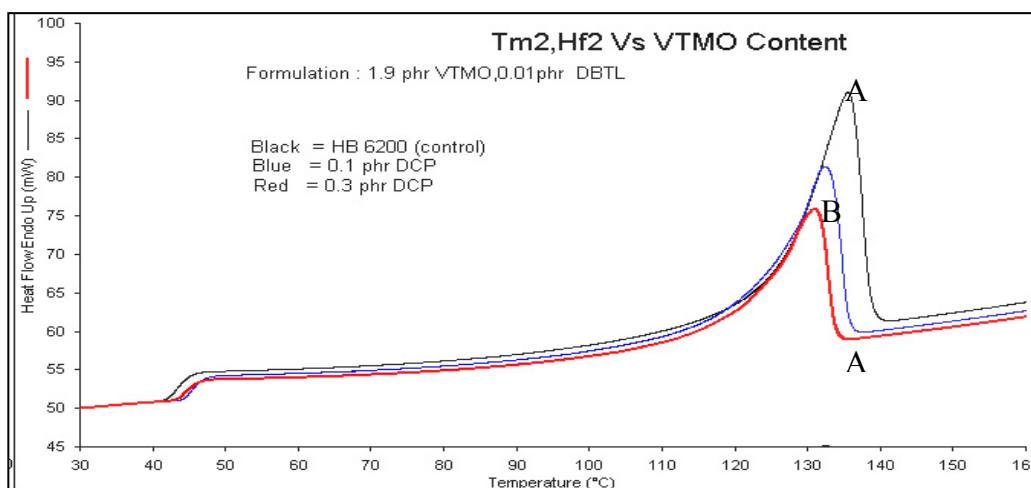

Figure 4.35: DSC melting endothermic and crystallization exothermic for HDPE samples containing (A) 0.0 phr, (B) 0.1 phr, (C) 0.3 phr.

As it is seen with increased of DCP content as per Figure 4.35, both are shift in melting and crystallization temperatures from higher to a lower values. Moreover the related enthalpies of transitions (area under the peak) also decreased with increasing in DCP content. The dependence of melting temperature (T_m) and crystal transition temperature (T_c) and degree of crystallinity (X_c) to the DCP content are shown in Figure 4.35. A decreased in the T_m , T_c and X_c were observed with an increase in DCP peroxide initiator content. This indicates that crosslinking had a direct influence on the crystallization process of crosslinked HDPE. As the crosslinking level increased it hinders the crystallization of HDPE to a much more extent. For example the decreased in melting and crystallization temperatures was about 6.2°C respectively while the degree of crystallinity was decreased by about 21.4%. The melting temperature is related to the, crystal size while the enthalpy of fusion (area under the curve) is related to the total amount of crystallites. Crosslinking causes formation of new chemical bonds between the macromolecular

chain and this hinders the crystal growth. This proof that the crosslinks play the role to defect the centers, impeding the folding of macromolecular chains and thus the crystal size remains small.

4.10 Tensile Properties of Crosslinked HDPE

Mechanical tensile testing of various silane and peroxide crosslinkable polyethylene formulation was carried out to determine the maximum tensile strength and stress at break as well as to assess the general relaxation behavior of the material under mechanical load. The tensile behavior of crosslinked HDPE with various formulations correlated with the gel content is shown in Figure 4.36. The values of the tensile strength, elongation at break and gel content are given in Table 4.10. As the curves indicate, for low values of the gel (up to 10%), the tensile strength increased linearly in either case, and the crosslinked HDPE exhibiting lower values compared to neat HDPE. At higher values of the gel (50% and above), the tensile strength seems to level off in the case of increasing DCP concentration and VTMO. This indicates that the role of short-chain branches in HDPE, which serve to induce interlamellar linking of the crystalline domains via tie molecules [162,163,164].

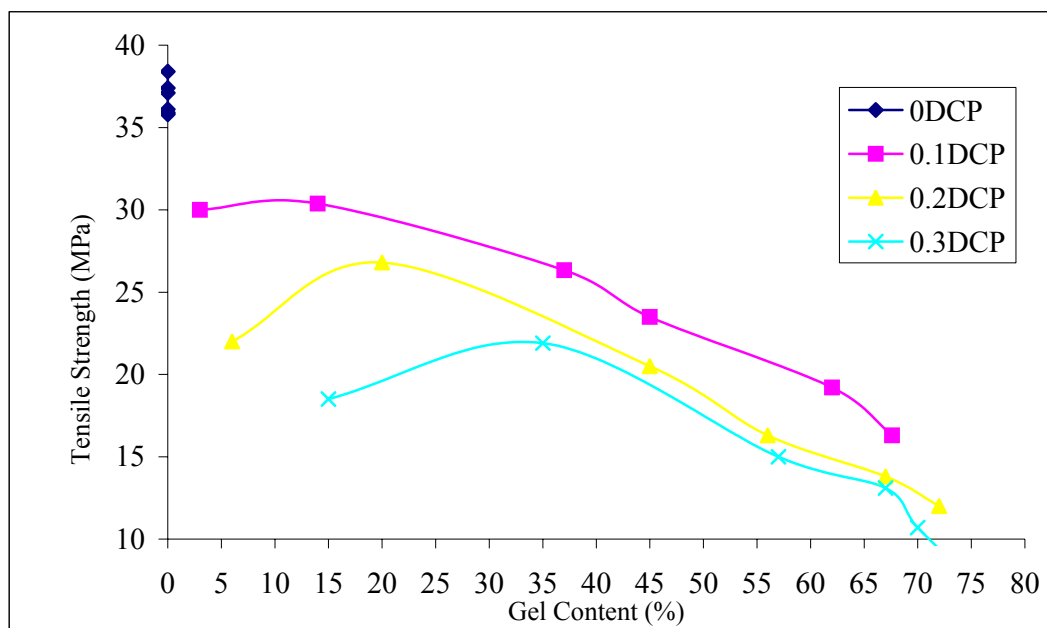

Figure 4.36: Correlation of tensile strength with gel content of crosslinked HDPE

An increased in the crosslinker and peroxide initiator concentration for both chemical (VTMO and DCP) resulted in the reduction of the maximum elongation at break from initially approximately 1000% to 400% at high peroxide (DCP) concentration. The elongation at break of crosslinked HDPE end of varying gel contents is shown in Figure 4.37. The molecular process taking place during the extension of a semi crystalline polymer beyond the yield point is the unfolding of lamellar like folded chain crystals [165,166]. Due to the high crosslink density, mobility of the long-chain molecules was restricted, thus hindering the unfolding process, leading to a decreased in the elongation at break.

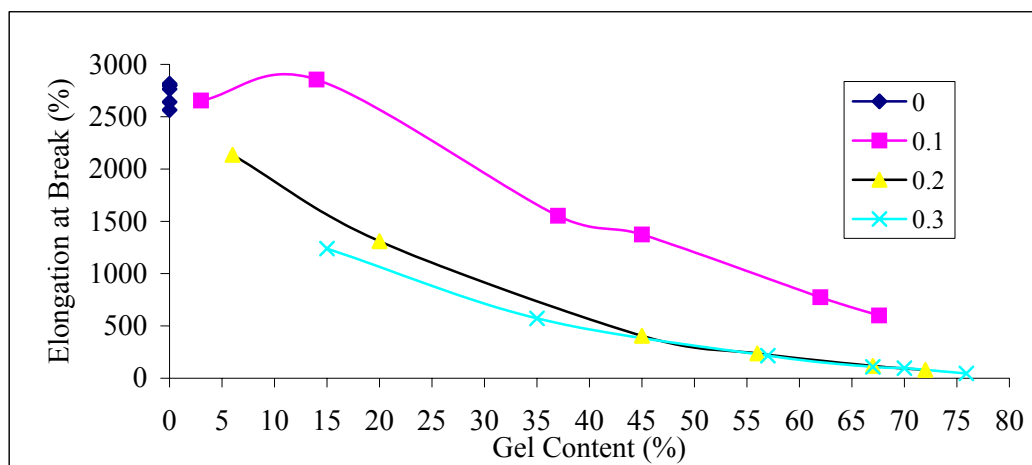

Figure 4.37: Elongation at break versus gel content of crosslinked HDPE.

In the first case the maximum tensile strength changed from initially approximately 30.38 MPa at 0.1 phr DCP to 7-10 MPa at higher peroxide concentrations (0.3 phr). All cross linkable polyethylene formulation samples seemed to display a more constant maximum tensile strength of approximately 15 MPa and above at gel content of 55 % level. A possible explanation for the observed behavior may be a more effective strain hardening during the elongation of the crosslinkable polyethylene formulation. This may be due to a larger fraction of effectively uncrosslinked chains resulting in a higher degree of mobility, flexibility and better plastic flow. It may also be feasible to describe the silane crosslinkable polyethylene formulation as a quasi composite material in which highly crosslinked centers alternate with effectively uncrosslinked regions.

This could provide for the basic and easy relaxation processes to occur in the less cross-linked fraction. In a more homogeneously peroxide initiation of crosslinked HDPE this flexibility may have disappeared and a more limited strain hardening is observed. The generally lower gel content of silane crosslinked HDPE may therefore correlate with the observed mechanical testing results. The effect of the gel content on the tensile strength and elongation at break are shown in Table 4.10. A decrease in tensile strength and elongation at break can be observed, reaching a limiting value for the gel above 50% for those cross linkable formulation and the DCP and VTMO concentration, the values being correspondingly lower for the modified HDPE. Although the heat of fusion variation is not as clearly parallel

with the changing of the sample's crystallinity, decrease in crystalline content leads to the softening of the material and, hence, the decrease the initial modulus and strength.

The sharp decrease of mechanical properties on tensile strength and elongation at break on crosslinked HDPE compares to neat HDPE is due to process modifying of thermoplastics phase to thermoset phase. This means, the plastic is changing its characteristics of soft and ductile to hard and tough. Manufacturing parameter is another major cause which influences the dropped in mechanical strength where by the polymer melt is facing higher internal stress during blow up or molding to the sharp (die swell decrease). During reactive extrusion process, melt flow is decreased due to the grafting process and viscosity of the melt become low. The process parameters such as blow up ratio, blow pressure and mold cooling (frozen in orientation) are another possibility causing the lowering of the mechanical properties.

Table 4.10: The two concentration (DCP and VTMO) effect of gel content and the mechanical properties

Formulations No	VTMO	DCP	DBT L	Tensile Strength	Elongation %	Gel Content
	phr	phr	phr	MPa	%	%
1	0	0.0	0	35.8	2800.0	0.0
2	0	0.1	0.01	30.0	2654.5	3.0
3	0	0.2	0.01	22.0	2136.2	6.0
4	0	0.3	0.01	18.5	1239.4	15.0
5	1.6	0.0	0.01	35.8	2815.0	0.0
6	1.6	0.1	0.01	30.4	2854.0	14.0
7	1.6	0.2	0.01	26.8	1309.9	20.0
8	1.6	0.3	0.01	21.9	572.1	35.0
9	1.7	0.0	0.01	36.1	2800.0	0.0
10	1.7	0.1	0.01	26.3	1553.4	37.0
11	1.7	0.2	0.01	20.5	404.7	45.0
12	1.7	0.3	0.01	15.0	215.6	57.0
13	1.8	0.0	0.01	37.1	2765	0.0
14	1.8	0.1	0.01	23.5	1374.3	45.0
15	1.8	0.2	0.01	16.3	236.6	56.0
16	1.8	0.3	0.01	13.1	108.5	67.0
17	1.9	0.0	0.01	37.4	2641.0	0.0
18	1.9	0.1	0.01	19.2	773.8	62.0
19	1.9	0.2	0.01	13.8	117.6	67.0
20	1.9	0.3	0.01	10.7	96.9	70.0
21	2.0	0.0	0.01	38.4	2564.3	0.0
22	2.0	0.1	0.01	16.3	599.7	67.6
23	2.0	0.2	0.01	12.0	79.6	72.0
24	2.0	0.3	0.01	7.00	46.4	75.9

CHAPTER 5

CONCLUSION AND FUTURE WORKS

5.1 Overall Conclusions

In designing and formulating silane crosslinkable blow molded HDPE compounds with satisfactory physical, thermal and mechanical properties the required components are HDPE grade HB6200, VTMO as the crosslinking agent, DCP as the initiator, DBTL as the catalyst and Irganox 1010 as the antioxidant. The properties and processability of the product depends on the formulation. The concentration of vinyltrimethoxysilane (VTMO) relating to 100 parts of base polymer should be between 1.6 to 2.0 phr. When the amount is less than 1.6 phr, sufficient grafting does not take place. An amount larger than 2.0 phr may cause defective molding and also is economically disadvantageous. The concentration of dicumyl peroxide (DCP) initiator, relating to 100 parts of base polymer should be between 0.1 to 0.5 phr. When the amount is less than 0.1 phr, the silane grafting does not proceed sufficiently. When the amount is larger than 0.5 phr, both the extrusion process-ability and the surface appearance of moldings tend to be poor. The concentration of dibutyltin dilaurate (DBTL-silanol condensation catalyst), relating to 100 parts of base polymer should be between 0.005 to 0.02 phr. Preferably 0.01 phr by weight, based on the total weight of polymers. When the amount is less than 0.005 phr, the crosslinking reaction does not proceed sufficiently. When the amount

is larger than 0.02 phr by weight, local cross-linking proceeds in the extruder at the time of extrusion, resulting in a greatly deteriorated appearance of the product.

The degree of crosslinking of crosslinked HDPE increases with increasing concentration of DCP initiator. It was observed that the gel content increases with an increase in DCP initiator concentration. The degree of crystallinity decreased with an increase in DCP initiator concentration.

The crosslinking speed increases with increasing concentration of DBTL, as demonstrated by cure rate as a function of weight concentration DBTL and cross linking reaction time as a function of temperature and residence time. The degrees of cross-linking are not linearly related to the compositions of the blends.

Thus the DCP and VTMO concentration and cure temperature and durations are the two important factors affecting the cross linking level in crosslinked HDPE. A high cross-linking level can be achieved at high DCP initiator concentration and high cure temperature. As the overall crosslinking density increase, the gel increases, while the sol decrease.

The heterogeneity of molecular structure of the HDPE is increased by the silane grafting and crosslinking reaction. Crystallization temperature of silane crosslinked HDPE become higher resulting from a decrease chain mobility due to grafting and or cross linking compared with neat HDPE. As crosslinking proceeds, the melting temperature of crosslinked HDPE was decreased.

TGA data showed that the decomposition temperature of silane crosslinked HDPE was much higher than that of neat HDPE. It was demonstrated that the cause of increase in the decomposition temperature was due to silane grafts but not due to the peroxide induced crosslinking reaction during the silane grafting reactions

performed in an extruder. Density of cross-linked HDPE was decreased by about 0.02 when compared to virgin non-crosslinked HDPE.

Fourier Transform Infrared (FTIR) Spectroscopy showed that the trimethoxy silane group gave characteristic absorption's at 799, 1090, and 1192 cm^{-1} . The 1090 cm^{-1} peak typically had the strongest absorbency and can be used to determine the relative amount of the silane grafting. In the neat HDPE sample and the sample containing VTMO but no DCP, a peak was not observed at 1090 cm^{-1} . From this, it can be concluded that no grafting occurred in samples containing VTMO only, but grafting only occurred in a presence of VTMO and DCP

The result shown that when HDPE is used as the crosslinkable extrusion blow molding compounds there will always be a consumption of a primary antioxidant by the peroxide initiator, which is necessary to avoid scorch. In order to fulfill existing specifications both for crosslinking and thermo-oxidative ageing a secondary antioxidant has to be introduced. With a critical good balance between the peroxide, a phenol, and sulfur containing antioxidant, particularly in the same chemical moiety (AO-1010) a good additive package for silane crosslink able polyethylene compounds is achieved.

5.2 Future Work

With respect to the various data sets and understanding of how cross-linking take place in silane crosslinkable compound. Some ideas for future works need to be taken up such as:

1. Develop Relationship Between Hot Set and Gel Content

Hot set and gel content characteristics are known to be related to one another, but the fundamental work that analyzes the relationships of them have not been thoroughly studied though hot set is used to measure cure, it may provide misleading data concerning the extent of cross-linking without this basic understanding. Gel content has been measured with solvent extraction, but systematically relationship has not been performed.

2. Modified Extrusion Process

Although some premature crosslinking was measured, curing is designed to begin after the extrusion process. However, extrusion is an operation with a large amount of available heat, and moisture can be included under proper conditions. An investigation into how moisture can be incorporated into parts earlier, at deeper positions would be of value. Rotational molding may be an option for this.

3. Uniform Graft and Avoid Scorch in Silane Crosslinkable Compound.

The main problems are how to obtain uniform grafting and avoid scorch (pre-crosslinking) phenomenon of compound during extrusion blow molding process and how to increase grafting reaction speed in the compound during reactive extrusion .The main problem is how to improve manufacturing performance especially in declining load of extruder and increasing capacity as well as products of neat HDPE.

REFERENCES

- 1 Cornelia, Vasile and Raymond .B. Seymour. *Handbook of Polyolefin's*. New York.: Marcel Dekker.1993
- 2 Gowariker, V.R, N.V. Viswanathan and J. Sreedhar. *Polymer Science*.7th.ed. Bangalore.: New Delhi Publisher.1993
- 3 Ulrich, H. *Introduction to Industrial Polymer*.2nd.ed.Munich.: Hanser.1993
- 4 John Brydson. *Plastics Material*. 7th.ed.Oxford.: Butterworth-Heinemann.1999
- 5 Tsuneharu Mori. *Process For Producing Silane Crosslinked Polyolefin*. U.S. Patent 5,756,582.1998.
- 6 Tsuneharu Mori. *Process For Producing Flame-Retardant, Silane-Crosslinked Polyolefin*.U.S. Patent 6,107,413. 2000
- 7 Yeong-Tarng Shieh and Te-Hui Tsai. Silane Grafting Reactions of Low Density Polyethylene. *Journal of Applied Polymer Science*.1998. Vol(69): 255-261.

- 8 Yeong-Tarng Shieh and Chih-Ming Liu. Silane Grafting Reactions of LDPE, HDPE and LLDPE. *Journal of Applied Polymer Science*. 1999. Vol(4): 3404-3411.
- 9 Yeong-Tarng Shieh and Kuo-I Hsiao. Thermal Properties of Silane Grafted Water-Crosslinked Polyethylene. *Journal of Applied Polymer Science*. 1998. Vol(70):1075-1082.
- 10 Seong Ok Han, Dong Won Lee and Oc Hee Han. Thermal Degradation of Crosslinked High Density Polyethylene. *Polymer Degradation and Stability*. 1999. Vol(63): 237-243.
- 11 Yeong-Tarng Shieh, Hui-Chun Chuang, Chih-Ming Liu. Water Crosslinking Reactions of Silane Grafted Polyolefin Blends. *Journal of Applied Polymer Science*. 2001. Vol(81): 1799-1807.
- 12 Yeong-Tarng Shieh and Hui-Chun Chuang. DSC and DMA Studies on Silane Grafted and Water Crosslinked LDPE/LLDPE Blends. *Journal of Applied Polymer Science*. 2001. Vol(81):1808-1816.
- 13 Suresh Kumar and M.V.Pandya. Thermally Recoverable Crosslinked Polyethylene. *Journal of Applied Polymer Science*. 1997. Vol (64):823-829.
- 14 MA.Patricia Muñoz P, Márcio D.Vargas, Moisés M. Werlang. High Density Polyethylene Modified by Polydimethylsiloxane. *Journal of Applied Polymer Science*. 2001. Vol(82): 3460-3467.
- 15 Tae-Kyu Kang and Chang-Sik Ha. Effect of Processing Variables on The Crosslinking of HDPE By Peroxide. *Polymer Testing*. 1999. Vol(19):773-783

- 16 John Murphy. *Additives For Plastics Handbook*. Oxford: Elsevier Advanced Technology. 1996
- 17 Julie A.McCormick, Josep R.Royer, C.Robin Hwang and Saad A.Khan . Tailored Rheology of a Metallocene Polyolefin Through Silane Grafting and Subsequent Silane Crosslinking. *Journal of Applied Polymer Science Part B, Polymer Physics*. 2000.Vol(38): 2468-2479.
- 18 H.Huang.H. H.Lu, N.C.Liu. Influence of Grating Formulations and Extrusion Conditions on Properties of Silane-Grafted Polypropylenes. *Journal of Applied Polymer Science*. 2000.Vol(78):1233-1238.
- 19 Takanori Yamazaki ,Tadao Seguchi. ESR Study On Chemical Crosslinking Reaction Mechanisms of Polyethylene Using a Chemical Agent. *Journal of Applied Polymer Science Part Polymer Chemistry*. 1997. Vol(35): 279-284.
- 20 Daniel Abraham, K.E.George and D.Joseph Francis. Structure-Property-Processing Relationships in Chemically Modified LDPE and LDPE/LLDPE Blend. *Journal of Applied Polymer Science*. 1998. Vol(67): 789-797.
- 21 Smedberg.A, T.Hjertberg and B.Gustafsson. Crosslinking Reaction in an Unsaturated Low Density Polyethylene. *Polymer*. 1997.Vol (38): No 16:127-4138.
- 22 Miyashita.Y and H.Kato. CrossLinking Reaction of LDPE and The Behavior of Decomposition Products From Crosslinking Agents. *IEEE Transactions on Dielectrics and Electrical Insulation*. 1988.259-262.
- 23 Wang.Z, Chan. C.M, Zhu. S.H and Shen.J. Compatibilization of Polystyrene and Low Density Polyethylene Blends By Two-Step Crosslinking Process. 1998.Vol(39).6801-6806.

- 24 Krupa,I and A.S.Luyt .Mechanical Properties of Uncrosslinked and Crosslinked Linear Low-Density Polyethylene /Wax Blends. *Journal of Applied Polymer Science*. 2001.Vol (81): 973-980.
- 25 Bremner,Tim,Rudin and Alfred. Peroxide Modification of Linear Low-Density Polyethylene: A Comparison of Dialkyl Peroxide. *Journal of Applied Polymer Science*.1993.Vol (49): 785-798.
- 26 Penfold, et al. *Silane Crosslinkable, Substantially Linear Ethylene Polymers and Their Uses*. U.S. Patent 5,824,718. 1998.
- 27 Sajkiewicz, P, Phillips P.J. Peroxide Crosslinking of Linear Low-Density Polyethylene's with Homogeneous Distribution of Short Chain Branching. *Journal of Applied Polymer Science. Part A: Polymer Chemistry*.1995.Vol (33):853-862.
- 28 Sajkiewicz,P, Phillips P.J.Changes in Sol Fraction During Peroxide Crosslinking of Linear Low-Density Polyethylenes With Homogeneous Distribution of Short Chain Branching. *Journal of Applied Polymer Science. Part A: Polymer Chemistry*. 1995.Vol (33):949-955.
- 29 Bremner, Tim, Rudin and Alfred. Effect of Antioxidant on Peroxide Modification of LLDPE. *Journal of Applied Polymer Science*. 1995.Vol (57): 271-286.
- 30 Marly G .Lachtermacher and Alfred Rudin. Reactive Processing of LLDPE in Co rotating No intermeshing Twin-Screw Extruder .III. Methods of Peroxide Addition. *Journal of Applied Polymer Science*. 1998.Vol (59): 1775-1785.

- 31 Sheela Kumari Isac and K.E.George .Reactive Processing of Polyethylene on a Single Screw Extruder. *Journal of Applied Polymer Science*. 2001.Vol(81): 2545-2549.
- 32 Masayuki Yamaguchi and Ken-Ichi Suzuki. Rheological Properties of Linear and Crosslinked Polymer Blends: Relation Between Crosslink Density and Enhancement of Elongational Viscosity. *Journal of Applied Polymer Science Part B, Polymer Physics*. 2001.Vol (39): 228-235.
- 33 Stuart A.Nield, Costas Tzoganakis and Hector M.Budman. Chemical Modification of Low Density Polyethylene Through Reactive Extrusion: Part I : Process Development and Product Characterization. *Advances in Polymer Technology*. 2000.Vol (19):237-248.
- 34 Ho-Gab Jeong and Ki-Jun Lee. Effect of Discontinuous Phase Size on Physical Properties of LLDPE / PP Blends Obtained in The Presence of Peroxide. *Journal of Advances in Polymer Technology* . 1999.Vol (18): 43-51.
- 35 Lachtermacher, Marly G,Bremner,Rudin and Alfred. Reactive Processing of LLDPE in Co rotating Intermeshing Twin-Screw extruder .II. Effect of Peroxide Treatment on Processability. *Journal of Applied Polymer Science*. 1995. Vol (58): 2433-2449.
- 36 C.Rosales,R.Perera,J.Gonzalez and etd. Grafting of Polyethylene By Reactive Extrusion. II. Influence on Rheological and Thermal Properties. *Journal of Applied Polymer Science*. 1999. Vol (73): 2549-2567.
- 37 American Society for Testing and Material. *Specification for Crosslinked Polyolefin Heat Shrinkable Tubing for Electrical Insulation*. Philadelphia, D3149. 1995

- 38 American Society for Testing and Material. *Standard Specification for Crosslinked Polyethylene (PEX) Tubing*. Philadelphia, F 876. 1993
- 39 American Society for Testing and Material. *Standard Specification for Crosslinked Polyethylene (PEX) Tubing*. Philadelphia, F 877. 1993
- 40 American Society for Testing and Material. *Test Method For Crosslinked Insulations and Jacket for Wire and Cable*. Philadelphia, D470.1993
- 41 American Society for Testing and Material. *Standard Specification For Crosslinked Polyethylene Insulation Wire and Cable rated 2001 to 35000V*. Philadelphia, D2656. 1995
- 42 GE Plastic. *Design Guide. Release 05*. U.S.A: Trade Brochure.1997.
- 43 The Plastics and Rubber Institute. *Design Factor for Unreinforced Thermoplastics Product With Specific Reference To Pipes*. London: The Plastics and Rubber Institute.1976
- 44 Hoechst AG. *Hoechst Plastics Pipes*. Germany: Brochure No. HKR 111e-8122.1982.
- 45 Chemical Market Reporter. *Polyethylene*. United States: Reed Business Information. 2003.
- 46 Titan Polyethylene (M) Sdn Bhd. *Product Catalogue*. Malaysia: Trade Brochure.1997.
- 47 George W. Knight. Polyethylene. In : Charles B. Arends. *Polymer Toughening*. New York: Marcel Dekker,Inc.189-235; 1996

- 48 Driscopipe. *Marlex Polyethylene Properties and Processing*. New York: Technical Note, #26, PD TN-26. 1996.
- 49 Driscopipe. *Molecular Weight And Molecular Weight Distribution*. New York: Technical Note, #25, PD TN-25.1996.
- 50 Plastics Pipe Institute. *Engineering Properties of Polyethylene*. Washington D.C: Technical Report. 2001
- 51 Anthony Barlow. The Chemistry of Polyethylene Insulation. *IEEE Electrical Insulation Magazine*.1991. Vol (7): 1.
- 52 American Society for Testing and Material. *Standard Specification For Polyethylene Plastics Molding and Extrusion Materials*. Philadelphia, D 1248. 1989
- 53 Juris I.Apse. Polyethylene Resins For Geomembrane applications. In: R.M.Koerner. *Durability and Aging of Geosynthetics*. London: Elsevier Applied Science.159-176; 1989.
- 54 Crawford.R. J. *Rotational Moulding of Plastics*. New York.: John Wiley & Sons Inc. 1992
- 55 Crawford.R. J. *Report 71.Rotational Molding*. United Kingdom.: Rapra Technology Limited. 1993.
- 56 Kenneth J.Gillett and Michael M.Suba. *Electrical Wire Handbook*. Connecticut.: The wire association International Inc. 1983.
- 57 Elf Atochems.S.A. *Extrusion Blow Moulding: Faults, Cause, Remedies*. France: Technical Guide. 1999

- 58 D.C.Wright. *Environmental Stress Cracking of Plastics*. United Kingdom: Rapra Technology Ltd. 1996
- 59 Alfonsius B.Ariawan, Savvas G, Shivendra K and Henry Hay. Effects of Molecular Structure on the Rheology and Processability of Blow-Molding High-Density Polyethylene Resins. *Journal of Advances In Polymer Technology*. 2001. Vol (20): 1-13.
- 60 Lustinger. Eighth Plastic Pipe Symposium Proceedings, November 15-17, 1983, p. 54.
- 61 BP Solvay Polyethylene North America. *Overview of Crosslinked Polyethylene (PEX) Technologies*. Texas: Technical Publication. 2001
- 62 American Society for Testing and Material. *Standard Test Method for Determination of Gel Content and Swell Ratio of Crosslinked Ethylene Plastics*. Philadelphia, D2765. 1995.
- 63 American Society for Testing and Material. *Standard Test Method for Obtaining Hydrostatic Design Basic For Thermoplastic Pipe Materials*. Philadelphia, D2837. 1998.
- 64 The Plastic Pipe Institute Inc. *PPI TR-3: Policies and Procedures for Developing Hydrostatic Design Bases and Minimum Recommended Hydrostatic Design Stresses for Thermoplastic Piping Materials*. Washington D.C.: The Plastic Pipe Institute Inc. 1999
- 65 The Plastic Pipe Institute Inc. *PPI TN-17: Crosslinked Polyethylene (PEX) Tubing*. Washington D.C.: The Plastic Pipe Institute Inc. 1999

- 66 Borealis A.S. *BorPEX™ and PP-R Pipes For Hot & Cold Water Systems*. Denmark: Technical Publication. 2001.
- 67 Shaban. A.M and N.Kinawy. Crosslinking Rate Dependence on The Thickness of High Density Polyethylene Sheets After Gamma-Ray Irradiation In The Presence of Air. *Polymer*. 1995. Vol (36): 4767-4770.
- 68 Borealis A.S. *Borealis Polyolefin Grade For Industrial & Chemical Use*. Denmark. Technical Publication. 2000.
- 69 Klaus Kircher. *Chemical Reactions in Plastics Processing*. New York: Hanser Publishers. 1987
- 70 Akzo Nobel Chemical. *Crosslinking Peroxide and Coagents*. Germany. Technical Notes. 2000.
- 71 Y.Miyashita and H.Kato. Crosslinking Reaction of LDPE and The Behavior of Decomposition Products From Crosslinking Agents. *IEEE Transactions on Dielectrics and Electrical Insulation*. 1988.Vol (2): 259-262.
- 72 Izumi Ishikawa ,Shoichiro Nakamura and Saeri Utsunomiya. The Research of Peroxide Decomposition in XLPE Cables. *IEEE Transactions on Dielectrics and Electrical Insulation*. 1996. Vol (3): 506-511.
- 73 B.Thorburn. Crosslinking Techniques For Electrical Jacketing Materials. ANTEC. May 15-20,1994. San Francisco: Society of Plastic Engineering .1994.1379-1385.
- 74 “Sioplas”(U.S. Patent 3,646,155).
- 75 “Monosil”(U.S. Patent 4,117,195).

- 76 Borealis A.S. *Visico/Ambicat. The Lowest Cost and Highest Quality Solution For Low Voltage Cables*. Denmark. Technical Notes. 2000.
- 77 Schombourg. *Silane, Free Radical Generator, Amine Blends For Crosslinking of Olefin Polymers*. U.S Patent 5,981,674. 1999.
- 78 Gächter.R and H.Miüller. *Plastics Additives Handbook*. 4th.ed. Munich Viena.: Hanser Publishers. 1993
- 79 Crompton Corporation. *Silquest[®] Silanes Recommended For Use In Polyolefin Systems*. Germany. Technical Notes. 2002.
- 80 Crompton Corporation. *Silquest[®] A-171 Silane. Version 95*. Germany. Specification. 1996.
- 81 Degussa Hüls AG.*DYNASYLAN[®] VTMO. Version 9*. Germany. Specification.1994.
- 82 Shin-Etsu Chemical Co. Ltd. *Shin-Etsu Silicone Carbon Functional Silane KBM-1003*.Version 95.Japan.Specification.1995.
- 83 Atofina Chemical Inc. *Organic Peroxides For Rubber Crosslinking Including New Peroxide Curing Systems*. U.S.A. Technical Data. 1994.
- 84 Pt. Nof Chemical Industries. *PERCUMYL D*. Indonesia. Technical Product Specification. 2001.
- 85 Pesetskii S.S, B.Jurkowski, Y.M.Krivoguz, and K.Kelar. Free Radical Grafting of Itaconic Acid onto LDPE By Reactive Extrusion: 1.Effect of Initiator Solubility. *Polymer*. 2001. Vol (42): 469-475.

- 86 Premamoy Ghosh, Debaprasad and Amit Charrabarti. Reactive Melt Processing of Polyethylene: Effect of Peroxide Action on Polymer Structure, Melt Rheology and Relaxation Behavior. *Polymer*. 1997. Vol (38): 6175-6180.
- 87 Atofina Chemical Inc. *Organic Peroxides*. U.S.A: Technical Data. 2001.
- 88 Akzo Nobel Polymer Chemical. *Perkadox[®] BC-FF*. Netherlands: Product Specification. 2001.
- 89 T.H GOLDSCHNIDT AG. *TEGOKAT[®] 218, Version 9*. Germany: Product Specification. 1996.
- 90 Magnus Palmöf and Thomas Hjertberg. Catalysis of The Crosslinking Reactions of Ethylene Vinyl Silane Copolymers Using Carboxylic Acids and DBTDL. *Journal of Applied Polymer Science*. 1999. Vol (72). 521-528.
- 91 Cree, et al. *Crosslinkable Bimodal Polyolefin Compositions*. U.S Patent 5,852,116. 1998.
- 92 Ciba Specialty Chemical Inc. *Irganox 1010, Version 9*. Switzerland: Product Specification. 2001.
- 93 Ciba Specialty Chemical Inc. *Additives for Polyolefin's-Key Products Selection Guide*. Switzerland: Technical Guide. 1999.
- 94 Ciba Specialty Chemical Inc. *Processing and Long Term -Term Thermal Stabilization of Polyolefin's*. Switzerland: Technical Guide. 1992
- 95 F.Danekas. *Silane Crosslinking*. Singapore.: Plexchem Technologies. 1998

- 96 Mtshali T. N, I. Krupa and A. S. Luyt. The Effect of Crosslinking on The Thermal Properties of LDPE/Wax Blends. *Thermochimica Acta*. 2001. Vol (380): Issue 1. 47-54.
- 97 Krupa. I and A. S. Luyt. Thermal Properties of Uncrosslinked and Cross-linked LLDPE/Wax Blends. *Polymer Degradation and Stability*. 2000. Vol (70): Issue 1. 111-117.
- 98 Mallégol. J, D. J. Carlsson and L. Deschênes. A Comparison of Phenolic Antioxidant Performance in HDPE at 32-80°C. *Polymer Degradation and Stability*. 2001. Vol (73): 259-267.
- 99 Charlesby. A. Molecular Weight Changes and Network Formation By Scission and Crosslinking. In: Güven. O. Crosslinking and Scission in Polymer. London: Kluwer Academic Publishers.1-13. 2003.
- 100 Takanori Tamazaki and Tadao Seguchi . ESR Study on Chemical Crosslinking Reaction Mechanisms of Polyethylene Using a Chemical Agent-II. The Effect of Phenolic Antioxidants. *Journal of Applied Polymer Science: Polymer Chemistry*. 1997. Vol (35): 2431-2439.
- 101 Takanori Tamazaki and Tadao Seguchi. ESR Study on Chemical Crosslinking Reaction Mechanisms of Polyethylene Using a Chemical Agent-III. The Effect of Amine Type Antioxidants. *Journal of Applied Polymer Science: Polymer Chemistry*. 1999. Vol (37): 349-356.
- 102 Takanori Tamazaki and Tadao Seguchi. ESR Study on Chemical Crosslinking Reactions of Polyethylene Using a Chemical Agent .IV. Effect of Sulfur and Phosphorous-Type Antioxidants". *Journal of Applied Polymer Science: Polymer Chemistry*. 2000. Vol (38): 3092-3099.

- 103 Takanori Tamazaki and Tadao Seguchi. ESR Study on Chemical Crosslinking Reaction Mechanisms of Polyethylene Using a Chemical Agent. *Journal of Applied Polymer Science: Polymer Chemistry*. 2001. Vol (39): 2151-2156.
- 104 Donald V. Rosato and Dominick V. Rosato. *Blow Molding Handbook*. New York.: Hanser Publishers. 1989
- 105 Society of the plastics Industry. *Plastic Engineering Handbook of the Plastics Industry*. 5th.ed. New York.: SPE. 1991
- 106 American Society for Testing and Material. *Standard Specification For Crosslinkable Ethylene Plastics*. Philadelphia, D 2647. 1994
- 107 American Society for Testing and Material. *Standard Test Method For Melt Flow Rates of Thermoplastics By Extrusion Plastometer*. Philadelphia, D 1238. 2000
- 108 American Society for Testing and Material. *Standard Test Method For Tensile Properties of Plastics*. Philadelphia, D 638M. 1997
- 109 American Society for Testing and Material (1996). "Standard Practical For Conditioning Plastics For Testing ." Philadelphia (D 618).
- 110 American Society for Testing and Material (1994). "Standard Practical For Heat Aging of Oxidative Degradable Plastics." Philadelphia (D 5510).
- 111 American Society for Testing and Material (1992). "Standard Practical For Heat Aging of Plastics Without Load." Philadelphia (D 3045).

- 112 International Electro technical Commission (1989). "Common Test Methods For Insulating and Sheathing Materials of Electric Cables. Part 1: Methods For General Application." New York. (IEC 811).
- 113 American Society for Testing and Material (1998). "Standard Practice For Dissolving Polymer Materials." Philadelphia (D 5226).
- 114 American Society for Testing and Material (2000). "Standard Practical For Determination of Structural Features in Polyolefin's and Polyolefin Copolymers By Infrared Spectrophotometers (FT-IR)." Philadelphia (D 5576).
- 115 American Society for Testing and Material (1998). "Standard Test Method For Vinyl and Trans Unsaturation in Polyethylene By Infrared Spectrophotometers." Philadelphia (D 6248).
- 116 Cambridge Polymer Group, Inc. (2000). "FTIR Quantification of Absorbed Radiation Dose In Polyethylene". United Kingdom: Technical Notes.
- 117 . J.V.Gulmine, P.R.Janissek, H.M.Heise and L.Akcelrud (2001). "Polyethylene Characterization By FTIR". Polymer Testing.
- 118 Silverslonein.R.M. *Spectrometric Identification of Organic compound*. 5th.ed. England.: John Wiley & Son. 1991
- 119 Gunther Kampf. *Characterization of Plastics By Physical Methods*. London.: Hanser Publishers. 1986
- 120 Yeong-Tarnq Shieh ,Jia-Sheng Lian and Tzung-Kai Chen. An Investigation of Water Crosslinking Reactions of Silane-Grafted LDPE. *Journal of Applied Polymer Science*. 2001. Vol (81): 186-196.

- 121 Yeong-Tarnng Shieh ,Jui-Shui Chen and Chung-Chin Lin. Thermal Fractionation and Crystallization Enhancement of an Investigation of Silane-Grafted Water-Crosslinked Low-Density Polyethylene. *Journal of Applied Polymer Science*. 2001. Vol(81): 591-599.
- 122 American Society for Testing and Material. *Standard Test Method For Enthalpies of Fusion and Crystallization of Polymers by Differential Scanning Calorimeter (DSC)*. Philadelphia, D 3417. 1999
- 123 American Society for Testing and Material. *Standard Test Method For melting and Crystallization Temperature By Thermal Analysis*. Philadelphia, E 794. 1998
- 124 American Society for Testing and Material. *Standard Test Method For Rapid Thermal Degradation of Solid Electrical Insulating Material By Thermogravimetric Method (TGA)*. Philadelphia, D 3850. 2000
- 125 American Society for Testing and Material. *Standard Test Method For Rubber-Compositional Analysis by Thermogravimetry (TGA)*. Philadelphia, D 6370. 1999
- 126 Deng. H and R.Hackam. Hydrophobic Property of XLPE Filled With Calcium Carbonate. *IEEE Transactions on Dielectrics and Electrical Insulation*. 1996. Vol (3): No.4. 577-586.
- 127 American Society for Testing and Material. *Standard Test Method For Density of Plastics by the Density -Gradient Technique*. Philadelphia, D 1505. 1998

- 128 Coleman M.M., C.J. Serman, D.E. Bhagwagar and P.C. Painter.
Fundamentals of Polymer Science. U.K.: Technomic Publishing Company,
Inc.1994.
- 129 Ho-Gab Jeong and Ki-Jun Lee. Effect of Discontinuous Phase size on
Physical properties of LLDPE/PP Blends obtained in the Presence of
Peroxide. *Advances in Polymer Technology*.1999.Vol(18): 43-51.
- 130 Xanthos M, Yu D. W, and G. Gogos. Peroxide modified polyolefin blends -
Part II: Effects on LDPE/PP blends with polymer components of dissimilar
initial viscosities. *Advances in Polymer Technology*.1992. Vol(11): 295-304.
- 131 Manas-Zloczower. I. and Z. Tadmor. *Mixing and compounding of polymers*.
Theory and practice. Munich.: Hanser. 1994
- 132 Antonovskii V.L. *Organic peroxide initiators*. Moscow.: Khimia. 1972
- 133 Felipe W. Fabris, Fernanda C. Stedile, Raquel S. Mauler and Sônia M. B. Free
Radical Modification of LDPE With Vinyltriethoxysilane. *European Polymer
Journal*. 2004. Vol(40): 1119-1126.
- 134 Hogt AH, Jelenic J, Meijer J. Polyolefins. *Polymer Processing European
Meeting*. September 26–28,1995. Stuttgart, SPE.1995. 32.
- 135 American Society for Testing and Material. *Standard Specification For Cross-
Linked Ethylene Plastics*. Philadelphia, D 2242. 1998
- 136 M.Dural,Y.Giguere,J.Liq.Chromomatogr.5(1982)1874
- 137 M.Dural,H.St-Onge IEEE Trans.Electr.Insul.14 (1979)264

- 138 L.Novakavic, O.Gal, A .Ccharlesby,Radiat.Phys.Chem.35(1990)181.
- 139 O.Gal,V.M.Markovic, L.R. Novakavic,V.T.Stannett,Radiat.Phys.Chem.26 (1985).325
- 140 G. Dörner and R. W. Lang. Influence Of Various Stabilizer Systems On The Ageing Behavior of PE-MD—II. Ageing of Pipe Specimens In Air And Water At Elevated Temperatures. *Polymer Degradation and Stability*. 1998. Vol(62) : 431-440.
- 141 Z.Fang,C.Xu,G.Shao,Q.Lu (1995).Polymer Eng Sci.57.271
- 142 T.Bremner ,A.Rudin, (1992). J.Appl.Polym. Sci.32 . 921.
- 143 Wolfgang Voigt and Roberto Todesco. New Approaches To The Melt Stabilization of Polyolefins. *Polymer Degradation and Stability*. 2002.Vol (77): 397-402.
- 144 Brandrup. J. and Immergut. E. H. *Polymer Handbook*. 3rd.ed. New York.: John Wiley & Sons. 1989
- 145 Bullen, D. J.; Capaccio, G.; Frye, C. J.; Brock, T. Br .(1989). Journal of Polymer ,21, 117–123.
- 146 Cartasegna. S. Silane-Grafted/Moisture-Curable Ethylene-Propylene Elastomers For The Cable Industry. *Rubber Chemistry and Technology*. 1986. Vol(59): Issue 5. 722-739.
- 147 Wong, W. K and Varrall, D. C. Role of Molecular Structure on The Silane Crosslinking of Polyethylene: The Importance of Resin Molecular Structure Change During Silane Grafting. *Polymer*. 1994. Vol(35): 5447–5452..

- 148 Chester S. Sheppard and Vasanth R. Kamath. The Selection and Use of Free Radical Initiators. *Polymer Engineering and Science*.1979. Vol(19) :597-606.
- 149 T. Hjertberg, M. Palmlöf, B.-Å. Sultan. Chemical Reactions In Crosslinking of Copolymers of Ethylene and Vinyltrimethoxy Silane. *Journal of Applied Polymer Science*. 1991. Vol (42): Issue 5. 1185-1192.
- 150 Johnston, R. T.; Morrison, E. J. Adv .(1996).Chem Ser , 249, 651–682.
- 151 Achintya Kumar Sen, Bibha Mukherjee, A. S. Bhattacharyya, P. P. De and Anil K. Bhowmick. Kinetics of Silane Grafting and Moisture Crosslinking of Polyethylene and Ethylene Propylene Rubber. *Journal of Applied Polymer Science*. 1992. Vol (44): 1153-1164.
- 152 Palmlöf. M, T. Hjertberg, B.-Å. Sultan. Crosslinking Reactions of Ethylene Vinyl Silane Copolymers at Processing Temperatures. *Journal of Applied Polymer Science*. 1991. Vol(42): 1193-1203.
- 153 Forsyth, J. C.; Baker, W. E.; Russell, K. E.; Whitney,R. A. Peroxide-initiated vinylsilane grafting: structural studies on a hydrocarbon substrate. *Journal of Polymer Science, Part A: Polymer Chemistry*. Vol(35): 3517–3525.
- 154 Anderson, R.; Arkles, B.; Larson, G. L. In. SiliconCompounds; Petrarch Systems, Silanes and Silicones Group: Bristol, PA, 1987.
- 155 Stoyanov, O.V., Deberdeyer, R.Ya. Shmakova and O.P.&Svetlakov,N.V. *Polymer Sciences USSR*.1986. Vol (28): 2416-2423.
- 156 Bongardt,J, G. H. Michler, I. Naumann and G. Schulze. Zur morphologie von peroxidisch vernetztem polyethylene. *Angewandte Makromolekulare Chemie*. 1987. Vol(153): 55-70

- 157 M. Lazar, R. Rado and J. Rychly. The decomposition of benzoyl peroxide in polyethylene. *Advance Polymer Science*. 1990. Vol (95): 149-156.
- 158 Zoepfl. F. J, V. Markovi, Joseph Silverman. Differential Scanning Calorimeter Studies of Irradiated Polyethylene: I. Melting Temperatures and Fusion Endotherms. *Journal of Polymer Science: Polymer Chemistry* . 1984. Vol(22): 2017-2032.
- 159 Narkis, M.; Raiter, I.; Shkolnik, S.; Eyerer, P.; Siegmann, A. Structure And Tensile Behavior of Irradiation- and Peroxide-Crosslinked Polyethylene's. *Journal Macromolecule Science*. 1987. Vol (26): 37-58.
- 160 Amparo Ribes-Greus and Ricardo Diaz-Calleja. Relationship between the mechanical relaxations in the α zone and the calorimetric transitions in low density polyethylene. *Journal of Applied Polymer Science*. Vol (34): 2819-2828.
- 161 B.A. Brikman. Reactivity of addends in the reaction of its dien synthesis. *Uspekhi Khimi*. 1983. Vol (52): 852-1878 .
- 162 T. M. Liu and W. E. Baker. The Effect of The Length of The Short Chain Branch on The Impact Properties of Linear Low Density Polyethylene. *Polymer Engineering & Science*. 1992. Vol (32): 944-955.
- 163 S. W. Tsui, R. A. Duckett, and I. M. Ward. Structure-Property-Processing Relationships In Chemically Modified Polyethylene. *Journal of Material Sciences*. 1992. Vol (27): 2799-2806.
- 164 Zhou, Xiao-Qi and Hay, J. N. Fractionation and Structural Properties of Linear Low Density Polyethylene. *European polymer journal*. 1993. Vol (29): 291-230.

- 165 Schultz. J. M. *Polymer Materials Science*. Englewood Cliffs, N. J.: Prentice Hall .1974
- 166 DeCandia. F, R. Russo, V. Vittoria, A. Peterlin. Mechanical And Transport Properties of Drawn Crosslinked Low Density Polyethylene. *Journal of Polymer Science: Polymer Physics Edition*. 1982. Vol(20): 269-277.
- 167 American Society for Testing and Material. *Specification for Oxidative Induction Time (OIT)*.. Philadelphia, D3895. 1995
- 168 Addersion L.H.U, B.Gustafsson ,T. Hjertberg. Crosslinking of Bimodal Polyethylene. *Journal of Polymer*. 2004. Vol(45): 2577-2585.
- 169 Kalyanee Sirisinha, Darinya Meksawat. Changes in Properties of Silane - Water Crosslinked Metallocene Ethylene-Octane Copolymer After Prolonged Crosslinking Time. *Journal of Applied Polymer Science*. 2004. Vol(93): 901-906.
- 170 Ramasatamy Anbarasan, Olide Babot, Bernad Maillard. Crosslinking of High Density Polyethylene in the Presence of Organic Peroxide. *Journal of Applied Polymer Science*. 2004. Vol(93) : 75-81.
- 171 Gul Bali Shah, Mohammad Fuzail, Jamil Anwar. Aspect of the Crosslinking of Polyethylene with Vinyl Silane. *Journal of Applied Polymer Science*. 2004. Vol(92): 3796-3803.

DESIGN AND FORMULATING SILANE CROSSLINKABLE EXTRUSION
BLOW MOLDED HIGH DENSITY POLYETHYLENE COMPOUND

TOH SHOW CHONG

A thesis submitted in fulfilment of the
requirements for the award of the degree of
Master of Engineering (Polymer)

Faculty of Chemical and Natural Resource Engineering
Universiti Teknologi Malaysia

JANUARY 2005

I declare that this thesis entitle “*Design and Formulating Silane Crosslinkable Extrusion Blow Molded High Density Polyethylene Compound*” is the result of my own research except as cited in the references. The thesis has not been accepted for any degree and is not concurrently submitted in candidature of any degree.

Signature : _____

Name : **TOH SHOW CHONG**

Date : **12/01/2005**

‘Specially for My Parents’.

ACKNOWLEDGEMENTS

First and foremost, I would like to express my heartfelt gratitude to my supervisor, Associate Professor Dr. Wan Aizan Bt Wan Abdul Rahman; I greatly appreciate the importance and positive contribution that she has made to the career that I enjoy so much. She has been an excellent example to me.

I wish to express my deep appreciation and sincere thanks to Associate Professor Dr. Shahrir Haji.Hashim and Associate Professor Hanizam Sulaiman. This project would not have been possible without their necessary resources provided me.

I also wish to thank all the technicians of Laboratory of Polymer Engineering at University Teknologi Malaysia for providing the technical support.

I am gratefully acknowledged to UTM-RMC Vote 71815 and School of Graduate Studies UTM for the generous financial and providing me scholarship, UTM-PTP to carry out the study.

Finally, I would like to express my gratitude to my parents and S.Y. Leong, the entire lecturers from polymer engineering department and those who have directly or indirectly assisted me in the preparation of this thesis. Thank You.

ABSTRACT

A formulation was designed to produce silane crosslinkable HDPE compound suitable for extrusion blow molding by melt blending technique on Magic[®] extrusion blow molding machine. The formulations consist of HDPE as the base polymer, a carrier chemical pack containing an organic unsaturated silane and a free radical generating agent and condensation catalyst. In designing and formulating silane crosslinkable blow molded HDPE compounds with satisfactory properties, ASTM D 2647 was used as the reference. Grafting and crosslinking reaction was proposed for the formulated system. The product was characterized for the chemical, thermal, physical and mechanical properties. The chemical reactions during grafting and crosslinking involved a three step mechanisms. Extrusion blow molded bottle were stored in water for curing at various temperature and time. DSC, FTIR and TGA were used to determine the chemical groups involved in the reactions and gel contents were determined in parallel. The results from curing showed that a further formation of Si-O-Si crosslink's took place after the point at which maximum gel contents has been reached. Mechanical measurements indicated that further crosslink's were formed within the existing gel. Suitable range concentration relating to 100 parts of base polymer was found for vinyltrimethoxysilane (VTMO) to be between 1.6 to 2.0 phr. The concentration of dicumyl peroxide (DCP) initiator was between 0.1 to 0.5 phr. The concentration of dibutyltin dilaurate (DBTL condensation catalyst) was being 0.005 to 0.02. When the DBTL amount was less than 0.005 phr, the crosslinking reaction did not proceed sufficiently. When the DBTL amount was larger than 0.02 phr, local crosslinking proceeds in the extruder at the time of extrusion, resulting in a greatly deteriorated appearance of the product. The selected components used in the formulation are HDPE grade HB6200, vinyltrimethoxysilane (VTMO) as the crosslinking agent, dicumyl peroxide (DCP) as the initiator, dibutyltin dilaurate (DBTL) as the condensation catalyst and Irganox 1010 as the antioxidant. The blow molded bottle properties and processability of the compound depends on the formulation and process parameter.

ABSTRAK

Formulasi telah direkabentuk untuk menghasilkan sebatian HDPE berangkai silang yang sesuai untuk penyemperitan tiupan dengan teknik penyemperitan reaktif pada mesin Magic[®]. Formulasi ini mengandungi HDPE sebagai polimer asas, pembawa kimia yang mengandungi silane tidak tepu, agen penjanaan radikal bebas dan pemangkin kondensasi. Dalam rekaan formulasi sebatian HDPE berangkai silang, ASTM D2647 dirujuk. Tindak balas pencantuman dan perangkaian silang digunakan dalam sistem formulasi. Produk diciri berdasarkan sifat kimia, terma, fizik dan mekanik. Tindak balas kimia semasa pencantuman dan perangkaian silang melibatkan tiga langkah mekanisma. Botol penyemperitan adunan disimpan dalam air untuk pengawetan pada pelbagai suhu dan masa. DSC, FTIR, TGA digunakan untuk penentuan kumpulan kimia yang terlibat dalam tindak balas kimia dan kandungan gel. Keputusan daripada pengawetan menunjukkan bahawa formulasi ikatan Si-O-Si berlaku selepas takat kandungan maksima gel tercapai. Ukuran mekanik menunjukkan bahawa perangkaian silang seterusnya terbentuk dalam keadaan gel yang tersedia ada. Julat kepekatan yang bersesuaian berdasarkan 100 bahagian polimer asas untuk vinyltrimethoxysilane (VTMO) ialah 1.6 hingga 2.0 phr. Kepekatan pemula dicumyl peroxide (DCP) ialah 0.1 hingga 0.5phr. Kepekatan pemangkin kondensasi dibutyltin dilaurate (DBTL) ialah 0.005 hingga 0.02. Apabila kepekatan DBTL kurang daripada 0.005 phr, tindak balas berangkai silang tidak berlaku dengan berkesan. Apabila kepekatan DBTL lebih daripada 0.002 phr, perangkaian silang setempat berlaku dalam penyemperit pada masa penyemperitan, menyebabkan kemerosotan permukaan produk. Komponen terpilih dalam formulasi ini ialah HDPE gred HB6200, vinyltrimethoxysilane (VTMO) sebagai agen perangkaian silang, dicumyl peroxide (DCP) sebagai pemula, dibutyltin dilaurate (DBTL) sebagai pemangkin kondensasi dan Irganox 1010 sebagai anti bahan pengoksidaan. Sifat dan kebolehprosesan botol penyemperitan adalah bergantung pada formulasi dan parameter proses.