

Numerical Simulation of a Flexible Plate System for Vibration Control

A.R. TAVAKOLPOUR, I.Z. MAT DARUS, M. MAILAH
Department of Applied Mechanics, Faculty of Mechanical Engineering
Universiti Teknologi Malaysia
81310 Skudai, Johor Bahru
MALAYSIA
alitavakolpur@yahoo.com; intan@fkm.utm.my; musa@fkm.utm.my.

Abstract: - This research presents an investigation into the numerical simulation of a flexible thin plate using Finite Difference (FD) and Finite Element (FE). Based on the FD method, an appropriate model of a thin plate was derived and its corresponding natural frequencies were estimated. Then, FE modeling of the plate system was implemented using the ANSYS software and the corresponding modes of vibration were computed by modal analysis. The obtained vibration modes for both models were then evaluated and compared. A number of attempts have been carried out to determine the nodal lines on the plate in order to identify the critical observation points for appropriate locations of the sensors using the FE simulation. Finally, the effectiveness of FD method for real time application was verified by comparative assessment of the obtained natural frequencies with the exact value reported by other researchers. The FD method was found to be the better choice than FE method to model a plate structure for real-time active vibration control.

Key-Words: - Finite Difference, Finite Element, Flexible Plate, Active Vibration Control, Dynamic Modeling.

1 Introduction

Plates are the most commonly used element in mechanical structures and machines such as aircrafts, ships and submarines. In designing a structure, plates are usually specified only to withstand applied static loads. However, this is inadequate for more accurate applications. Dynamic forces and random cyclic loads also threaten the stability of a system. There exist a large number of discrete frequencies at which a rectangular plate will undergo large amplitude vibration by sustained time varying forces of matching frequencies. Thus, the possibility of large displacement and stresses due to this recent type of excitation must be taken into account.

The usual method to avoid the failure of flexible thin plates due to vibratory disturbances is to alter the geometry or boundary conditions of the plate according to the frequency value of the vibration sources. Sometimes, it would be impossible to anticipate the frequency of disturbances owing to time dependent characteristics of the destructive vibrations. Because of this drawback, the idea of controlling the unwanted vibrations came into being. To reduce the amplitude of the destructive vibration in a structure, two control strategies, namely the passive and active methods can be employed. The

passive method consists of mounting passive material on the structure. This method is relatively efficient at high frequencies but expensive and bulky at low frequencies. The active method in controlling vibration uses the superposition of waves by generating secondary source(s) to destructively interfere with the unwanted source and thus result in a reduction in the level of vibration. This is found to be more efficient and economical than the passive method at low frequency vibration suppression [1]. To design a suitable controller for active vibration control of a flexible thin plate, it is vital to have a good understanding about the dynamics of a system. The dynamic behavior of thin isotropic rectangular plates is a subject that has received considerable attention in recent years because of its technical importance.

Leissa [2] carried out intensive studies on the dynamics of thin plates and shells. He investigated the natural frequencies of rectangular thin plate theoretically and experimentally. He obtained the dimensionless frequency parameters corresponding to the modes of vibrations of a fourfold symmetry square plate. Maruyama and Ichinomiya [3] surveyed the free vibration of clamped rectangular plates with straight narrow silts experimentally. They applied the real-time technique of time-averaged holographic interferometry to determine

the natural frequencies and the corresponding mode shapes of a clamped rectangular plate. Furthermore, the effect of lengths, positions and the inclination angles of silts on the natural frequencies and the corresponding mode shapes were presented.

Gorman [4], Used the method of superposition to analyze the free in-plane vibration of a rectangular plate. He expressed that the convergence was very rapid and excellent between computed results and those obtained by previous authors utilizing the Rayleigh–Ritz energy method. Saha *et al.* [5] proposed a new methodology that could be employed for plate structure problems having any combination of boundary conditions to determine the non-linear frequencies and mode shape. Their proposed solution methodology could be applied to any kind of boundary conditions.

Yaman, Caliskan, Nalbantoglu, Prasad and Waechter [6] employed ANSYS® (V. 5.6) software to derive the FE model of a smart flexible plate. The solid type element SOLID5 with three degrees of freedom per node was used. They applied the theoretical results of the model for active vibration control of an aluminum thin plate. Tawfik [7] proposed the spectral FE model for plate vibrations. He compared the models of a classical 3rd order/4-node element, a seventh order/16 node element, and the proposed spectral FE model.

Mat Darus and Tokhi [8] implemented an investigation into the dynamic characterization of a two dimensional (2D) flexible structure for the purpose of active vibration control. A simulation algorithm characterizing the dynamic behavior of the plate was developed through a discretisation of the governing partial differential equation formulation using FD method. Numayr and Haddad [9] employed the FD method to solve the differential equations of free vibration of composite plates. Also the effects of shear deformation and rotary inertia on the natural frequencies of the laminated composite plates were investigated.

Based on the previously outlined literature, there seems to be inadequate report on the comparative performance between the FD and FE methods for modeling and simulation of rectangular thin plates. Thus, this paper attempts to carry out a direct comparative study on the performance of the two methods applied to thin plate for the purpose of active vibration control. The first step would be to evaluate the FD method to simulate a flexible thin plate. Then, the FE modeling of the system is implemented using the ANSYS® (V. 5.4) software and the modal analysis would be carried out to investigate the vibration characteristic of the plate. The acquired results are compared to the

experimental and analytical data presented by other researchers to validate the proposed algorithm used in the study. Finally, the most suitable model for real-time design and implementation of an active vibration controller for a rectangular thin plate is defined.

2 Dynamic of thin plates

In this study a flexible thin plate was considered to be in the x-y plane and the direction of transverse displacement was assumed to be parallel to the z-axis. Furthermore, the plate is assumed to undergo a small lateral deflection. The free-body diagram of a plate element has been depicted in Fig. 1.

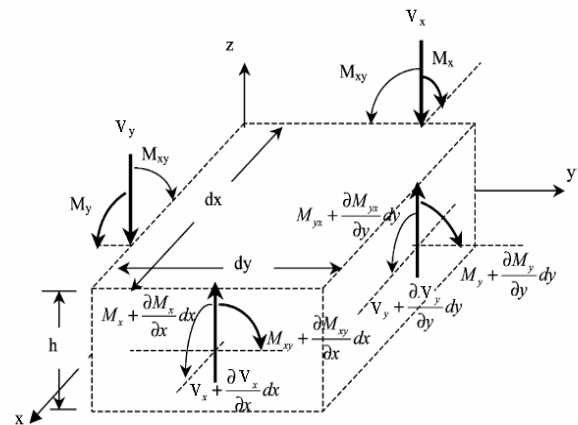

Fig. 1. Free-body diagram of an element located on the plate

In Fig. 1, dx , dy and h are the width, length and thickness of the plate element respectively. V_x and V_y are shear force acting on the element's face perpendicular to y -axis and x -axis. M_x and M_y are bending moments on the element faces and M_{xy} and M_{yx} are twisting moment acting on the element.

From Newton's second law, the corresponding equation of motion of the plate element can be expressed as follows:

$$\begin{aligned} & (V_x + \frac{\partial V_x}{\partial x} dx) - V_x + (V_y + \frac{\partial V_y}{\partial y} dy) - V_y = \\ & = -\rho(dx dy)h \frac{\partial^2 w}{\partial t^2} \end{aligned} \tag{1}$$

Where w is the lateral deflection of the plate and ρ is the density of plate with dimension mass per unit volume. Dividing Eq. (1) by $(dx dy)$:

$$\frac{\partial Q_x}{\partial x} + \frac{\partial Q_y}{\partial y} + \rho h \frac{\partial^2 w}{\partial t^2} = 0 \quad (2)$$

Where $Q_x = V_x/dy$ and $Q_y = V_y/dx$. From equilibrium laws $\Sigma M_y = 0$ and $\Sigma M_x = 0$, it can be proved that:

$$\frac{\partial Q_x}{\partial x} = \frac{\partial^2 M_{yx}}{\partial x \partial y} + \frac{\partial^2 M_x}{\partial x^2} \quad (3)$$

$$\frac{\partial Q_y}{\partial y} = -\frac{\partial^2 M_{xy}}{\partial x \partial y} + \frac{\partial^2 M_y}{\partial y^2} \quad (4)$$

Using Eqs. (2), (3) and (4) and the assumption of $M_{xy} = -M_{yx}$:

$$\frac{\partial^2 M_x}{\partial x^2} + \frac{\partial^2 M_y}{\partial y^2} - 2 \frac{\partial^2 M_{xy}}{\partial x \partial y} = -\rho h \frac{\partial^2 w}{\partial t^2} \quad (5)$$

By referring to the theory of rectangular thin plate, the moments are obtained by multiplying the stress σ by the corresponding moments arm and integrating over the plate thickness:

$$M_x = -D \left(\frac{\partial^2 w}{\partial x^2} + \nu \frac{\partial^2 w}{\partial y^2} \right) \quad (6)$$

$$M_y = -D \left(\frac{\partial^2 w}{\partial y^2} + \nu \frac{\partial^2 w}{\partial x^2} \right) \quad (7)$$

Where $D = (Eh^3)/(12(1-\nu^2))$ is flexural rigidity, E is the modulus of elasticity and ν is Poisson ratio.

However, the two bending moments M_x and M_y are not the only moments that act a plate element. The torsional moments M_{xy} and M_{yx} also affect the plate element and can be calculated as follows [10]:

$$M_{xy} = D(1-\nu) \frac{\partial^2 w}{\partial x \partial y} \quad (8)$$

By substituting the expression given by Eqs. (6), (7) and (8) into Eq. (5) and carrying out the required mathematical manipulations, the following Equation of motion for the free vibration of thin rectangular plates may be obtained:

$$\frac{\partial^4 w}{\partial x^4} + 2 \frac{\partial^4 w}{\partial x^2 \partial y^2} + \frac{\partial^4 w}{\partial y^4} + \frac{\rho h}{D} \frac{\partial^2 w}{\partial t^2} = 0 \quad (9)$$

For a plates subjected to dynamic force excitation q which applied as normal to the surface of the plate, the differential equation of motion is obtained as:

$$\frac{\partial^4 w}{\partial x^4} + 2 \frac{\partial^4 w}{\partial x^2 \partial y^2} + \frac{\partial^4 w}{\partial y^4} + \frac{\rho h}{D} \frac{\partial^2 w}{\partial t^2} = \frac{q}{D} \quad (10)$$

Thus, the vibration problem of a flexible thin plate can be formulated as what was computed in Eq. (10) together with corresponding boundary conditions.

For a clamped edge (at $x=a$), the boundary condition is as follows:

$$w \Big|_{x=a} = \frac{\partial w}{\partial x} = 0 \quad (11)$$

For simulation purpose, it is natural to assume that initially the plate has no deflection. In other words, the forces and moments of the plate due to its weight are neglected. Thus, for every points located on the plate:

$$w \Big|_{t=0} = 0 \quad (12)$$

3 Analysis

A number of analytical approaches were proposed by different researchers to solve the plate differential equation of motion. FE and FD methods are known to be the most widely used numerical procedures to solve the mentioned differential equation. An advantageous of FE method is that it is very suitable for practical engineering problems of complex geometries. However, the computational complexity involved in this method constitutes the main disadvantage of this technique, especially in real-time application [12]. On the other hand, the FD method is relatively easy to program, fast enough to analyze and also seems to be more convenient for uniform structures such as plate system. The main serious drawback of FD method is that it is not suitable for problems with awkward and irregular geometries. Furthermore, since it is difficult to vary the size of the difference cell in particular regions, it is not suitable for problems with rapidly changing variables such as stress concentration problems. In any case, because of the geometry uniformity of the thin plates, FD method seems to be more applicable and faster to calculate especially for the case of real-time design of an active vibration controller.

In FD method, the entire solution domain is divided into a grid of cells. Then, the derivatives in

the governing partial differential equations are written in terms of difference equations. Therefore, the FD is applied to each interior point so that the displacement of each node is related to the values at the other nodes in the grid connected to it. Considering the boundary conditions of the problem, a unique solution can be obtained for the overall system. In the case of a flexible plate, a three dimensional coordinate system is considered. The x -axis is represented with the reference index i , the y -axis with reference index j and the time axis with index k , where $x=i\Delta x$, $y=j\Delta y$ and $t=k\Delta t$. For each nodal point in the interior of the grid (x_i, y_j, t_k) where $i = 0, 1, \dots, n; j = 0, \dots, m$ and $k = 0, 1, \dots, p$, a Taylor series expansion is used to generate the central FD formulae for the partial derivative terms of the deflection, $w(x, y, t) = w_{i,j,k}$ of the plate at point $x = i \Delta x$, $y = j \Delta y$ and $t = k \Delta t$. Thus, using the central difference approximations, each partial derivatives of Eq. (10) can be substituted by a suitable difference equation as follows [11]:

$$\left(\frac{\partial^4 w}{\partial x^4}\right)_{i,j,k} = \frac{1}{\Delta x^4} (w_{i+2,j,k} - 4w_{i+1,j,k} + 6w_{i,j,k} - 4w_{i-1,j,k} + w_{i-2,j,k}) \quad (13)$$

$$\left(\frac{\partial^4 w}{\partial x^2 \partial y^2}\right)_{i,j,k} = \frac{1}{\Delta x^2 \Delta y^2} (4w_{i,j,k} - 2(w_{i+1,j,k} + w_{i,j+1,k} + w_{i-1,j,k} + w_{i,j-1,k}) + w_{i+1,j+1,k} + w_{i-1,j+1,k} + w_{i-1,j-1,k} + w_{i+1,j-1,k}) \quad (14)$$

$$\left(\frac{\partial^4 w}{\partial y^4}\right)_{i,j,k} = \frac{1}{\Delta y^4} (w_{i,j+2,k} - 4w_{i,j+1,k} + 6w_{i,j,k} - 4w_{i,j-1,k} + w_{i,j-2,k}) \quad (15)$$

$$\left(\frac{\partial^2 w}{\partial t^2}\right)_{i,j,k} = \frac{w_{i,j,k+l} - 2w_{i,j,k} + w_{i,j,k-l}}{\Delta t^2} \quad (16)$$

Substituting Eqs. (13), (14), (15) and (16) into Eq. (10) yields:

$$\begin{aligned} w_{i,j,k+l} = & -\frac{D\Delta t^2}{\rho h} (Pw_{i,j,k} + Q(w_{i+1,j,k} + w_{i-1,j,k}) + \\ & + (w_{i,j+1,k} + w_{i,j-1,k}) + S(w_{i+1,j+1,k} + w_{i-1,j+1,k} + \\ & + w_{i-1,j-1,k} + w_{i+1,j-1,k}) + T(w_{i+2,j,k} + w_{i-2,j,k}) + \\ & + U(w_{i,j+2,k} + w_{i,j-2,k})) + 2w_{i,j,k} - w_{i,j,k-l} + \frac{\Delta t^2 q_{i,j}}{\rho h} \end{aligned} \quad (17)$$

Where

$$\begin{aligned} P &= \frac{6}{\Delta x^4} + \frac{8}{\Delta x^2 \Delta y^2} + \frac{6}{\Delta y^4}, \quad Q = -\frac{4}{\Delta x^4} - \frac{4}{\Delta x^2 \Delta y^2}, \\ R &= -\frac{4}{\Delta y^4} - \frac{4}{\Delta x^2 \Delta y^2}, \quad S = \frac{2}{\Delta x^2 \Delta y^2}, \quad T = \frac{1}{\Delta x^4}, \\ U &= \frac{1}{\Delta y^4}. \end{aligned}$$

The central difference equation for boundary and initial conditions defined by Eqs. (11) and (12) for a clamped edge (at $x=a$) can be written as:

$$w|_{x=a} = \frac{\partial w}{\partial x}|_{x=a} = \frac{1}{2\Delta x} (w_{i+1,j,k} - w_{i-1,j,k}) = 0 \quad (18)$$

According to Eq. (12) the displacement of entire nodes on the plate at $t=0$ is assumed to be zero. Therefore,

$$w_{i,j,k}|_{t=0} = 0 \quad (19)$$

The stability of the algorithm can be examined by ensuring that the iterative scheme described in Eq. (17) converges to a solution. According to the stability rules for convergence of a finite difference equation, Eq. (20) can be derived to satisfy the necessary condition for convergence of Eq. (17) as follows [13]:

$$0 \leq c \leq \frac{1}{4} \quad (20)$$

Where

$$c = \left(\frac{D\Delta t^2}{\rho \Delta x^2 \Delta y^2}\right) \left(2 + \frac{\Delta y^2}{\Delta x^2} + \frac{\Delta x^2}{\Delta y^2}\right)$$

To have an appropriate platform for comparing the performance of the mentioned FD model with FE method, an attempt was made to model and simulate the plate system using the FE method within ANSYS® (V. 5.4) software. One of the most familiar element types for structural vibration analysis is the solid type elements comprising three displacement degrees of freedoms per node [6].

The solid model of the plate system was produced within the ANSYS environment considering the solid type brick element with 8 nodes to mesh the model. Then, the modal analysis was carried out to investigate the first five natural frequencies of the plate.

3 Results and Discussion

To study the dynamic behavior of the thin plate, an aluminum plate with thickness of 3.2mm and 1.5m (length) \times 1m (width) with clamped edges was considered as shown in Fig. 2.

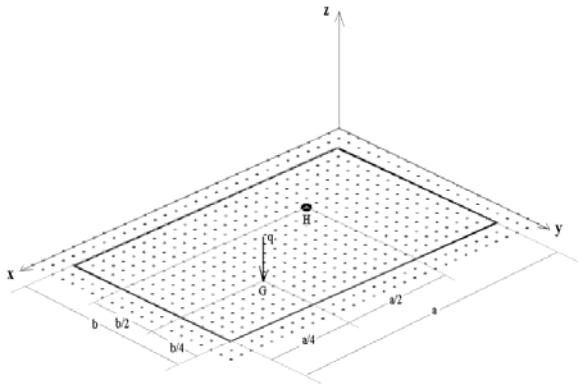

Fig. 2. Schematic diagram of the rectangular thin plate

An excitation force input, $q=160\text{Nm}^{-2}$ at $t=0.01\text{s}$ to $t=0.03\text{s}$ was exerted on the plate at point G (Fig. 3) and the dynamic response of the plate at point H during one second was investigated. It is expected that a vibratory signal is transmitted at point H.

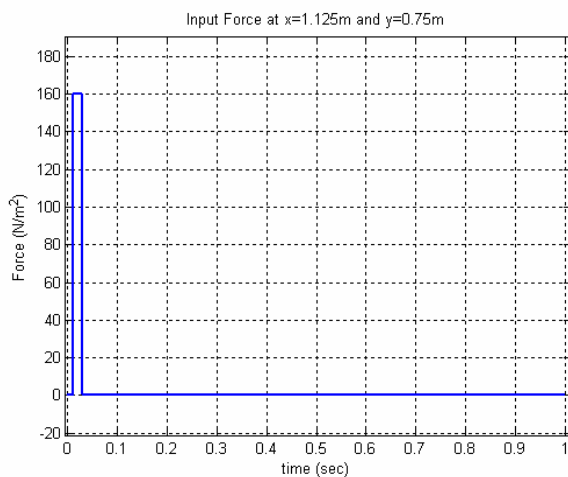

Fig. 3. Input force applied to point G

To simulate the behavior of the plate system, a computer program was written to analyze the dynamics based on Eq. (17) using MATLAB (V.

7.3). Fig. 4 shows the simulated response of the plate in time domain at $x=a/3$ and $y=b/3$ (where $a=1.5\text{ m}$ and $b=1\text{ m}$) from the origin during one second. For the simulation process, the length and width of the plate were divided into 30 and 20 segments respectively to produce square difference elements. The value of c is assumed to be 0.1 to satisfy the stability condition as specified by Eq. (20). As can be observed in Fig. 4, the plate shows a highly non-linear characteristic at point H when subjected to an excitation force.

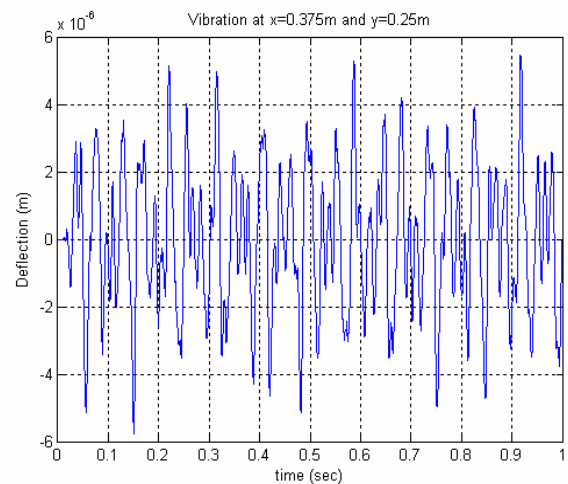

Fig. 4. Dynamic response of the plate at point H

To investigate the validity of the proposed FD simulation shown in Fig. 4, the spectral density of the deflection of the plate (based on system eigenvalues) at point H was calculated by Fast Fourier Transform (FFT) analysis using MATLAB. The first five resonance modes of the plate system were studied. Then, the estimated resonance modes will be compared to those obtained through the FE simulation or other analytical data reported by other researchers. Fig. 5 shows the corresponding frequency-domain characteristic of the plate's vibration subjected to a finite duration step input using FD model.

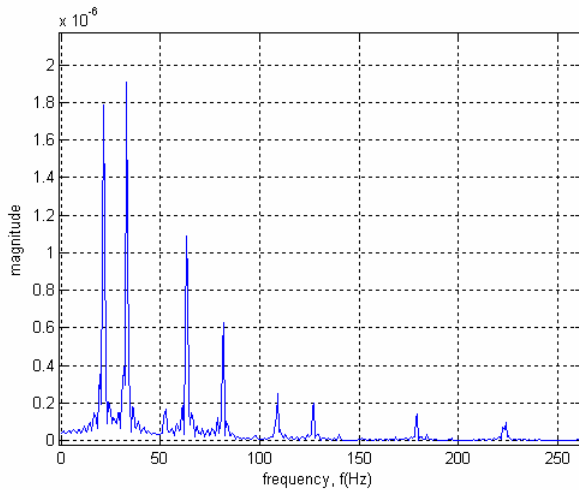

Fig. 5. Frequency-domain response of the plate at point H

As can be observed, the first five resonance modes of vibration have occurred at 21.25 Hz, 32.925 Hz, 52.68 Hz, 62.93 Hz and 81.94 Hz respectively.

Using ANSYS® (5.4) Software, the FE model of the plate system was derived. The element SOLID45 with 8 nodes was employed to mesh the model and the length and width of the plate were divided to 30 and 20 elements respectively in order to have a better comparison with the FD model with 30×20 segments. The FE model of the plate with clamped edges utilized in this study is shown in Figure 6.

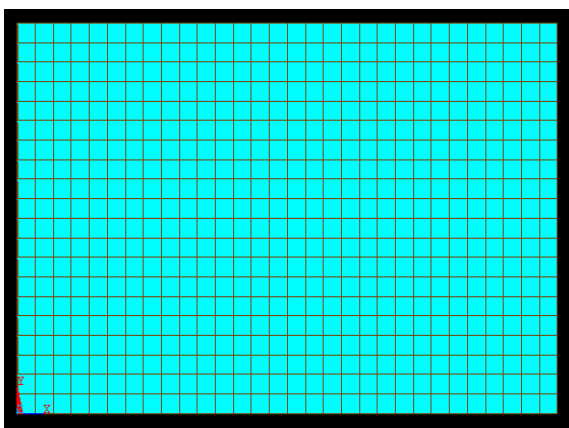

Fig. 6. FE model of the plate.

The first dominant five modes of vibration of the plate and its corresponding mode shapes were

investigated using modal analysis in ANSYS. Fig. 7 represents the results of FE simulation. As can be seen, the first five mode shapes of the plate system under free vibrations have been demonstrated.

The appropriate Locations of sensors on the plate are an important question arisen for designing the active vibration control system. The FE simulation revealed that the plate deflections at special locations known as nodal lines (Fig. 7.f) are zero. Then, for instance, if one just wants to control the second mode of vibration shown in Fig. 7.b it should be avoided to locate the sensor on the vertical line at the middle of the plate. Thus, to observe the first five resonance modes of vibration, the sensors should not be placed on the vicinity of the nodal lines shown in Fig 7.f.

The exact natural frequencies of a rectangular thin plate can be calculated as [14]:

$$f = \frac{\lambda^2}{2\pi a^2} \left[\frac{Eh^3}{12\rho h(1-\nu^2)} \right] \tag{21}$$

Where λ^2 is a dimensionless frequency parameter and f is the natural frequency of the plate. Many researchers have reported the appropriate value for λ^2 through which the exact natural frequencies of a thin plate can be computed according to the boundary conditions and the ratio of length to width of the plate (a/b) [2, 14, 15, 16]. For a rectangular thin plate with four clamped edges, the suitable values of the dimensionless frequency parameters can be found as shown in Table I as [15]:

TABLE I
The dimensionless frequency parameters (λ^2) for thin plates with four clamped edges

| $\frac{a}{b}$ | λ^2 | | | | | |
|---------------|-------------|-------|-------|--------|-------|-------|
| | Mode | | | | | |
| | 1 | 2 | 3 | 4 | 5 | 6 |
| 0.4 | 23.65 | 27.82 | 35.45 | 46.70 | 61.55 | 63.10 |
| 2/3 | 27.01 | 41.72 | 66.14 | 66.55 | 79.85 | 100.9 |
| 1.0 | 35.99 | 73.41 | 73.41 | 108.3 | 131.6 | 132.2 |
| 1.5 | 60.77 | 93.86 | 148.8 | 149.74 | 179.7 | 226.9 |
| 2.5 | 147.80 | 173.9 | 221.5 | 291.9 | 384.7 | 394.4 |

Using Table I, the exact natural frequencies of the mentioned thin plate with a dimension of 1.5m×1m were computed.

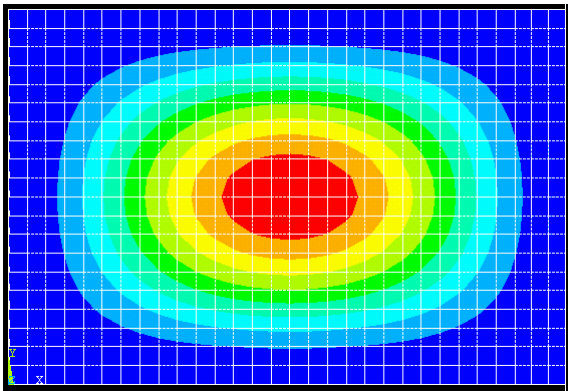

(a) Mode shape 1

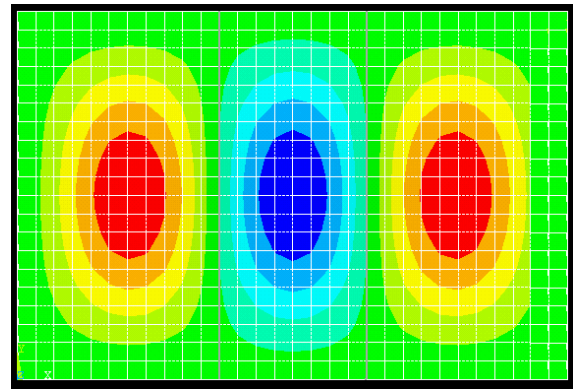

(d) Mode shape 4

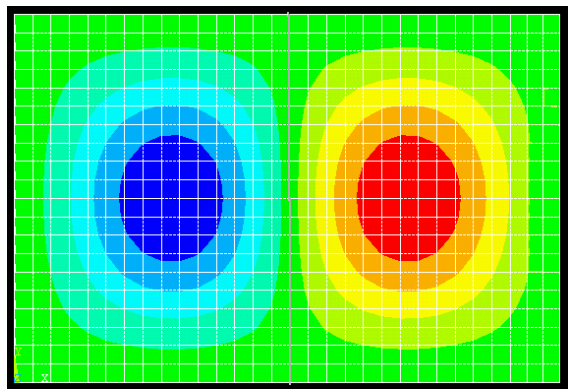

(b) Mode shape 2

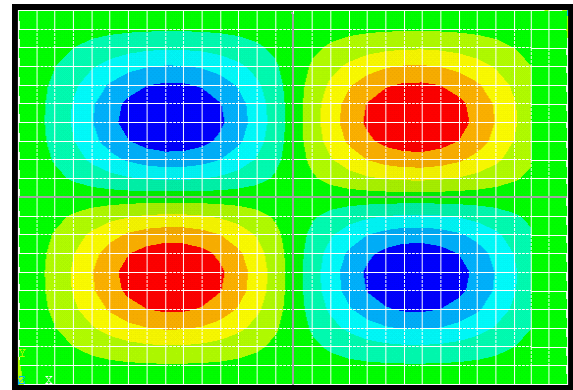

(e) Mode shape 5

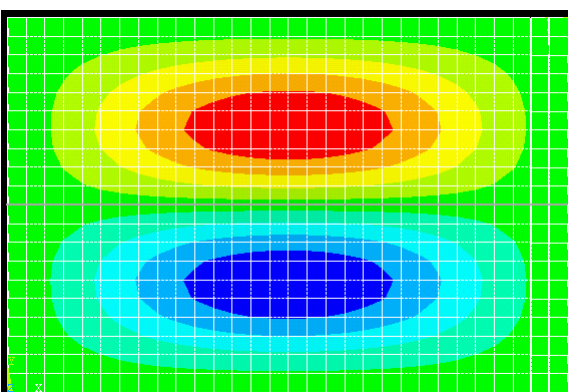

(c) Mode shape 3

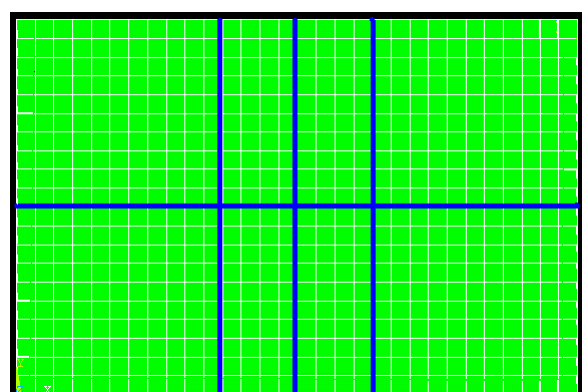

(f) Nodal lines

Fig. 7. FE simulation of the rectangular flexible thin plate

Table II shows the comparative results of FE and FD simulation for the first five natural frequencies of the plate system. It reveals that for equal numbers of segments (elements), the FD model estimates more accurate natural frequencies compared to the FE model. It should be noted that in order to obtain a good one-to-one comparative platform, the number of portions along the edges should be assumed to be equal in both models. By increasing the number of elements or using another types of solid elements such as SOLID92 (10 nodes per element) and SOLID95 (20 nodes per element), the FE model can estimate very accurate natural frequencies. However, it is done at the expense of very slow computation of the simulation program and thus not appropriate for real-time applications.

TABLE II
Comparative modes of vibrations among FD and FE models and experimental data

| $\frac{a}{b} = 1.5$ (Aluminum plate specifications: $a=1.5m, b=1m, \rho=2700Kg\,m^{-3}, h=3.2mm$) | | | | | |
|---|-------------------------------------|--------------------------|-------------------------------------|--------------------------|----------------------------|
| Mode | Natural Frequency for FD model (Hz) | Error (%) (For FD model) | Natural Frequency for FE model (Hz) | Error (%) (For FE model) | Reported data in [13] (Hz) |
| 1 | 21.22 | 0.70 | 22.66 | 5.00 | 21.39 |
| 2 | 32.92 | 0.03 | 36.58 | 11.08 | 32.93 |
| 3 | 52.68 | 0.04 | 56.35 | 6.90 | 52.70 |
| 4 | 62.92 | 0.50 | 73.86 | 16.77 | 63.25 |
| 5 | 81.94 | 2.60 | 91.19 | 14.27 | 79.80 |

To investigate how fast the proposed FD algorithm is, the processing time of the FD simulation algorithm for a different number of segments was studied. A new computer algorithm with three nest-loops was developed to speed up the execution time of the program for real-time application. The flowchart of the mentioned program has been depicted in Fig. 8. In this figure $w1(i,j)$, $w2(i,j)$ and $w3(i,j)$ are the deflection of plate at times $t-1$, t and $t+1$ respectively.

Table III shows the processing time for different number of segments along the edges of the plate using Intel Core™ Duo Processor. It can be noted that by increasing the number of segments along the edges of the plate, the corresponding processing time is increased which implies that the computation is slowed down.

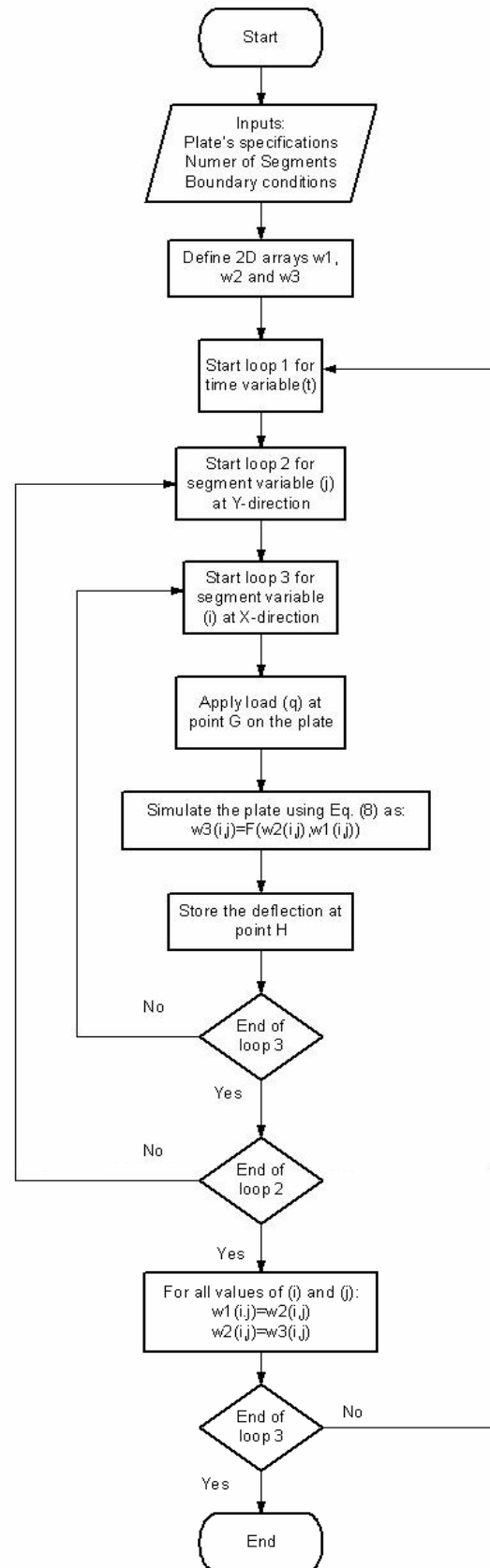

Fig. 8. Schematic flowchart of the program

TABLE III
Processing time with different number of
segments using Intel Core™ Duo Processor

| $\frac{a}{b} = 1.5, C = 0.1$ | | | | |
|------------------------------|--------------------|----------------|----------------|----------------|
| Segments | Processing time(S) | Error(%) mode1 | Error(%) mode2 | Error(%) mode3 |
| 18×12 | 0.28 | 0.98 | 0.78 | 0.03 |
| 21×14 | 0.49 | 0.5 | 0.10 | 0.68 |
| 24×16 | 0.78 | 0.7 | 0.45 | 0.47 |
| 27×18 | 1.37 | 0.2 | 0.7 | 0.09 |
| 30×20 | 1.98 | 0.6 | 0.01 | 0.03 |

5 Conclusion

This research revealed the effectiveness of FD method for simulation a flexible thin plate structure utilized in real-time applications. It was shown that FD approach would be a roughly accurate and fast method to anticipate the dynamic behavior of a system with uniform geometry such as plate systems. Although FE method is known to be one of the best numerical methods in computational mechanics, the complexity of the calculations involved in this method makes it slow and inefficient for real-time applications.

Furthermore, for a limited number of sections along the edges (that cause the processing time to be effectively reduced) FD method will estimate more accurate values of the vibration modes compared to FE model. In any case, increasing the number of elements as well as using more complex element types can increase the accuracy of FE prediction against FD method but at the expense of a much slower computation process.

Thus, for the purpose of active vibration control of uniform flexible structures such as plates and beams FD method was proven to be the fastest and most convenient method for real-time design of the controller.

The suitable locations of the sensors on the plate system are the most important considerations in designing an active vibration control system. In order to find the optimal places for the sensors, FE or FD simulations should be carried out. According to the vibration modes to be controlled there will be critical locations on the plate called nodal lines in which the deflections are small. It was shown that the lateral deflections of the plate along the nodal lines are negligible and thus, it results in a poor observation at these positions. Then, it should be avoided to place the sensor in the vicinity of the nodal lines determined by FE or FD simulations.

Acknowledgment

The authors would like to express their gratitude to the *Universiti Teknologi Malaysia (UTM)* and *Ministry of Science, Technology & Innovation (MOSTI)* for their continuous support in the research work. This research was fully supported by a research grant using Vote No. 78197.

References

- [1] I. Z. Mat Darus, and M. O. Tokhi, "Soft computing-based active vibration control of a flexible structure," *Eng. Appl. Artif. Intell.*, Vol. 18, pp. 93-114, 2004.
- [2] A. W. Leissa, *Vibration of plates*, Scientific and Technical Information Division of NASA, NASA SP-160, Washington, D.C.
- [3] K. Maruyama and O. Ichinomiya, "Experimental Study of Free Vibration of Clamped Rectangular Plates with Straight Narrow Slits," *JSME International Journal*, Vol. 32, pp.1871-93, 1989.
- [4] D.J. Gorman, "Free in-plane vibration analysis of rectangular plates by the method of superposition," *Journal of Sound and Vibration*, Vol. 272, pp. 831-851, 2004.
- [5] K.N. Saha, D. Misra, S. Ghosal, G. Pohit, "Nonlinear free vibration analysis of square plates with various boundary conditions," *Journal of Sound and Vibration*, Vol. 287, pp. 1031-1044, 2005.
- [6] Y. Yaman, T. Caliskan, V. Nalbantoglu, E. Prasad, and E. waechter, "Active Vibration Control of a Smart Plate," *ICAS Congress*, 2002.
- [7] M. Tawfik, "A Spectral Finite Element Model For Thin Plate Vibration," *ICSV Congress*, Australia, 2007.
- [8] I. Z. Mat Darus, and M. O. Tokhi, "Dynamic modeling and Simulation of a 2D Structure using finite difference method," in *Inter active2001: IEE International on-line Conference on Active Control of Sound and Vibration*, 2001.
- [9] K. S. Numayr, R. H. Haddad, and M. A. addad, "Free vibration of composite plates using the finite difference method," *Thin-Walled Structures*, Vol. 42, pp. 399-414, 2004.
- [10] S. Timoshenko, and S. Woinowsky-Krieger,

Theory of plates and shells, New York: McGraw Hill, 1959.

- [11] I. Z. Mat Darus, and M. O. Tokhi, "Dynamic modeling and simulation of a flexible rectangular plate structure using finite difference methods," Proceedings of WSEAS International MultiConference, Skiathos Island, Greece, pp. 2521-2526, 2002.
- [12] [T. Schrefl, G. Hrkac, A. Goncharov, J. Dean, S. Bance, M. A. Bashir and D. Suess](#), "Finite element /boundary element simulation of future hard disk recording," Proceedings of the WSEAS International Conference, Applied Computational Conference, ACC '08, Istanbul, Turkey, pp. 430-435, 2008.
- [13] I. Z. Mat Darus, and M. O. Tokhi, "Dynamic modelling and simulation of a flexible rectangular isotropic plate structure using finite difference methods," Advances in Simulation, Systems Theory and Systems Engineering, WSEAS Press, pp. 344-349, 2002.
- [14] [R. D. Blevins](#), *Formulas for natural frequency and mode shape*, New York: Van Nostrand Reinbold, 1979.
- [15] [A. W. Leissa](#), "The Free vibration of Rectangular Plates," *J. Sound and Vibration*, Vol. 31, pp. 257-293, 1973.
- [16] [R. Jones](#), and [B. J. Milne](#), "Application of the Extended antorovich Method to the Vibration of Clamped Rectangular Plates," *J. Sound and Vibration*, Vol. 45, pp. 309-316, 1976.