

Modeling and Analysis of Simplified PV Module with Various Temperature and Irradiance Inputs using MATLAB Simulink Algorithm

Norhaisam Ismail¹, Dalila Mat Said^{1,2*}, Sohrab Mirsaedi³, Nasarudin Ahmad², Norzanah Rosmin^{1,2}, Siti Maherah Hussin^{1,2}, Siti Aisyah Abd Wahid¹, Zaris Izzati Mohd Yassin⁴ and Nur Hazirah Zainal^{1,2}

¹Centre of Electrical Energy Systems, Institute of Future Energy, Universiti Teknologi Malaysia

²Faculty of Electrical Engineering, Universiti Teknologi Malaysia, 81310 UTM Skudai, Johor, Malaysia.

³School of Electrical Engineering, Beijing Jiaotong University, China

⁴School of Engineering & Computing, Manipal International University

*Corresponding author: dalila@utm.my

Abstract: Photovoltaic (PV) systems offer a potential solution to the global energy crisis. Modeling study and analysis involving solar PV module is an important task in PV system to be more user friendly, improve reliability and performance. However, the output characteristics of PV module are nonlinear, since they are dependent on environmental conditions such as solar irradiance and temperature, as well as local climate conditions such as humidity and wind. The various methods used have some common gaps as the absence of step by step procedure which cause difficulties to understand. Indeed, accurate modeling of PV module is important to provide a better understanding of their operation and output characteristics, since simulations can be used to understand the behavior of PV module under various operating conditions. The objective of the project is first, to build and model a solar photovoltaic (PV) module algorithm using Matlab/Simulink. Second, to simulate and analyze behavior of the model in various temperature and irradiance input conditions. Third, to validate the results obtained from the simulations by comparing the output characteristics with the manufacturer's data sheet. The methodology used by presenting the principles of detailed modeling of PV module using Matlab/Simulink software. The constructed model is taken from the equations obtained from the equivalent circuit of a single diode model. The PV Module block is a five-parameter model using a light-generated current source (IL), diode, series resistance (Rs), and shunt resistance (Rsh) to represent the irradiance and temperature dependent I-V and P-V characteristics of the module. This method provides a simple, reliable and highly flexible method to adapt PV module to different environmental conditions such as irradiance, temperature and physical parameters of solar module such as resistance, current, voltage, ideality factors and others. The simulation results and data obtained show that the block module developed and simulated using Matlab/Simulink with various input values of temperature and irradiance is almost identical to the real PV module and user friendly.

Keywords: Modeling of PV module, PV characteristics, temperature and irradiance input, matlab and simulink.

© 2022 Penerbit UTM Press. All rights reserved

Article History: received 18 March 2022; accepted 30 October 2022; published 22 December 2022.

1. INTRODUCTION

The solar industry has expanded rapidly over the last few years, and photovoltaic (PV) systems in particular have increased significantly. The rapid growth is mainly due to the need for alternatives to the fossil-electric fuel generation industry, concerns about the global climate, lower photovoltaic costs and investment in distributed energy resources to improve energy grid efficiency. Solar Road Map IEA estimates that solar PV energy will contribute as well as supply around 11% of global electricity demand by 2050 and will reduce CO₂ emissions by 2.3 gigaton (Gt) per year [1-2].

However, capital costs and maintenance costs of module PV module are still high as they are mostly installed outdoors, where they experience mechanical and electrical stress, resulting in additional power loss, hot spot

formation and various complications on PV module. If the initial steps are not well planned and controlled, the efficiency of the PV module system will be affected and cause the system to be unable to operate fully.

With PV module modeling and analysis project in various temperature and irradiance inputs using matlab / simulink algorithm it can analyze the behavior of the system visually, simulation and even record the data obtained clearly.

This PV module modeling and analysis project is done according to the steps and sequence so that it is more accurate and promises more efficient and effective monitoring and diagnosis of PV module system with various temperature and irradiance inputs taken. In general, this project is related to modeling as well as simulation. For the initial design of a simulation project,

modeling and control algorithms using matlab / simulink programming need to be studied and refined.

2. METHODOLOGY

2.1 Methodology Flowchart

This method needs to be carried out comprehensively and in accordance with the outlined process flow to facilitate data collection to complete the project. Figure 1 shows the flow chart of the projects involved.

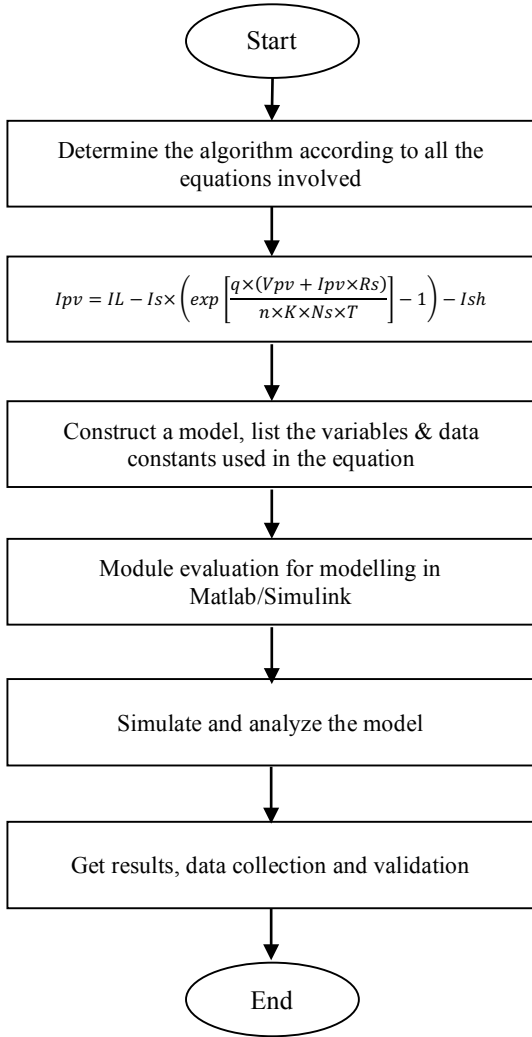

Figure 1. Project flowchart

2.2 Initial Design and Model Development Ideas

Typically, PV solar panels only convert 25% to 40% of the solar irradiance that occurs into electrical energy [3]. From here arose the idea to find, solve and simplify the work process by building models and analyzing circuits from a single diode circuit that has its own advantages.

2.2.1 Models for solar PV cell Module

Due to the non-linear characteristics of I-V solar cells, it is not enough to simply model it as a fixed voltage source or a constant current source. To explain the electrical behavior of these solar cells, single-diode models are most commonly used [4]. The corresponding circuits for the one diode model are shown in figure 2.

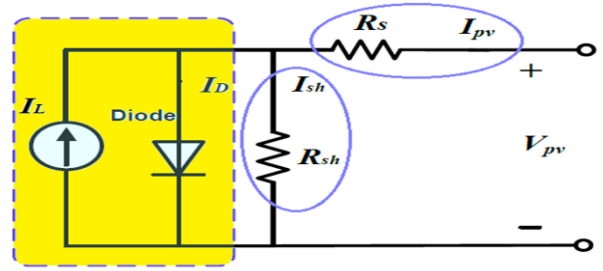

Figure 2. One diode model equivalent circuit

The equation for the Photovoltaic (PV) module, is constructed from the following block algorithm: -

i. Photovoltaic (PV) Current / Output Current (I_{pv}).
For the single diode model (Figure 2), the photovoltaic current / output current (I_{pv}) equation for a PV module is as shown in equation 1.

$$I_{pv} = I_L - I_s \times \left(\exp \left[\frac{q \times (V_{pv} + I_{pv} \times R_s)}{n \times K \times N_s \times T} \right] - 1 \right) - \frac{(V_{pv} + I_{pv} \times R_s)}{R_{sh}} \quad (1)$$

I_L
 I_{sh}

Where:-

- I_L = Light/photo-generated current (A)
- I_D = Diode current (A)
- I_{sh} = Shunt resistance current (A)
- I_S = Saturation current of the diode (A)
- R_s = Series resistance (Ω)
- R_{sh} = Shunt resistance (Ω)
- q = Electron charge = 1.6×10^{-19} C
- k = Boltzmann's constant = 1.38×10^{-23} J/K
- n = Diode ideal factor ($1 \leq n \leq 2$)
- T = Ambient temperature (K)
- N_s = The number of solar cells in series
- I_{pv} = PV module current (A)
- V_{pv} = PV module voltage (V)
- G = Solar irradiance (W/m²)
- G_0 = Reference solar irradiance (W/m²)
- I_{L0} = Reference light generated current (Amp)
- T_0 = Reference temperature (K)
- CT = Temperature coefficient of the light generated current (A/K)

ii. Saturation Current (I_s).
The saturation current (I_s) of a diode, which differs in its temperature, is shown in equation 2.

$$I_s = I_{rs} \times \left[\left(\frac{T}{T_0} \right)^3 * \exp \left[\frac{q * E_g * \left(\frac{1}{T_0} - \frac{1}{T} \right)}{n * K} \right] \right] \quad (2)$$

iii. Reverse Saturation Current (Irs)

Equation 3 shows the reverse saturation current (Irs).

$$Irs = \frac{Isc}{e^{\left(\frac{q*Voc}{n*Ns*K*T}\right)} - 1} \quad (3)$$

iv. Shunt Resistor Current (Ish)

Equation 4 shows the Shunt Resistor Current (Ish).

$$Ish = \left(\frac{Vpv+Ipv*Rs}{Rsh}\right) \quad (4)$$

v. Light / Photo Current (IL)

The light / photo generated current (IL) is defined as depending on solar irradiance and ambient temperature. The equation 5 shows the equation of light / photo current.

$$IL = Isc + ki * (T - 298) * \frac{G}{1000} \quad (5)$$

The I – V model of a single PV cell diode is represented by Equation 1 [4]. Figure 6 depicts the I – V curve, which represents equation 1 and highlights three key points: open circuit voltage (Voc), short-circuit current (Isc), and maximum power point (Pm). According to equation 5 [5], the light/photo current generated in a practical PV cell is dependent on irradiance and temperature.

The diode's saturation current, as indicated by equation 2, is the second parameter in equation I – V. Equation 2 can be simplified by replacing it with equation 3 [5], which shows the saturation current's relationship to temperature in a variety of ways. This update aims to align the model's open-circuit voltage with the data sheet's characteristics, namely (Ki) for a wide range of temperatures.

Resistance in series and parallel are the third and fourth characteristics to consider. The modelling method utilised here selects only one pair (Rs, Rsh) that makes the data sheet peak output power equal to the proposed model's peak output power. Setting Pm yields the link between Rs and Rsh. The ensuing relationship reveals that the two resistances are highly dependent on one another.

Rs and Rsh can be calculated using an iterative procedure that starts with a zero value for Rs and adds until the maximum force of the model matches the maximum force of the experiment. In equation 4 [5], the initial value of Rsh is provided.

The fifth parameter, the diode ideal factor (n), was considered to have a range of n values between 1 and 2 with 0.1 increments. This is a common (n) [6] assumption.

The established model can be enhanced even more by taking into account the effects of Rs and Rsh on light currents, as illustrated in equation 5 [5]. This suggests a substantial relationship when the light current and the short-circuit current have distinct values.

In this project simulation it adopts single diode model for solar cell, because this single diode model has many advantages over double diode model and others: -

- i. For PV module at the device level, this one diode model is accurate enough for fixed condition and fault analysis.
- ii. In the simulation setting, the numerical method for a single diode model accumulates faster than a double diode model.
- iii. For most PV module available on the market, comprehensive one-diode model parameters are available.

2.2.2 Modeling of PV Modules in Each Solar Cell

Simulating each solar cell in a module to model a PV module is impractical. This is because, PV manufacturers will usually only supply to end users complete and environmentally friendly modules and not solar cells in bulk. In addition, in actual working conditions, solar cells packaged in the same module typically have the same light conditions.

It is thus clearly assumed for this reason, that the characteristics and working conditions of all solar cells in each PV module are similar. Therefore, it is very impossible to consider a PV module as a simple unit composed of the same solar cell. Modeling and simulating these PV modules is an important step for normal analysis as well as PV system faults.

At 0.5 V output voltage, a typical PV cell generates less than 2 W. As a result, PV cells in a module are connected in a series-parallel configuration to give sufficient output power and voltage. A photovoltaic array is made up of solar modules that are connected in series and parallel circuits to generate the required current and voltage. The solar module similar circuit with NP parallel and NS series branches is shown in figures 3 and figure 4.

Depending on the semiconductor materials used in PV modules, they are given different values. At ambient temperature, crystal silicon has an Eg value of about 1.12 eV, while Copper Indium Diselenide and Cadmium Telluride have Eg values of 1.03 eV and 1.5 eV, respectively.

For the PV module, the simulation model is made using a single diode model, the modeling algorithm solves it iteratively by using several input parameter currents on a single diode medial circuit to find the algorithm solution (IL-ID) and supply the solution to the source controlled current.

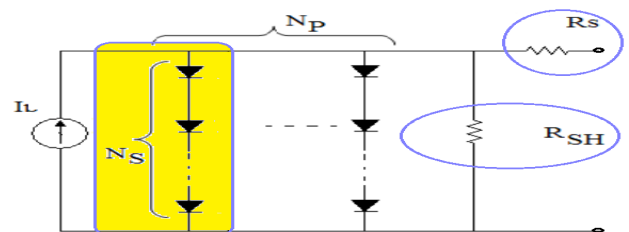

Figure 3. Simplified equivalent circuit PV module model

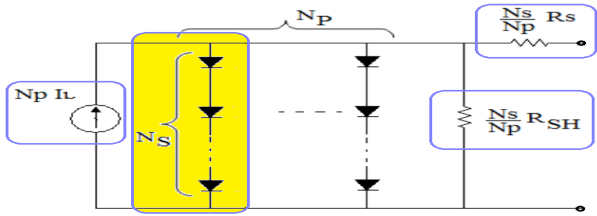

Figure 4. Model of PV module with Ns series cell and Np parallel cell

Figure 5 displays the numerical model for the PV module. There are two inputs for the numerical solution subsystem namely irradiation and also the temperature of the PV module. Other components include a voltage calculation block, a controlled current source and a series and parallel R branches.

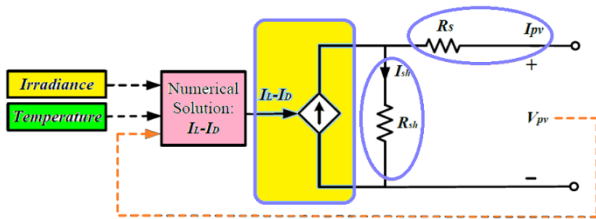

Figure 5. Numerical model for a PV module with 2 input

Ideally, a PV module would have a similar non-linear I-V curve, as seen in figure 6 and figure 7. However, in the actual working environment, the PV module will operate below ambient temperature, significant differences and even in the case of damage, the I-V curve of the PV module will be completely different and the relationship between PV module is difficult to predict.

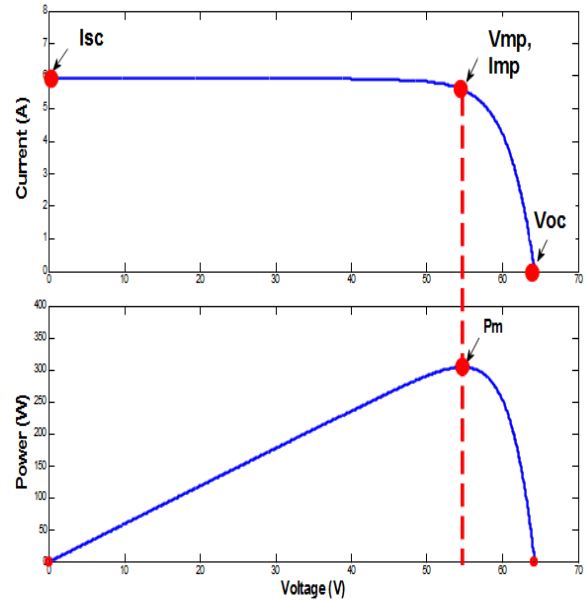

Figure 7. I-V & P-V curve characteristics of PV module

2.2.3 Curve Characteristics Study of I-V & P-V for Solar Photovoltaic

This methodology presents the principles of detailed modeling of photovoltaic (PV) module using matlab/simulink software. The constructed model is taken from the equations obtained from the equivalent circuit of a single diode model. PV module generally consist of various solar cells with similar characteristics. Ideally, a PV module would have a similar non-linear I-V curve, as seen in figure 6. In the actual working environment, the PV module will operate below ambient temperature, these dynamics pose challenges to current PV module simulation strategies.

As shown in figure 6, in three quadrants of its I-V curve, a solar cell exhibits a non-linear output feature. In the 1st quadrant, solar cells produce energy, but lose power in the 2nd and 4th quadrants of the current voltage curve (I-V) as a load. The I-V curve of the solar cell varies with solar irradiance and ambient temperature in the 1st quadrant.

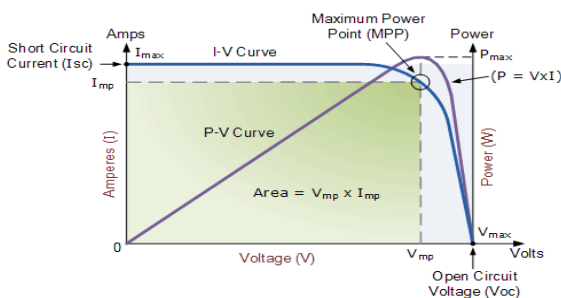

Figure 6. I-V and P-V curve characteristics

2.3 Model Description and Simulation in Matlab /Simulink

A photovoltaic (PV) module is implemented via the PV module block. The module is made up of parallel strings of modules, each string comprising of modules connected in series. This block lets you model both preset PV modules from the National Renewable Energy Laboratory (NREL) System Advisor Model (2018) and custom PV modules.

The PV module block is a five-parameter model that represents the module's irradiance and temperature-dependent I-V and P-V characteristics utilising a light-generated current source (I_L), diode, series resistance (R_s), and shunt resistance (R_{sh}). Figures 3 and 4 illustrate the PV module model, which is made up of a single diode model.

The number of parameters to be modeled is usually (I_s , I_{rs} , I_{sh} , I_L , I_{pv}) as well as the values of R_s and R_{sh} should be taken into reference for a single diode circuit model.

However, some unknown parameters were eliminated in this project to reduce computation time. The photo current and saturation current of the diode are eliminated using a range of measurements taken by the manufacturer under standard test conditions (25°C , $1000\text{W}/\text{m}^2$).

However, in the actual situation these parameters depend on temperature and sunlight, they need to be updated to find the output current in any operating condition.

2.4 Simulation Model Development

In the InitFcn Callback menu in the Simulink Model Properties menu, all fixed parameters for the PV module are set to start the simulation. The numerical solution function block (IL-ID) can be changed by selecting look under mask in the subsystem from the numerical solution menu. In finding numerical solutions, the functional block of algebraic constraints plays an important role in this subsystem. The block limits the $I_L - (I_{pv} + I_D + I_{sh}) = 0$ input signal and emits a V_D diode voltage which, through the feedback direction, affects the input and necessarily limits the zero input.

In the model input windows, the primary parameters for photovoltaic module such as I_{sc} , I_s , V_{oc} and others may be set as constants. This means that the Matlab/Simulink programming model is universal and can be used for any solar PV module as well as making this model as a research tool box as well as a strong design for PV devices. Table 1 shows the module evaluation for modeling in matlab / simulink.

Referring to Table 1, the parameter ($N_s = 54$) is the Number of Cell of the Shenzhen TYSM200 model module made of poly crystalline silicon. Each solar cell can generate 0.5 volts. The 54-cell module can transmit 27 volts. The amount of ampere is determined by the size or area of the cell. The higher the ampere, the bigger the cell. The proposed model is to take solar radiation and temperature as input, while the I-V and P-V parameters as the required output. From the simulation model, the results obtained are matched with the manufacturer's datasheet information. The model has good accuracy and is almost identical to the parameters required in the Standard Test Conditions (STC) in the manufacturer's data sheet.

Other than that, these studies applying the PV module that have power rating 200W rather than another PV module in the market with higher power rating. This is due to consider the existing application that have been used on the software in the parameter model developed using the Matlab/Simulink software. More specifically, the performance of the entire device largely depends on the individually interconnected modules. I-V and P-V curves are suitable for the entire PV module as well as in normal working conditions for Standard Test Conditions (STC). Thus, the objective of matching the I-V and P-V equations as well as V_{mp} , I_{mp} and P_m authentication with various temperature inputs and solar irradiation was successfully achieved.

Table 1. Module evaluation for modeling in matlab / simulink

No	Parameter	Module Rating
1	Maximum power (W)	$P_m = 200 \text{ W}$
2	Maximum power Voltage (V)	$V_{mp} = 26.5 \text{ V}$
3	Maximum power current (A)	$I_{mp} = 7.5 \text{ A}$
4	Open circuit voltage (V)	$V_{oc} = 32.5 \text{ V}$
5	Short circuit current (A)	$I_{sc} = 8.23 \text{ A}$
6	Number per module / cells in series	$N_s = 54$
7	Number of PV module connected in parallel	$N_p = 1$

2.4.1 Working Steps of The Simulation Model

An algorithm model of a PV module involving a current source, series diode, series resistor and parallel is modeled. The PV module simulation is modeled in a matlab/simulink environment. PV modules are modeled according to the step -by -step procedure as follows:

Step 1: Enter the variable and constant parameter values as given in table 2.

Step 2: The Saturation Current (I_s) model as in equation 1, is designed and executes its function according to the model block constructed.

Step 3: The Reverse Saturation Current (I_{rs}) model as in equation 2, is designed and performs its function according to the model block constructed.

Step 4: The Shunt Resistor Current (I_{sh}) model as in equation 3, is designed and performs its function according to the model block constructed.

Step 5: The Light / Photo Current (I_L) model as in equation 4, is designed and performs its function according to the model block constructed.

Step 6: The PV Module / Output Current (I_{pv}) model as in equation 2.5, is designed and performs its function according to the model block constructed.

Step 7: When all the current models as above (5 equations = 5 models) have been built, the PV module models such as projects 1, 2, 3 are completed. Main system model as shown in figure 8, 9, 10.

The results of previous studies show that the matlab / simulink programming model is universal and can be used for any solar PV module as well as making this model a powerful research and design toolbox for PV devices. But there are parameters involved that need to be adapted into the system as constants and variables for the system to function. Table 2 shows a list of variable parameters and constants used.

Table 2. List of variables and data constants used in the equation

No	Parameter	Values of constants and variables
1	Diode saturation current (A)	I_s
2	Reverse saturation current	I_{rs}
3	Shunt resistance current (A)	I_{sh}
4	Light/photo-generated current (A)	I_L
5	PV module current (A)	I_{pv}
6	Short circuit current (A)	I_{sc}
7	Diode current (A)	I_D
8	Short circuit current (Cell 1000W/m ² & 25°C)	$K_i = 0.0032$
9	Ambient / operating temperature (K)	T
10	Nominal temperature (K)	$T_o = 298$
11	Solar Irradiance (W/m ²)	G

12	Electron charge (C)	$q = 1.6 \times 10^{-19} \text{ C}$
13	Diode Ideality factor ($1 \leq n \leq 2$)	$n = 1.039$ ($1 \leq n \leq 2$)
14	Boltzmann's constant (J/K)	$k = 1.38 \times 10^{-23} \text{ J/K}$
15	Semiconductor band gap energy	1.1
16	Series resistance (ohms)	$R_s = 0.351$
17	Shunt resistance (ohms)	$R_{sh} = 137.887$

The PV module simulation is modeled in a matlab / simulink environment. This PV module is modeled according to a step by step procedure involving the equations and parameter values of variables and constants.

2.4.2 Project 1 : The "Main Model" of a combination of five (5) equations governing the characteristics of photovoltaic (PV) module.

The algorithm model system "Main Model" shown in figure 8 has been simulated using matlab / simulink. There are two inputs involved for the algorithm subsystem namely irradiance and temperature inputs.

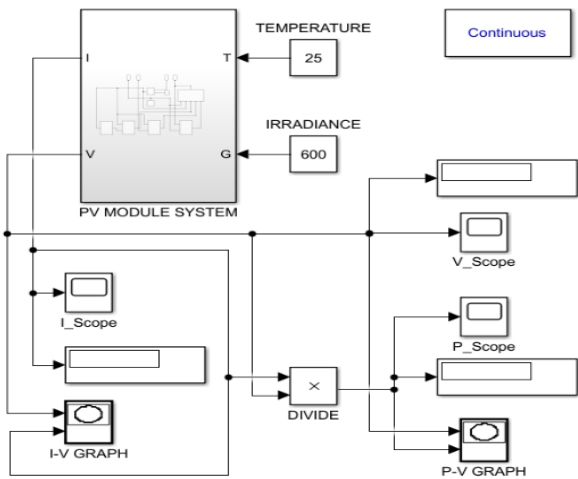

Figure 8. Project 1 "PV module model"

Figure 8 shows a PV module model in matlab / simulink programming, where a virtual subsystem is used as the algorithm solution block. Other components include current, voltage source and series and parallel R branch calculation blocks. This model executes the function given by the equation (Equation 1 - Equation 5).

2.4.3 Project 2: Loads connected to the PV module system model (First Design)

The load connected to the PV module in the matlab / Simulink application is taken from a combination of five (5) previous equation blocks that perform and arrange tasks to meet the characteristics of a photovoltaic (PV) module. The load algorithm model system connected to the PV module system model shown in figure 9 was simulated using matlab / simulink.

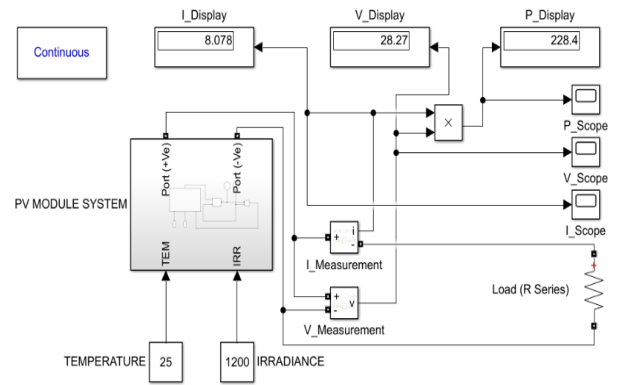

Figure 9. Project 2 "The load connected on PV module system"

Figure 9 shows a PV module model in matlab / simulink programming, where a virtual subsystem is used as the algorithm solution block. Other components include current, voltage source and series and parallel R branch calculation blocks. This model performs the function given by the previous block of equations (Equation 1 - Equation 5).

The Project 2 will generate and record data as well as outputs for Maximum Power Current (I_{mp}), Maximum Power Voltage (V_{mp}) and Maximum Power (P_m) according to constant values and temperature and irradiance input variations generated on the PV model simulation. Data were recorded step by step according to the fixed input data values and the variations tested. It is easier to say that this Project 2 can test and generate the output data one by one according to the input entered.

2.4.4 Project 3: Loads connected to the PV module system model (Second Design)

The load connected to the PV module in the matlab / simulink application is taken from a combination of five (5) previous equation blocks that perform and arrange tasks to meet the characteristics of a photovoltaic (PV) module. The load algorithm model system connected to the PV module system model shown in figure 10 was simulated using matlab / simulink.

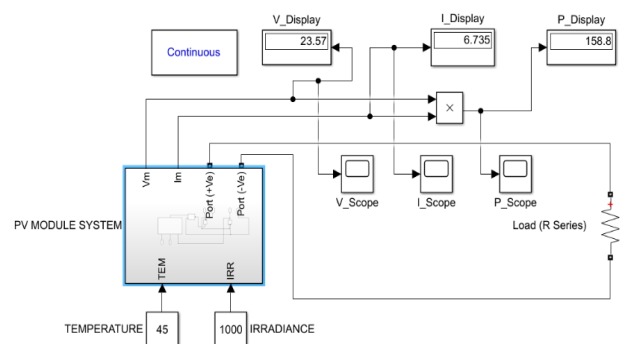

Figure 10. Project 3 "The load connected on PV module system"

Figure 10 shows a PV module model in matlab / simulink programming, where a virtual subsystem is used as the algorithm solution block. Other components include current, voltage source and series and parallel R branch calculation blocks. This model performs the function given

by the previous block of equations (Equation 1 - Equation 5).

This project 3 will generate and record data as well as output for Maximum Power Current (I_{mp}), Maximum Power Voltage (V_{mp}) and Maximum Power (P_m) according to fixed values and temperature and irradiation input variations generated on the PV model simulation. The difference with project model 2 is in the data collection and display of results in combination according to the fixed input data values and the variations tested. In other words that this Project 3 is able to test and produce the output data as a whole according to the input units entered.

3. RESULTS AND DISCUSSION

This section states the results obtained from the implemented project. The results obtained from this project are certainly important for the improvement of existing studies. This section also concludes the studies conducted in the projects involved. The results obtained can support how the methodology created can meet the objectives of this project.

In Matlab/Simulink, a PV photovoltaic system is constructed using the simulation model previously. Each simulation for this model represents a modular and scalable PV module taken from the equations involved. The model tested relies on feedback and has a wide range of input temperatures and irradiance conditions. PV module are usually placed in several series and parallel configurations to create a PV module.

3.1 Data Collection and Analysis

The analysis of these results will involve 3 main projects from the system model as well as the PV module subsystem built. For more detail, each project will display the results and behavior of each project through the I-V and P-V curves as well as the values of Maximum Power Current (I_{mp}), Maximum Power Voltage (V_{mp}) and Maximum Power (P_m) obtained.

3.1.1 Project 1: Data Collection and Analysis of Project Results

This first project focuses more on a combined modeling method of 5 initial equations and will eventually display the characteristics of the I-V and P-V curves from the various temperature and irradiation inputs tested. Table 3 shows the temperature ($^{\circ}C$) variation and irradiance (W/m^2) for curves I-V and P-V.

Table 3. Temperature ($^{\circ}C$) Variation and Irradiance (W/m^2) for Curves I-V and P-V

Irradiance (W/m^2) [Constant]	The Irradiance (Irr) value is taken as 1000 W/m^2					
Temperature ($^{\circ}C$) [Variation]	25 $^{\circ}C$	35 $^{\circ}C$	45 $^{\circ}C$	55 $^{\circ}C$	65 $^{\circ}C$	75 $^{\circ}C$
Temperature ($^{\circ}C$) [Constant]	The Temperature (Tem) value is taken as 25 $^{\circ}C$.					
Irradiance (W/m^2) [Variation]	200 W/m^2	400 W/m^2	600 W/m^2	800 W/m^2	1k W/m^2	1.2k W/m^2

i. Figure 11 and 12 shows the characteristics of the I-V and P-V curves at temperature ($45^{\circ}C$) and irradiation ($1000W/m^2$).

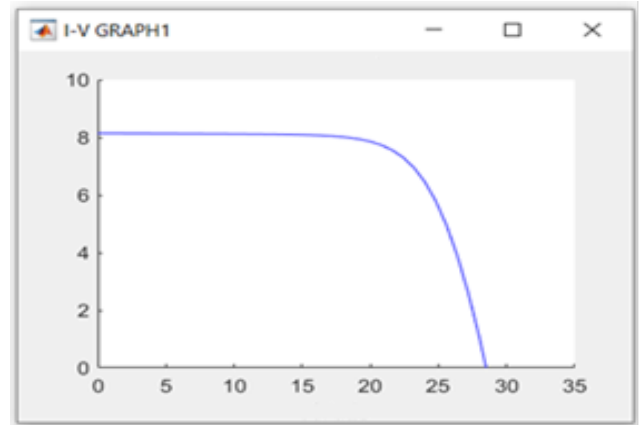

Figure 11. The characteristics of the I-V curve

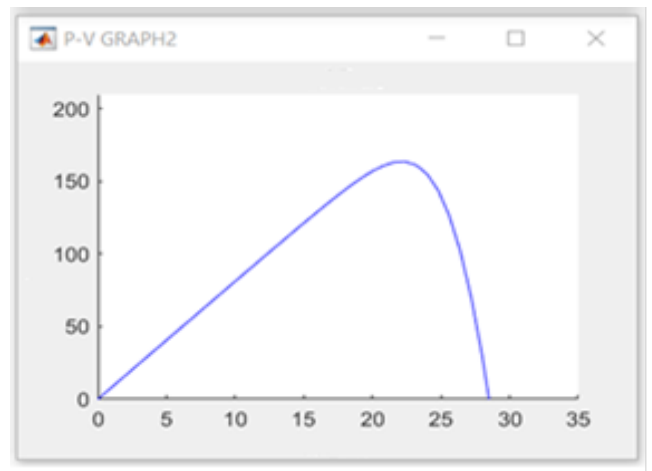

Figure 12. The characteristics of the P-V curve

ii. Figure 13 and 14 shows the characteristics of the I-V and P-V curves at irradiation ($600W/m^2$) and temperature ($25^{\circ}C$).

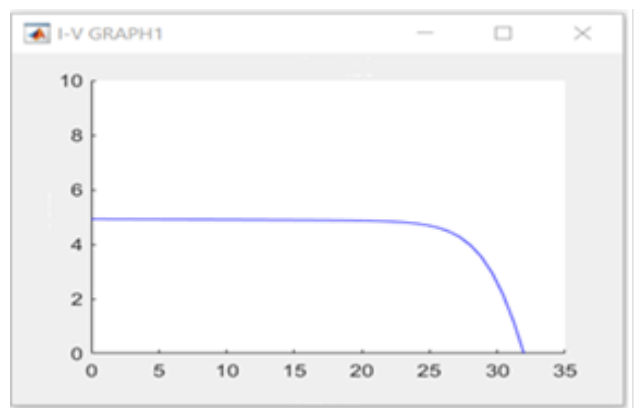

Figure 13. The characteristics of the I-V curve

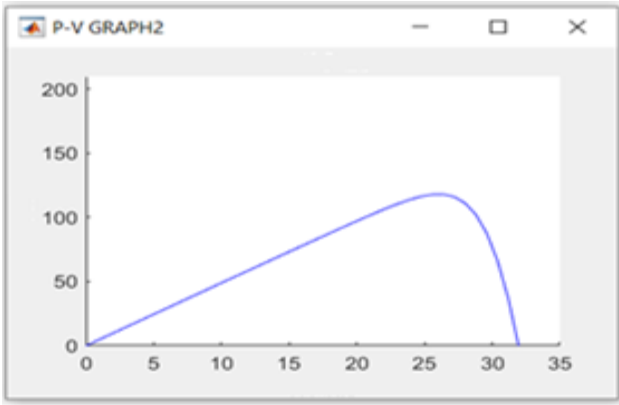

Figure 14. The characteristics of the P-V curve

iii. Project 1 Results Summary

The single diode circuit model developed for the PV module is simulated by Matlab/Simulink which determines the input values of the temperature and its irradiance.

The I-V and P-V characteristics are obtained from models developed for various irradiance and temperature inputs. The irradiance range varies from 200 W/m² to 1200W/m² at a constant temperature of 25°C. In addition, the temperature ranged from 25°C to 75°C with an increase of 25°C at continuous radiance of 1000W/m². The obtained results are used to plot the I-V and P-V curves to ensure that the developed model works well compared to the manufacturer data sheet.

As for the characteristics of I-V and P-V curves under different temperatures and continuous irradiance as shown in (table 3) and (figure 11 and figure 12). Here, the temperature changes from 25°C, 35°C, 45°C, 55°C, 65°C and 75°C with continuous irradiance at 1000W/m². The formula is that when the temperature rises then the solar output current increases slightly but the output voltage decreases drastically. As a result, power output is reduced.

The characteristics of the PV module at the input of irradiance variation and temperature are shown in in (table 3) and (figure 13 and figure 14). In this irradiance the irradiation variations are 200 W/m², 400 W/m², 600 W/m², 800 W/m²,1000W/m² and 1200W/m² with constant temperature at 25°C. The bottom line is that as irradiance increases, the voltage and current of the solar output also increase. As a result, the output power also increases.

3.1.2 Project 2: Data Collection And Analysis Of Project Results

The Project 2 will generate and record data as well as outputs for Maximum Power Current (Imp), Maximum Power Voltage (Vmp) and Maximum Power (Pm) according to constant values and temperature and irradiance input variations generated on the PV model simulation. Data were recorded step by step according to the fixed input data values and the variations tested. It is easier to say that this Project 2 is able to test and generate the output data one by one according to the input entered. This project 2 focuses on the Connected Loads on the PV Module Model System for the Display of Current (Imp), Voltage (Vmp) and Power (Pm) individually according to the input data involved.

i. Table 4 and figure 15 show the output data for the characteristics of the Imp, Vmp & Pm curves for Temperature Variation (75°C) and Irradiance (1000W/m²)

Table 4. Output Table for Temperature Variation (75°C) and Irradiance (1000W/m²)

	Value of R (Ohm)_Ω	I Display (Current A)	V Display (Voltage V)	P Display (Power W)
Temperature Variation (75°C),	1.5 Ω	7.866 A	11.80 V	92.82 W
	2.5 Ω	6.665 A	16.66 V	111.1 W
	3.5 Ω	5.276 A	18.47 V	97.42 W
	4.5 Ω	4.295 A	19.33 V	83.02 W
Irradiance (1000 W/m ²)	5.5 Ω	3.607 A	19.84 V	71.56 W
	6.5 Ω	3.104 A	20.18 V	62.64 W
	7.5 Ω	2.723 A	20.42 V	55.60 W
	8.5 Ω	2.424 A	20.60 V	49.93 W
	9.5 Ω	2.184 A	20.74 V	45.30 W

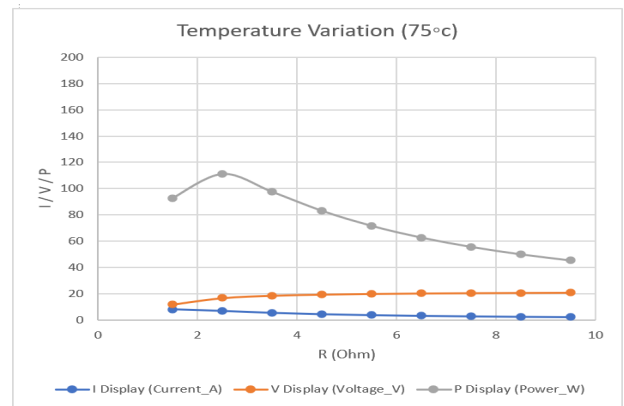

Figure 15. Output Curve Characteristics for Temperature Variation (75°C) and Irradiance (1000W/m²)

ii. Table 5 and figure 16 show the output data for the characteristics of the Imp, Vmp & Pm curves for Irradiance Variation (1200W/m²) and Temperature (25°C)

Table 5. Output Table for Irradiance Variation (1200W/m²) and Temperature (25°C)

	Value of R (Ohm)_Ω	I Display (Current A)	V Display (Voltage V)	P Display (Power W)
Irradiance Variation (1200 W/m ²),	1.5 Ω	9.810 A	14.72 V	144.4 W
	2.5 Ω	9.598 A	23.99 V	230.3 W
	3.5 Ω	8.078 A	28.27 V	228.4 W
	4.5 Ω	6.605 A	29.72 V	196.3 W
Temperature (25°C)	5.5 Ω	5.542 A	30.48 V	168.9 W
	6.5 Ω	4.763 A	30.96 V	147.4 W
	7.5 Ω	4.172 A	31.29 V	130.5 W
	8.5 Ω	3.710 A	31.53 V	117.0 W
	9.5 Ω	3.339 A	31.72 V	105.9 W

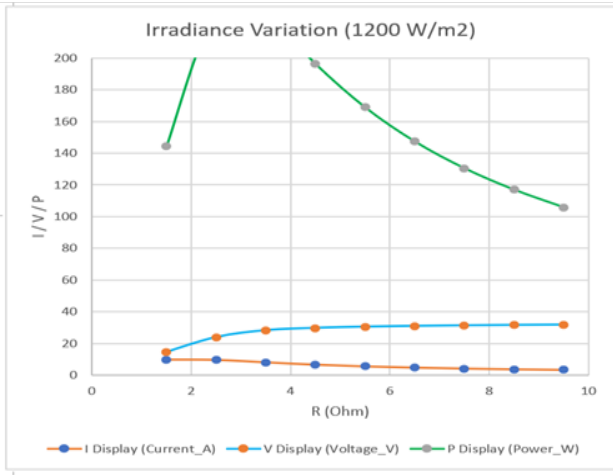

Figure 16. Output Curve Characteristics for Irradiance Variation (1200W/m²) and Temperature (25°C)

iii. Project 2 Results Summary

With this result obtained from project model 2, when we look at the I-V and P-V curves as shown in the figure, it has a very good resemblance to the manufacturer’s data sheet.

This may be explained by the well developed model for this particular module and is very useful for estimating energy production over a given temperature and irradiance range.

When irradiance (characteristics of irradiance variations of 200W/m², 400W/m², 600W/m², 800W/m², and 1000W/m² are given) increases with constant temperature, the voltage and current of the PV output increase, thus increasing the PV output power. Also, for low values of solar irradiance, the I_{sc} short circuit current is reduced but the V_{oc} open circuit voltage change is very less, thus proving that the maximum force from the module decreases.

As for the characteristics of the I_{mp}, V_{mp} and P_{mp} curves under different temperatures and continuous irradiance as shown in figure 15 – figure 16 loads were included. Here, the temperature varies from 25°C, 35°C, 45°C, 55°C, 65°C and 75°C with continuous irradiance at 1000W/m². When the temperature rises then the solar output current increases slightly but the output voltage decreases drastically. As a result, power output is reduced.

3.1.3 Project 3: Data Collection and Analysis Of Project Results

This project 3 will generate and record data as well as output for Maximum Power Current (I_{mp}), Maximum Power Voltage (V_{mp}) and Maximum Power (P_m) according to fixed values and temperature and irradiation input variations generated on the PV model simulation. The difference with project model 2 is in the data collection and display of results in combination according to the fixed input data values and the variations tested. In other words that this Project 3 is able to test and produce the output data as a whole according to the input units entered.

A. The load connected on PV module system model (Temperature variation)

i. Table 6 and figure 17 show the output data for the characteristics of the I_{mp} curves for Temperature Variation and Irradiance (1000W/m²).

Table 6. Current (I_{mp}) Table for Temperature Variation and Irradiance (1000W/m²)

* I Display (Current_A)

Irradiance (1000 W/m ²)	Value of R (Ohm)_Ω	Temperature Variation (25-c) *Current A	Temperature Variation (35-c) *Current A	Temperature Variation (45-c) *Current A	Temperature Variation (55-c) *Current A	Temperature Variation (65-c) *Current A	Temperature Variation (75-c) *Current A
	1.5 Ω	8.176 A	8.143 A	8.108 A	8.065 A	7.998 A	7.866 A
2.5 Ω	8.136 A	8.052 A	7.887 A	7.595 A	7.178 A	6.665 A	
3.5 Ω	7.559 A	7.171 A	6.735 A	6.268 A	5.779 A	5.276 A	
4.5 Ω	6.380 A	5.975 A	5.563 A	5.145 A	4.722 A	4.295 A	
5.5 Ω	5.404 A	5.048 A	4.691 A	4.331 A	3.970 A	3.607 A	
6.5 Ω	4.664 A	4.354 A	4.043 A	3.731 A	3.418 A	3.104 A	
7.5 Ω	4.095 A	3.822 A	3.548 A	3.273 A	2.998 A	2.723 A	
8.5 Ω	3.647 A	3.404 A	3.159 A	2.915 A	2.669 A	2.424 A	
9.5 Ω	3.287 A	3.067 A	2.847 A	2.626 A	2.405 A	2.184 A	

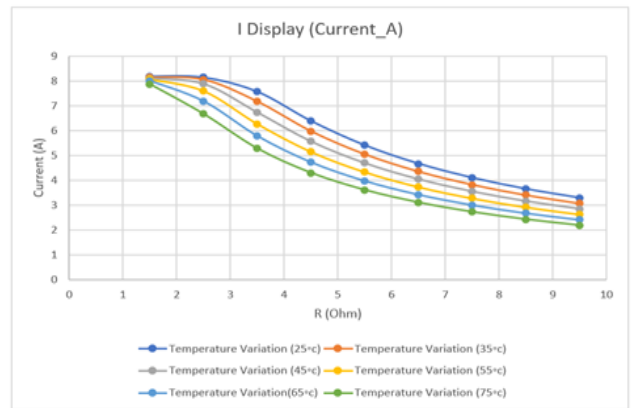

Figure 17. Current (I_{mp}) Curve Characteristics for Temperature Variation and Irradiance (1000W/m²)

ii. Table 7 and figure 18 show the output data for the characteristics of the V_{mp} curves for Temperature Variation and Irradiance (1000W/m²)

Table 7. Voltage (V_{mp}) Table for Temperature Variation and Irradiance (1000W/m²)

* V Display (Voltage_V)

Irradiance (1000 W/m ²)	Value of R (Ohm)_Ω	Temperature Variation (25-c) *Voltage V	Temperature Variation (35-c) *Voltage V	Temperature Variation (45-c) *Voltage V	Temperature Variation (55-c) *Voltage V	Temperature Variation (65-c) *Voltage V	Temperature Variation (75-c) *Voltage V
	1.5 Ω	12.26 V	12.21 V	12.16 V	12.10 V	12.00 V	11.80 V
2.5 Ω	20.34 V	20.13 V	19.72 V	18.99 V	17.94 V	16.66 V	
3.5 Ω	26.46 V	25.10 V	23.57 V	21.94 V	20.23 V	18.47 V	
4.5 Ω	28.71 V	26.89 V	25.03 V	23.15 V	21.25 V	19.33 V	
5.5 Ω	29.72 V	27.77 V	25.80 V	23.82 V	21.83 V	19.84 V	
6.5 Ω	30.32 V	28.30 V	26.28 V	24.25 V	22.22 V	20.18 V	
7.5 Ω	30.71 V	28.66 V	26.61 V	24.55 V	22.49 V	20.42 V	
8.5 Ω	31.00 V	28.93 V	26.85 V	24.77 V	22.69 V	20.60 V	
9.5 Ω	31.22 V	29.13 V	27.04 V	24.95 V	22.85 V	20.74 V	

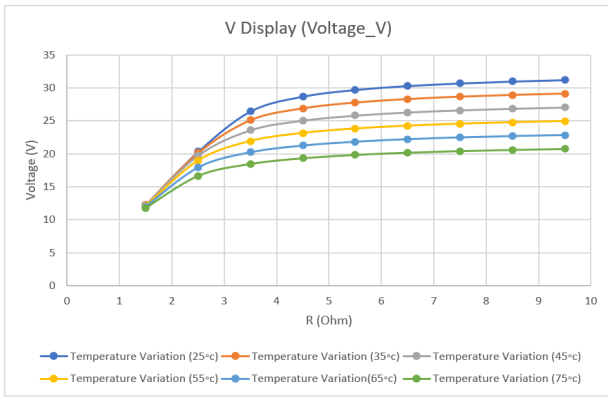

Figure 18. Voltage (Vmp) Curve Characteristics for Temperature Variation and Irradiance (1000W/m2)

iii. Table 8 and figure 19 show the output data for the characteristics of the Pm curves for Temperature Variation and Irradiance (1000W/m2)

Table 8. Power (Pm) Table for Temperature Variation and Irradiance (1000W/m2)

*P Display (Power_W)

Irradiance (1000 W/m2)	Value of R (Ohm)_Ω	Temperature Variation (25-c) *Power_W	Temperature Variation (35-c) *Power_W	Temperature Variation (45-c) *Power_W	Temperature Variation (55-c) *Power_W	Temperature Variation (65-c) *Power_W	Temperature Variation (75-c) *Power_W
	1.5 Ω	100.3 W	99.47 W	98.61 W	97.57 W	95.94 W	92.82 W
2.5 Ω	165.5 W	162.1 W	155.5 W	144.2 W	128.8 W	111.1 W	
3.5 Ω	200.0 W	180.0 W	158.8 W	137.5 W	116.9 W	97.42 W	
4.5 Ω	183.2 W	160.7 W	139.3 W	119.1 W	100.3 W	83.02 W	
5.5 Ω	160.6 W	140.2 W	121.0 W	103.2 W	86.68 W	71.56 W	
6.5 Ω	141.4 W	123.2 W	106.2 W	90.47 W	75.93 W	62.64 W	
7.5 Ω	125.8 W	109.6 W	94.41 W	80.37 W	67.42 W	55.60 W	
8.5 Ω	113.1 W	98.47 W	84.84 W	72.21 W	60.57 W	49.93 W	
9.5 Ω	102.6 W	89.35 W	76.98 W	65.51 W	54.94 W	45.30 W	

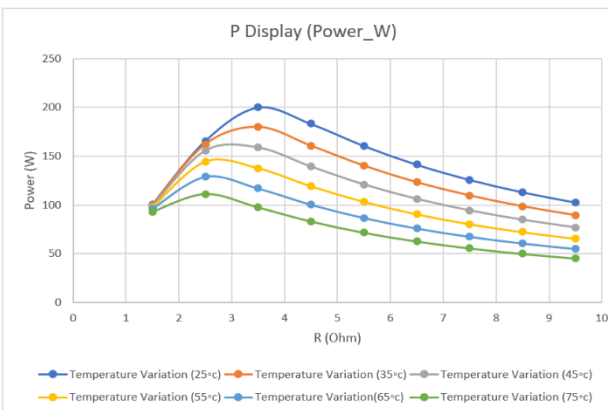

Figure 19. Power (Pm) Curve Characteristics for Temperature Variation and Irradiance (1000W/m2)

B. The load connected on pv module system model (Irradiance variation)

i. Table 9 and figure 19 show the output data for the characteristics of the Imp curves for Irradiance Variation and Temperature (25°C)

Table 9. Current (Imp) Table for Irradiance Variation and Temperature (25°C)

*I Display (Current_A)

Temperature (25-c)	Value of R (Ohm)_Ω	Irradiance Variation (200 W/m2) *Current_A	Irradiance Variation (400 W/m2) *Current_A	Irradiance Variation (600 W/m2) *Current_A	Irradiance Variation (800 W/m2) *Current_A	Irradiance Variation (1000 W/m2) *Current_A	Irradiance Variation (1200 W/m2) *Current_A
	1.5 Ω	1.635 A	3.270 A	4.906 A	6.541 A	8.176 A	9.810 A
2.5 Ω	1.631 A	3.263 A	4.894 A	6.523 A	8.136 A	9.598 A	
3.5 Ω	1.627 A	3.255 A	4.880 A	6.451 A	7.559 A	8.078 A	
4.5 Ω	1.624 A	3.247 A	4.840 A	5.942 A	6.380 A	6.605 A	
5.5 Ω	1.620 A	3.237 A	4.628 A	5.175 A	5.404 A	5.542 A	
6.5 Ω	1.616 A	3.216 A	4.212 A	4.513 A	4.664 A	4.763 A	
7.5 Ω	1.612 A	3.154 A	3.785 A	3.984 A	4.095 A	4.172 A	
8.5 Ω	1.608 A	3.012 A	3.413 A	3.560 A	3.647 A	3.710 A	
9.5 Ω	1.604 A	2.822 A	3.098 A	3.214 A	3.287 A	3.339 A	

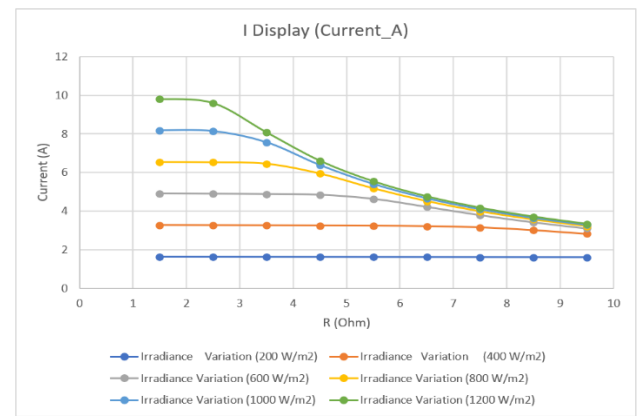

Figure 19. Current (Imp) Curves Characteristics for Irradiance Variation and Temperature (25°C)

ii. Table 10 and figure 20 show the output data for the characteristics of the Vmp curves for Irradiance Variation and Temperature (25°C)

Table 10. Voltage (Vmp) Table for Irradiance Variation and Temperature (25°C)

*V Display (Voltage_V)

Temperature (25-c)	Value of R (Ohm)_Ω	Irradiance Variation (200 W/m2) *Voltage_V	Irradiance Variation (400 W/m2) *Voltage_V	Irradiance Variation (600 W/m2) *Voltage_V	Irradiance Variation (800 W/m2) *Voltage_V	Irradiance Variation (1000 W/m2) *Voltage_V	Irradiance Variation (1200 W/m2) *Voltage_V
	1.5 Ω	2.453 V	4.906 V	7.358 V	9.811 V	12.26 V	14.72 V
2.5 Ω	4.078 V	8.157 V	12.23 V	16.31 V	20.34 V	23.99 V	
3.5 Ω	5.696 V	11.39 V	17.08 V	22.58 V	26.46 V	28.27 V	
4.5 Ω	7.306 V	14.61 V	21.78 V	26.74 V	28.71 V	29.72 V	
5.5 Ω	8.908 V	17.80 V	25.46 V	28.46 V	29.72 V	30.48 V	
6.5 Ω	10.50 V	20.91 V	27.38 V	29.34 V	30.32 V	30.96 V	
7.5 Ω	12.09 V	23.65 V	28.39 V	29.88 V	30.71 V	31.29 V	
8.5 Ω	13.67 V	25.61 V	29.01 V	30.26 V	31.00 V	31.53 V	
9.5 Ω	15.24 V	26.81 V	29.43 V	30.53 V	31.22 V	31.72 V	

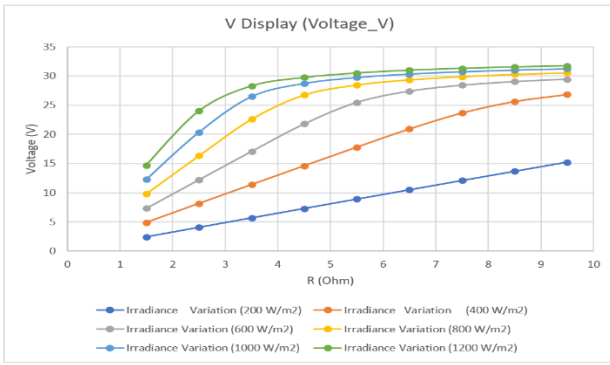

Figure 20. Voltage (Vmp) Curve Characteristics for Irradiance Variation and Temperature (25°C)

iii . Table 11 and figure 21 show the output data for the characteristics of the Pm curves for Irradiance Variation and Temperature (25°C)

Table 11. Power (Pm) Table for Irradiance Variation and Temperature (25°C)

*P Display (Power_W)

	Value of R (Ohm)_Ω	Irradiance Variation (200 W/m²) *Power_W	Irradiance Variation (400 W/m²) *Power_W	Irradiance Variation (600 W/m²) *Power_W	Irradiance Variation (800 W/m²) *Power_W	Irradiance Variation (1000 W/m²) *Power_W	Irradiance Variation (1200 W/m²) *Power_W
Temperature (25°C)	1.5 Ω	4.011 W	16.04 W	36.10 W	64.17 W	100.3 W	144.4 W
	2.5 Ω	6.653 W	26.61 W	59.87 W	106.4 W	165.5 W	230.3 W
	3.5 Ω	9.270 W	37.08 W	83.35 W	145.7 W	200.0 W	228.4 W
	4.5 Ω	11.86 W	47.43 W	105.4 W	158.9 W	183.2 W	196.3 W
	5.5 Ω	14.43 W	57.62 W	117.8 W	147.3 W	160.6 W	168.9 W
	6.5 Ω	16.97 W	67.23 W	115.3 W	132.4 W	141.4 W	147.4 W
	7.5 Ω	19.49 W	74.59 W	107.4 W	119.1 W	125.8 W	130.5 W
	8.5 Ω	21.98 W	77.13 W	98.99 W	107.7 W	113.1 W	117.0 W
	9.5 Ω	24.44 W	75.64 W	91.18 W	98.14 W	102.6 W	105.9 W

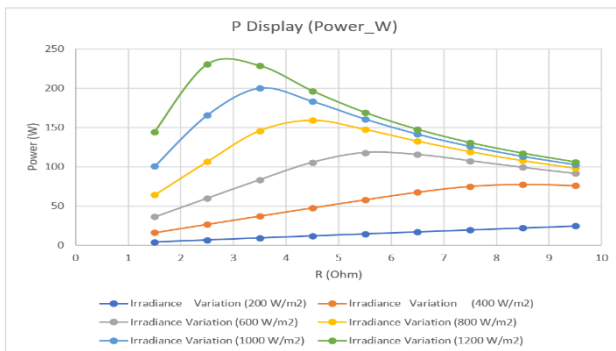

Figure 21. Power (Pm) Curve Characteristics for Irradiance Variation and Temperature (25°C)

C. Project 3 Results Summary

With this simulation model, the PV characteristics of the module are obtained. These characteristics are obtained by varying the variation of temperature and irradiance parameters.

These results are obtained from project model 3, and from the analysis made, as a whole when the required output values are collected and displayed simultaneously it shows a clear understanding and behavior of the output Voltage (Vmp), current (Imp) and maximum power (Pm)

produced. The results obtained are similar to the data and characteristics of the curves generated in project 3.

As the temperature increases with continuous irradiance, the Isc short -circuit current increases, as the tape gap energy decreases and more photons have enough energy to form electron hole pairs. The increase in temperature has a clear reduction in the output power of the PV module due to a decrease in the Voc open circuit voltage, thus reducing the efficiency of the PV module.

The characteristics of the PV module at the variation input and light temperature are shown in (figure 19 - 21). At these irradiation variations are 200W/m², 400W/m², 600W/m², 800W/m², 1000W/m² and 1200W/m² with constant temperature at 25°C. In this case the characteristics at the outputs of Imp, Vmp and Pm also change with the input load factor. As the irradiation increases, the voltage and current of the solar output also increase. As a result, the output power also increases.

3.2 Data Validation Results

To validate the PV model simulated using matlab/simulink, commercial PV module on the market were compared with manufacturer’s data sheets.

3.2.1 Model Validation for PV Module

The module involved is the Shenzhen TYSM200 which is made of poly-crystalline silicon. The manufacturer module data sheet parameters in STC for a 200 Watt PV module are almost identical to the model parameters developed using matlab/simulink simulations.

More specifically, the overall performance of the device is highly dependent on individually interconnected modules. The I-V and P-V curves are suitable for the entire PV module as well as in normal working conditions in STC. The model parameters compared to the manufacturer module data sheet are almost identical to the model parameters developed using matlab/simulink simulations. Table 12 shows the validation of model parameters was compared with the manufacturer module data sheet with model parameters developed using matlab/simulink simulations.

Table 12. The validation of model parameters was compared with the manufacturer module data sheet with model parameters developed using matlab / simulink simulations.

Bil	Parameters	Equipment / Module	
		Module Evaluation (Modeling In Matlab / Simulink)	Shenzhen TYSM200 Module, At STC
1	Maximum Power Pm(W)	200W	200W
2	Maximum Power Voltage Vmp(V)	26.5V	27V
3	Maximum Power Current Imp(A)	7.5A	7.5A
4	Open Circuit Voltage Voc(V)	32.5V	32.5V
5	Short Circuit Current Isc(A)	8.23A	8.23A
6	Number Per Module / Cells In Series	54	54

4. CONCLUSION

The modeling method through the algorithm displaying the simulation results of the PV module can be presented well. This method provides a simple, reliable and highly flexible method to adapt PV modules to different environmental conditions such as irradiation, temperature and physical parameters of solar modules such as resistance, current, voltage, ideality factors and others.

The differential characteristics of the curve can be developed using a simulation model. The results obtained show that this model has good accuracy and is almost identical to the manufacturer's data sheets required in obtaining the I-V and P-V curves. With this, all the objectives compiled and developed can be implemented successfully according to the methods and activities that have been done. Therefore, the objectives stated in this project have been achieved and the hypotheses have been confirmed.

ACKNOWLEDGEMENTS

The authors would like to express the appreciation to the Ministry of Higher Education Malaysia (MOHE), the support of the sponsors [Vot Number: Q.J130000.3551.07G53] and to the Universiti Teknologi Malaysia (UTM) for providing the best education and research facilities to achieve the aims and goals in the research studies and works.

REFERENCES

- [1] Toward a World-Class Energy Sector, Energy Malaysia, Volume 18, 2019, www.st.gov.my
- [2] IEA, "Technology Roadmap Solar photovoltaic energy," International Energy Agency, 2010.
- [3] Dikio C. Idoniboyeobu, Sunny Orike, Sopakiriba M. West, "Evaluation and Implementation of Maximum Power Point Tracking (MPPT) on a Stand-Alone Power Based Solar Panel", Department of Electrical Engineering, Rivers State University, Nigeria, GSJ Vol. 8, p-p 466-478, 2020.
- [4] Aarti Gupta, Anula Khare and Amit Shrivastava, "Modeling of Solar Photovoltaic Module and Effect Of Variation Of Insolation Using Matlab/Simulink", 2014.
- [5] M. G. Villalva, J. R. Gazoli, and E. R. Filho, "Comprehensive Approach to Modeling and Simulation of Photovoltaic Arrays", Power Electronics, IEEE Transactions on, vol. 24, pp. 1198-1208, 2009.
- [6] P Mialhe et. al, "The diode quality factor of solar cells under illumination" Journal of Physics D: Applied Physics vol. 19, NO. 3, 1986.
- [7] Afshan Ilyas, M. Rizwan Khan, Mohammad Ayyub, Mirza Tabish Shah Beg, "Modelling and Study of SPV Module under Partial Shading Condition with Simulation and Experimental Results", 7th International Conference on Signal Processing and Integrated Networks (SPIN), p-p 399-404, 2020.
- [8] Nur Sarma, Keziban Gegin, Mehmet Şimşir, Nedim Tutkun, "Modeling of a Typical Photovoltaic Module using Matlab/Simulink", IEEE Journal, p-p 1-6, 2018.
- [9] Nupur Yadav, D.K. Sambariya, "Mathematical Modelling and Simulation of Photovoltaic Module using Matlab/ Simulink", IEEE Journal, p-p 1-6, 2018.
- [10] Kamal Keshavani, Jigar Joshi, Vishrut Trivedi, Mitesh Bhavsar, "Modelling and Simulation of Photovoltaic Module Using Matlab/ Simulink". International Journal of Engineering Development and Research, p-p 1-10, 2014.
- [11] Vandana Khanna, Bijoy Kishore Das, Dinesh Bisht, "Matlab/Simelectronics Models Based Study of Solar Cells", international journal of renewable energy research, p-p 1-5, 2013
- [12] Divine Atsu ab, Alok Dhaundiya, "Modeling Of Photovoltaic Module Using The Matlab", Journal Of Natural Resources And Development, p-p 1-12, 2019.
- [13] Amevi Acakpovi, Essel Ben Hagan, "Novel Photovoltaic Module Modeling Using Matlab/Simulink", 2013.
- [14] R.Ayaz,I.Nakir,andM.Tanrioven, "An Improved Matlab-Simulink Model Of PV Module Considering Ambient Conditions", 2014.
- [15] Silvano Vergura, "A Complete And Simplified Datasheet-Based Model Of PV Cells In Variable Environmental Conditions For Circuit Simulation", 2016.
- [16] Ahmed Jumui Sumoi Fomba1, Hermawan , Trias Andromeda, Mochammad Facta, And Iwan Setiawan, "Simulation Of Grid-Tied Photovoltaic System Based On Solar Irradiance And Temperature Data In Semarang.", 2019.
- [17] W. Shen, H. Choo Fook, P. Wang, C. Loh Poh, and Y. Khoo Sui, "Development of a mathematical model for solar module in photovoltaic systems," in Industrial Electronics and Applications (ICIEA), 2011 6th IEEE Conference on, 2011, 2056-2061.
- [18] MATLAB Solution Provider. MATLAB Online courses and Projects in the following areas: Renewable Energy Systems, Power Systems, Digital Image Processing, in MATLAB, ARDUINO coding in MATLAB etc, 2021.
- [19] Krismadinata, Nasrudin Abd. Rahim, Hew Wooi Ping, Jeyraj Selvaraj, "Photovoltaic module modeling using simulink/matlab", 2015.
- [20] NFPA70, "Article 690 - Solar Photovoltaic Systems of National Electrical Code," ed, 2011.
- [21] W. Bower and J. Wiles, "Investigation of ground-fault protection devices for photovoltaic power system applications," in Photovoltaic Specialists Conference, 2000.
- [22] S. K. Firth, K. J. Lomas, and S. J. Rees, "A simple model of PV system performance and its use in fault detection," Elsevier - solar energy, 2009.
- [23] W. Chine, A. Mellit, A. Massi Pavan V. Lugh, "Fault diagnosis in photovoltaic arrays", 2018.