

Design of Sub-Systems for GPS-Guided Autonomous Delivery Robot System

Mohd Ariffanan Mohd Basri* and Nur Hayati Sahrir

Faculty of Electrical Engineering, Universiti Teknologi Malaysia, UTM, 81310, Skudai, Johor Bahru, Malaysia

*Corresponding author: ariffanan@fke.utm.my

Abstract: The use of autonomous robots for delivery services is a new potential goldmine. Furthermore, since the e-commerce and delivery industry are growing at a rapid rate, it is recommended that a system that could handle the high-volume traffic as well serve as a new customer attraction, be implemented. Therefore, this work aims to develop the Autonomous Delivery Robot System (ADRS) that could be utilized for delivery services from the early stage of development. The ADRS uses the Arduino microcontroller to run a program. The developed system consists of three main sub-systems, namely, mobile robot, mobile application and cloud server. The mobile robot is equipped with features such as navigation system, obstacle detection system, container lock system and real-time monitoring system to maneuver it autonomously. The ultrasonic sensors are used for obstacle detection, coupled with a Global Positioning System (GPS) for the navigation purpose. The ADRS ensures a human-contactless and secure delivery while carry the delivery packages. Only the customer can unlock the container using the one-step authentication via mobile application. A camera is also attached on the robot for real-time monitoring purpose. The mobile application with customized map based on Google Maps is created to provide the user with a useful interface. The cloud server acted as the intermediate for data transfer and receive between the mobile robot and the mobile application. This paper discusses the three main sub-systems and the performance of each feature of the mobile robot has been evaluated separately.

Keywords: GPS Navigation, Mobile Robot, Mobile Application

© 2022 Penerbit UTM Press. All rights reserved

Article History: received 11 October 2021; accepted 3 December 2022; published 22 December 2022.

1. INTRODUCTION

Since the Covid-19 pandemic outbreak started, there have been so many researches and approaches taken to help people to adapting in the new norm situation. One of the approaches is automizing delivery system without any human intervention which eventually prevents any close contact between humans. Autonomous navigation is widely being used with different methods or techniques being implemented to drive a robot vehicle from one place to a targeted destination, safely and independently. A robot vehicle is electrically-powered and it does not require any fuel to work. This will help to reduce the usage of current and conventional delivery system which uses fueled vehicles and then, reduces the air pollution that is caused by the releasing of carbon monoxide gases from those vehicles. As these robots must share space with other moving vehicles or people, suburbs and places with minimal traffic are their preferred operating areas.

GPS-based autonomous navigation approach is being used in this work which the localization information is obtained from a cluster of satellites and its heading towards a new coordinate is calculated. The basic concept of this work is to navigate the ADRS from its current location to the user's location. The main objective of this work is to develop a complete autonomous delivery robot system

which consists of three main components (sub-systems), namely, mobile robot, mobile application and cloud server. In this paper, the description and performance of each sub-system are presented.

2. RELATED WORK

Autonomous robotic systems offer the potential for significant enhancements in safety and operational efficiency. Due to the meteoric growth of e-commerce, developing faster, more affordable and sustainable last-mile deliveries become more important. Many challenges like reduced capacity, driver shortage, damaged and stolen products, failed delivery attempts, increased traffic congestion, etc. can be solved using autonomous robots. An autonomous robot is designed and engineered to deal with its environment on its own, and work for extended periods of time without human intervention. It must not only carry out its task of delivery properly but must also consider the various scenarios changing around it and act accordingly. The robot must make quick decisions even in adverse conditions, considering the safety of pedestrians around it [1]. The aim of autonomous robots is to work alongside humans and try to make human life easier.

Currently, many robots are being used in industries [2], homes [3], military applications, disaster management [4],

etc., all around the world. The advancements in robotics have made lives easier for humans in many aspects and it provides with a safer and more efficient alternative to perform tasks which are difficult or time consuming for humans. Some of the applications of autonomous robots include cleaning robots like Roomba, delivery robots, autonomous vehicles, and other robots that move freely around a physical space without being guided by humans [5].

With technological advances, the increased accuracy of robots, and a desire for convenience and the reduction of manpower, robots are a novel solution for the purpose of delivery. For example, a prototype robot has been designed for frequent mail delivery from the central office to individuals [6]. Additionally, in the healthcare industry, multiple robots have been employed for hospital logistics [7]. One such application, robots have been designed to support the nursing staff by delivering medical kits as well as information packages [8].

There are numerous researches on service delivery applications of robot. For instance, warehouse navigation robot and food service system robot based on the ‘line following system’ were designed and implemented [9]. Another application of line following robot is the library inventory management system (LIMS) designed to search through books on a rack and select the required one [10]. Majority of mobile robots used for food delivery operate on the basic principle of line following. Line following is based on Infrared Photoelectric (IR) technology. An IR sensor is used to ensure that the robot moves by tracking a line of white colour on a black surface or a black colour on a white surface.

Mobile robot should navigate through desire route and avoid the obstacle within the path. Many researchers come with the solution by using the various type of control and instrumentation system. Researchers have implemented positioning [11-15] and avoidance obstacle [16-19] methods to plan the path of the autonomous robot.

3. DESIGN OF AUTONOMOUS DELIVERY ROBOT SYSTEM (ADRS)

The chosen techniques and other sub-systems are explained in detail in this section.

3.1 Mobile Robot Sub-System

GPS Navigation

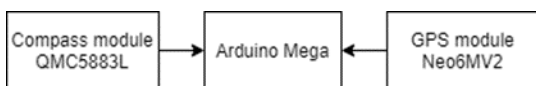

Figure 1. Block Diagram Architecture for GPS Navigation

The block diagram for GPS navigation is shown in Figure 1. Both GPS module and compass module play different role but contributes towards the precision of navigation process. GPS module will provide the localization information of the robot for every 1s. The compass module will constantly provide the robot’s heading to Arduino Mega. Then, the robot’s pose will also

constantly being computed in Arduino Mega as the master controller and corrected by adjusting the motor until it reaches the next fixed coordinate and the process repeats until the robot reaches the final coordinate in the set.

In this work, the information provided by both compass and GPS module, which is the robot’s localization, is updated online for every 10s. This feature has yet to accomplish its full function to navigate from one location to another location.

Container Lock System

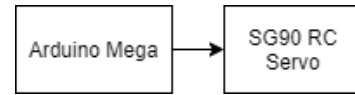

Figure 2. Block Diagram Architecture for Container Lock System

At the end of the process, the mobile application will receive an ‘open door’ command from the user to unlock the container of the mobile robot. This is to ensure that the customer will receive his orders perfectly. Figure 2 shows the simple block diagram of locking system. This feature is to make sure that the orders are delivered safely and to avoid theft. Signals are sent from Firebase to determine the door lock or unlock. Signal ‘1’ to unlock the door will be sent when; 1. The customer confirms his orders and 2. The customer clicks ‘Unlock Door’ from the app. While, signal ‘0’ to lock the door will be sent when; 1. 30 seconds after the robot starts to navigate and 2. The customer clicks ‘Quit App’ from the app. It can only be unlocked by the ordering user from the mobile application once the robot has arrived at the final waypoint which is the current location of the user. An RC servo is used as the door lock mechanism. In this work, the command from the user is yet to function but the mechanism is finished.

Obstacle Avoidance

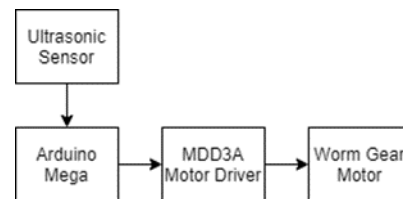

Figure 3. Block Diagram Architecture for Obstacle Avoidance

Figure 3 shows the block diagram for obstacle avoidance. There are three ultrasonic sensors installed on the robot; front side, left side, and right side. The front and right sides are meant for obstacle avoidance while the left side is to make sure that the robot will always maintain a distance of 10 cm with the left side bar of the road. The front and right sensors are kept at above 40cm of threshold to ensure the safety of the robot during navigation. If it is below threshold, the robot will stop. This feature will always take place during the navigation process. The action plan for obstacle avoidance is shown in Table 1.

Table 1. Obstacle Avoidance Action Plan

LEFT	FRONT	RIGHT	ACTION
= 10	>Threshold	x	Forward
= 10	>Threshold	<Threshold	Stop
>10	>Threshold	x	Left then Forward
>10	>Threshold	<Threshold	Stop
<10	>Threshold	x	Right then Forward
<10	>Threshold	<Threshold	Stop
x	<Threshold	x	Stop then Right
x	>Threshold	x	Forward then Left
x	<Threshold	x	Stop



Figure 6. Final Robot Design

Real Time Monitoring

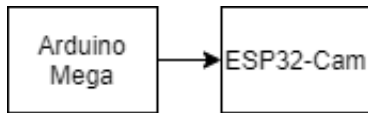

Figure 4. Block Diagram Architecture for Real-Time Monitoring

Figure 4 shows the simple block diagram of ESP32-Camera. The camera is attached at the front side of the robot and can send a real-time video for monitoring purpose. This is an added advantage to ensure the robot safety from theft. The developer can always monitor the autonomous robot operation remotely without any help from human. The camera can only connect to the internet which the SSID and password has been set in the coding. Figure 5 depicts the real-time monitoring viewed from the browser.

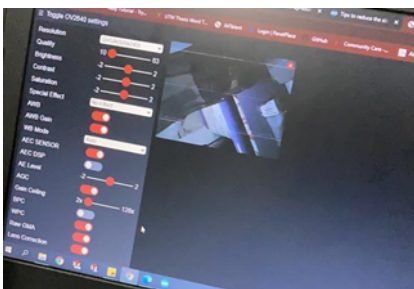

Figure 5. Interface for Real-Time Monitoring

Hardware Parts of the Robot

Figure 6 shows the final robot design that was developed part by part.

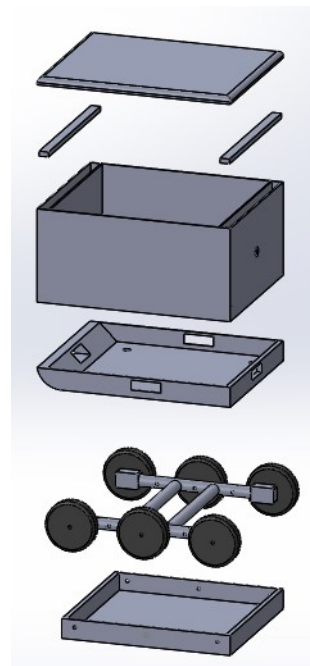

Figure 7. Exploded View of Robot Vehicle

Based on Figure 7, starting from the lowest part of the robot, there is a chassis box where it consists of six batteries and four worm gear motors with two free-wheels in the middle. Going up one level, there is a middle box which acts as the 'brain' part of the robot. It consists of an Arduino Mega, two motor drivers MDD3A, and three ultrasonic sensors. Above the middle box, there placed a top box where it is stuffed with delivery items ordered by the user. There are also two sub-parts of the top box at the front and back of the robot. In the front, there placed a door lock mechanism system and a camera module for real-time monitoring. While, at the back side, there placed the GPS module, compass module and Wifi module ESP8266 for better access to the internet and satellite signal.

3.2 Mobile Application Sub-System

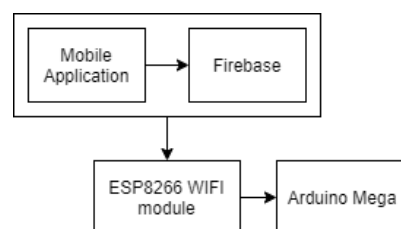

Figure 8. Block Diagram Architecture for system integration

The integration of the system is shown in Figure 8. Developed using Thinkable, the mobile application is in charge of obtaining the current location of the user in coordinate form. It is also used as an interface for delivery orders. The coordinate is then stored inside a Firebase real-time database which to be retrieved by the mobile robot for navigation purpose. Once the Arduino Mega receives the user's coordinate, it will start to navigate based on the fixed coordinates but in this work, there is only one set/path being experimented and the navigation does not function well.

3.3 Cloud Server Sub-System

Figure 9 shows the Firebase real-time database used as the intermediate between the mobile application and mobile robot. The user's coordinate is represented by the 'Lat' and 'Long' and the robot vehicle's coordinate is represented by the 'Delibot'. The robot vehicle's coordinate is updated in every 10s in the Firebase. The 'Door' gives the lock and unlock command to the robot vehicle in '1' and '0' value, which has been explained in previous section.

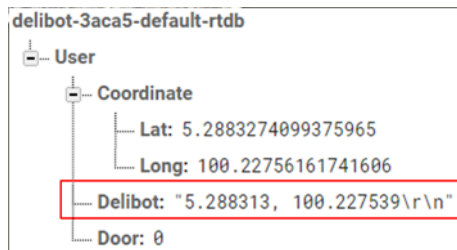

Figure 9. Robot's Localization Update

4. RESULT AND DISCUSSION

Each feature was coded, tested, and debugged until the functionality of each feature is satisfying, except for GPS navigation. During the code integration, any compiler error was debugged until the whole code is error-free and modifications are made to meet this project's requirements.

During the testing of mobile robot sub-system, some errors were detected due to some environmental factors especially related to GPS navigation. It cannot do GPS navigation properly and the movement is not so smooth. The obstacle avoidance feature works well with a bit awkward movement. The localization of the mobile robot is successfully updated in the cloud server for every 10s. As the robot started to move in 5s, the container was locked using a servo motor. A real-time monitoring of the navigation process can be viewed remotely as shown in Figure 5. The IP address for real-time monitoring varies with different internet connection.

For the mobile application sub-system, once the user permits to share his current location, the application saved his location into the Firebase as shown in Figure 10. The address shown is automatically retrieved from the OpenCage [20] website using the user's coordinate with reverse geocoding, to make sure the user confirms with his

selected location. The Open Cage is used to translate the user's coordinate into an address and the functionality is emerged with Thinkable.

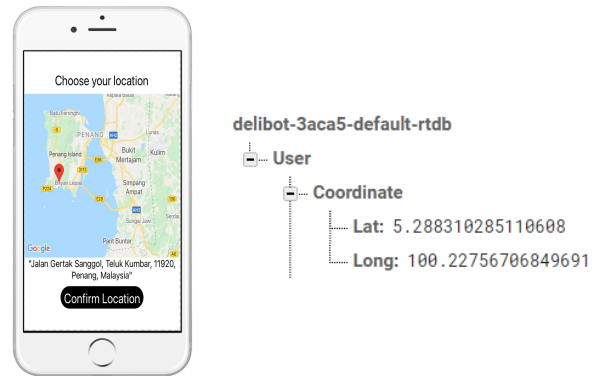

Figure 10. Current Location of the User

For the Firebase sub-system, it successfully collects the user's coordinate and the mobile robot's localization as shown in Figure 9.

At the end of the process, there is a button popped up inside the mobile application to be clicked by the user to unlock the container and retrieve all of his ordered things. Since the command from user is yet to complete, the door-lock mechanism is made to work in a timely manner. Since the robot vehicle is made from scratch, the design is not so good that the movement is unbalanced. As the result has been discussed, the performance is visualized in a Youtube Video with the link [21].

5. CONCLUSION

Delivery system is one of the essential things that is needed during this pandemic but to avoid any close contact between humans, a smart delivery robot ecosystem is one of the best initiatives to be developed. In this paper, we presented an early development stage of autonomous mobile robot for delivery project being done from scratch. For the mobile robot sub-system, the GPS navigation system has proved to be good for the initial objective as it provides localization information for the robot. However, in this work, GPS navigation could not function properly. The other features like obstacle avoidance, door lock, and real-time monitoring was a success and helps to provide completion to this project. This project also focuses on the safety of both the robot and the ordered items. The cloud server and mobile application sub-systems both achieved satisfying results. The integration of all sub-systems into one complete ADRS is yet to be done.

In the next step, the main thing to be done is the functionality of GPS navigation since it is the main function for the robot to be called as the Autonomous Delivery Robot System (ADRS). Then, the robustness of the system integration will be improved to ensure a better interaction between the robot, mobile application and the control system. The last important thing is to make sure that robot is always connected to the internet by using a more reliable internet source.

REFERENCES

- [1] M. Vasic and A. Billard. "Safety issues in human-robot interactions". In: 2013 IEEE International Conference on Robotics and Automation. 2013, pp. 197–204.
- [2] M. Edwards. "Robots in industry: An overview". In: *Applied Ergonomics* 15.1 (1984), pp. 45–53.
- [3] C. D. Kidd and C. Breazeal. "Robots at home: Understanding long-term human-robot interaction". In: 2008 IEEE/RSJ International Conference on Intelligent Robots and Systems. 2008, pp. 3230–3235.
- [4] Navid Panchi et al. "Deep Learning-Based Stair Segmentation and Behavioral Cloning for Autonomous Stair Climbing". In: *International Journal of Semantic Computing* 13.04 (2019), pp. 497–512.
- [5] U. Patil et al. "Deep Learning Based Stair Detection and Statistical Image Filtering for Autonomous Stair Climbing". In: 2019 Third IEEE International Conference on Robotic Computing (IRC). 2019, pp. 159–166.
- [6] Bhaskar, K., Mansoor, A., Anand, K. R., and Ramani, A. "Intelligent mail delivery robot," 2011 2nd International Conference on Intelligent Agent & Multi-Agent Systems.
- [7] Jeon, S., and Lee, J. "Vehicle routing problem with pickup and delivery of multiple robots for hospital logistics," 2016 16th International Conference on Control, Automation and Systems (ICCAS). IEEE, 2016, pp. 1572-1575.
- [8] Hirata, Y., Sugiyama, Y., and Kosuge, K. "Control architecture of delivery robot for supporting nursing staff," 2015 IEEE/SICE International Symposium on System Integration (SII). IEEE, 2015, pp. 345-351.
- [9] A. M. Rokonuzzaman, S. R. M.D and M. H. Mim, "Automated Restaurant Food Service Management system using a Line Follower Robot," in International Conference on Mechanical, Industrial and Energy Engineering, Bangladesh, 2014.
- [10] H. D. Chon, S. Jun, H. Jung and S. W. An, "Using RFID for Accurate Positioning," *Journal of Global Positioning Systems*, vol. III, no. 1-2, pp. 32-39, 2004.
- [11] Reyes, D., Millan, G., Osorio-Corparan, R., and Lefranc, G. "Mobile robot navigation assisted by GPS," *IEEE Latin America Transactions* Vol. 13, No. 6, 2015, pp. 1915-1920.
- [12] Zhang, Y., and Hong, D. P. "Navigation of mobile robot using Low-cost GPS," *International Journal of Precision Engineering and Manufacturing* Vol. 16, No. 4, 2015, pp. 847-850.
- [13] Cai, G.-S., Lin, H.-Y., and Kao, S.-F. "Mobile robot localization using gps, imu and visual odometry," 2019 International Automatic Control Conference (CACs). IEEE, 2019, pp. 1-6.
- [14] Bao, J., Yao, X., Tang, H., and Song, A. "Outdoor navigation of a mobile robot by following GPS waypoints and local pedestrian lane," 2018 IEEE 8th Annual International Conference on CYBER Technology in Automation, Control, and Intelligent Systems (CYBER). IEEE, 2018, pp. 198-203.
- [15] Ningombam, D., Singh, A., and Chanu, K. T. "Multipurpose GPS guided autonomous mobile robot," *Progress in Advanced Computing and Intelligent Engineering*. Springer, 2018, pp. 361-372.
- [16] Wang, Y., Goila, A., Shetty, R., Heydari, M., Desai, A., and Yang, H. "Obstacle avoidance strategy and implementation for unmanned ground vehicle using LIDAR," *SAE international journal of commercial vehicles* Vol. 10, No. 1, 2017, pp. 50-56.
- [17] Anh, P. Q., duc Chung, T., Tuan, T., and Khan, M. A. "Design and Development of an Obstacle Avoidance Mobile-controlled Robot," 2019 IEEE Student Conference on Research and Development (SCORED). IEEE, 2019, pp. 90-94.
- [18] Hutabarat, D., Rivai, M., Purwanto, D., and Hutomo, H. "Lidar-based obstacle avoidance for the autonomous mobile robot," 2019 12th International Conference on Information & Communication Technology and System (ICTS). IEEE, 2019, pp. 197-202.
- [19] Khairudin, M., Refalda, R., Yatmono, S., Pramono, H., Triatmaja, A., and Shah, A. "The mobile robot control in obstacle avoidance using fuzzy logic controller," *Indonesian Journal of Science and Technology* Vol. 5, No. 3, 2020, pp. 334-351.
- [20] <https://opencagedata.com/>
- [21] <https://youtu.be/e1hG6i-Awb>