

# Design and Fabrication of PVA-SnO<sub>2</sub>-Based Humidity Sensors

I Dewa Putu Hermida<sup>1,2\*</sup>, Asrul Izam Azmi<sup>1</sup>, Sevia Mahdaliza Idrus<sup>1</sup>, Goib Wiranto<sup>2</sup>, Robeth V. Manurung<sup>2</sup>, Nurul Hasanah<sup>2</sup>, Mustofa Amirullah<sup>2</sup>, Annida Rahmawati<sup>2</sup>, Syahrul<sup>2</sup>, Papat Hidayatullah<sup>2</sup>

<sup>1</sup>School of Electrical Engineering, Universiti Teknologi Malaysia, 81310 UTM Skudai, Johor, Malaysia.

<sup>2</sup>National Research and Innovation Agency, Gedung B.J. Habibie, Jl. M.H Thamrin No. 8, Jakarta Pusat-10340

\*Corresponding author: iputu@graduate.utm.my

**Abstract:** In this research, humidity sensors based on Polyvinyl Alcohol (PVA)-Tin Oxide (SnO<sub>2</sub>) have been designed and fabricated using screen printing. The sensor devices were fabricated on Alumina Substrate (Al<sub>2</sub>O<sub>3</sub>) with Silver (Ag) as the electrode material. The number of fingers on the electrodes was varied to obtain different sensor resistance values. SnO<sub>2</sub> was added to the PVA sensing layer with variations in the composition. The size of granules formed from mixing PVA-SnO<sub>2</sub> material will also be observed.

**Keywords:** Relative humidity sensor; thick film technology; screen printing; PVA; SnO<sub>2</sub>.

© 2023 Penerbit UTM Press. All rights reserved

Article History: received 27 September 2022; accepted 9 April 2023; published 28 April 2023.

## 1. INTRODUCTION

There are several applications where humidity measurement is crucial, including instrumentation, medicine, automation, agriculture, climatology, and geographic information systems. Humidity is defined as the amount of water vapor in the air. The importance of humidity to human life is manifested in various fields, such as atmospheric science [1], chemistry, medicine [2], and agriculture [3]. The relative humidity (RH) unit is the ratio of the actual amount of moisture in the atmosphere to the amount of humidity it can hold at the same temperature and pressure. Unlike absolute humidity (AH), relative humidity depends on temperature and pressure [4-6].

$$RH(\%) = \frac{P_v}{P_s} \times 100$$

where:

*RH*: Relative humidity (%)

*P<sub>v</sub>*: Actual water vapor pressure (bar or KPa)

*P<sub>s</sub>*: Saturated water vapor pressure (bar or KPa)

In the development of humidity sensors, slow response times and low sensitivity are the main problems. Most of humidity sensors work on the principle of changes in the electrical characteristics of a sensing layer due to the absorption of moisture [7]. In measuring humidity parameters, the sensing layer can be developed as a resistive [8] or capacitive [9] structure. Optical technology-based humidity sensors are becoming popular [10] because of their advantages, unlike electricity-based humidity sensors, which are expensive to produce.

Thick film technology is one of the established process technologies in which the sensor structure, including the sensitive layer, is printed onto a ceramic substrate [11]. Screen printing is done by squeezing the paste material through a net in a predetermined pattern. Various materials

can be screen printed for sensor applications, including polymers, metals, and semiconductors. This technique generates micrometer-sized paths, which are suitable for device miniaturization [12]. Screen printing techniques also allow the mass production of devices and manufacturing processes that can be customized for the desired application [13].

The sensing materials applied in humidity sensors range from metal oxide semiconductors [14], polymers [15], graphene [16], and other composite materials. In terms of cost-effectiveness and ease of fabrication, previous studies have shown that semiconductor metal oxides such as Titanium Dioxide (TiO<sub>2</sub>), Zinc Oxide (ZnO), Zirconium Oxide (ZrO<sub>2</sub>), and Tin Oxide (SnO<sub>2</sub>) have good characteristics as sensing layers in sensors moisture [17-19]. Of particular interest is SnO<sub>2</sub>, which is known to be versatile and has been used in many sensor applications, including humidity-sensing materials [20]. Besides metal oxides, polymers have also been commonly used in humidity sensing, such as polyimide [21], polymethyl methacrylate (PMMA) [22], and polyvinyl alcohol (PVA) [23]. This polymer material can be found easily in nature. Due to their hydrophilic structure, they can absorb moisture and, thus, have great potential for use as moisture-sensing materials. The presence of hydroxyl groups (OH) in polymers such as PVA makes their conductivity change when exposed to variations in humidity in the air [24]. The nominal resistance of PVA is also relatively high, so other ingredients, such as metal oxides, are often added to reduce it.

Adding metal oxides, such as SnO<sub>2</sub>, to PVA will not affect the polymer structure, as shown in previous studies [5]. The presence of metal oxides in the mix with PVA can affect sensor characteristics in two ways; a decrease in resistance value and an increase in response time when

applied as a moisture-sensing layer. In general, the higher the concentration of  $\text{SnO}_2$ , the lower the resistance value of the sensor and the faster the response time to changes in humidity. This research involved designing, fabricating, and characterizing a thick film moisture sensor based on PVA- $\text{SnO}_2$ . The functionality and performance of the thick film humidity sensor were tested against variations in humidity and temperature. The design, fabrication, and characterization of a thick film moisture sensor based on PVA- $\text{SnO}_2$  will be described in this paper.

## 2. SENSOR DESIGN

The humidity sensor is designed to have four layers, an alumina substrate, an electrode layer, a sensing layer, and a dielectric layer. The construction of the humidity sensor is shown in Figure 1. The substrate used is Alumina Substrate ( $\text{Al}_2\text{O}_3$ ); the electrode layer is located on the substrate in the form of a Finger/Interdigitated Electrode (IDE), then the sensing layer uses a mixture of PVA- $\text{SnO}_2$  solution, which covers the entire finger electrode/finger.

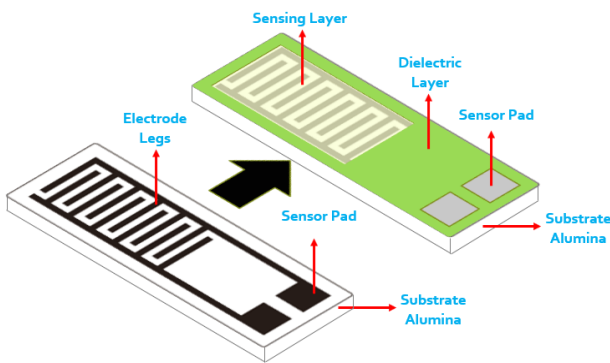

Figure 1. Design of sensor layers

The sensing layer interacts with the water vapor deposited between the two electrodes. Then after that, the resistance value that is read on the two electrodes will change due to the influence of the amount of water molecule content. The sensor resistance value will decrease as the humidity level of the air around the sensor increases. The adsorption of water vapor will increase the conductivity of the sensor due to its excellent electrical conductivity. The type of resistive sensor is based on the following equation:

$$R = \rho \frac{l}{A}$$

Where:

$R$ : Material resistance ( $\Omega$ )

$\rho$ : Material resistance ( $\Omega.cm$ )

$l$ : Length (cm)

$A$ : Cross-sectional area ( $cm^2$ )

In this study, three different configurations of finger electrodes were designed. All three sensor types are printed on one substrate to maximize the use of an alumina substrate measuring  $50 \times 50$  mm, as shown in Figure 2(a). The layout aims to produce an optimal geometry following the capabilities of thick film technology and prevent failures during the sensor fabrication process. A tolerance distance of 2 mm is provided between the electrode and the edge of the substrate. The distance between the toes is designed at 0.5 mm. The distance between electrode types

is 4 mm to minimize errors in manual cutting between sensors. The electrode design results are printed using a 325 mesh with a  $45^\circ$  slope for screen printing. The humidity sensor dimensions are illustrated in Figure 2(b).

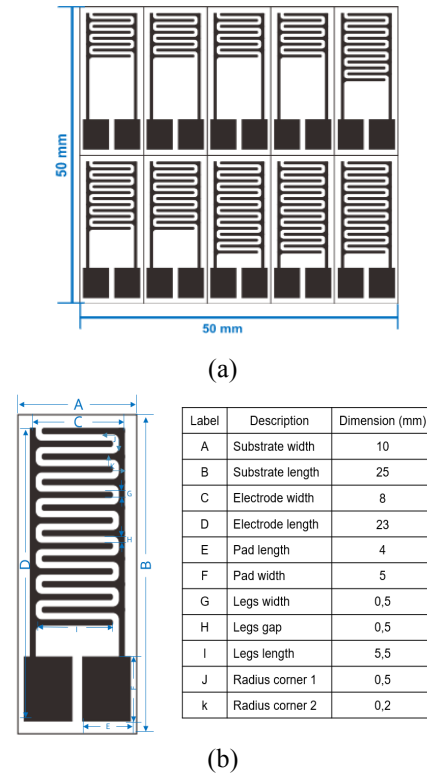

Figure 2. Sensor design: (a) electrode design (b) electrode dimensions

The mechanism for measuring humidity sensors is that while measuring humidity, the sensor device being tested will be subjected to moisture in a chamber. Therefore, conditions need to be conditioned so that the interaction of the sensor device with water vapor only occurs in the PVA-based sensing layer. For this reason, a dielectric passivation layer has been applied in the sensor structure, covering all areas except the sensitive sensing and pad areas. The mask for the dielectric passivation layer is illustrated in Figure 3.

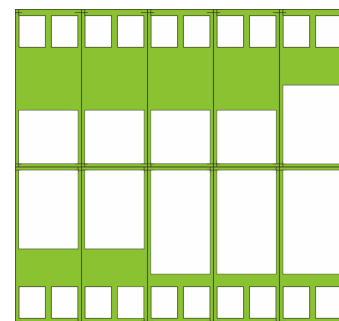

Figure 3. Design of passivation layer

## 3. DEVICE FABRICATION

The fabrication process for making a humidity sensor will be explained in the flowchart of Figure 4. Fabrication of a polymer layer is a process for preparing a sensing material.

In this study, a humidity sensor was made with two types of sensing layer material variations. The first sensing layer was prepared with PVA-SnO<sub>2</sub> with a ratio of 1:1 and 1:2. The composition of [5] is summarized in Table 1. The difference in paper [5-6] lies in the finger material using pure Ag (silver) metal, and this is intended to determine changes in resistance and sensitivity as well as the response time of the realized humidity sensor.

Table 1. Polymer composition

No	DI Water (mL)	PVA (mg)	SnO <sub>2</sub> (mg)	APS (mg)
1.	10	1000	1000	40
2.	10	1000	2000	40

The process of making the sensing layer by mixing it and then stirring it with DI water using a magnetic stirrer for 6 hours at 90°C until it is homogeneous. After that, the mixture was left to cool. Then ammonium peroxy disulfate (APS) was added, followed by stirring for 30 minutes using a magnetic stirrer. The polymer solution is allowed for one day before being coated on the substrate.

The fabrication begins with making an electrode pattern on an alumina substrate using silver paste (Ag) with a screen-printing process. Then the substrate is heated using a Conveyor Belt Furnace RTC LA-310 in Zone 1. Pre-Heating 500°C for 10 minutes, Zone 2. Firing 750°C for 15 minutes, and Zone 3. Cooling at 500°C for 10 minutes. After that, the dielectric layer (coating) screen printing process is carried out using a dielectric composition paste and followed by the heating process at 110°C for 10 minutes.

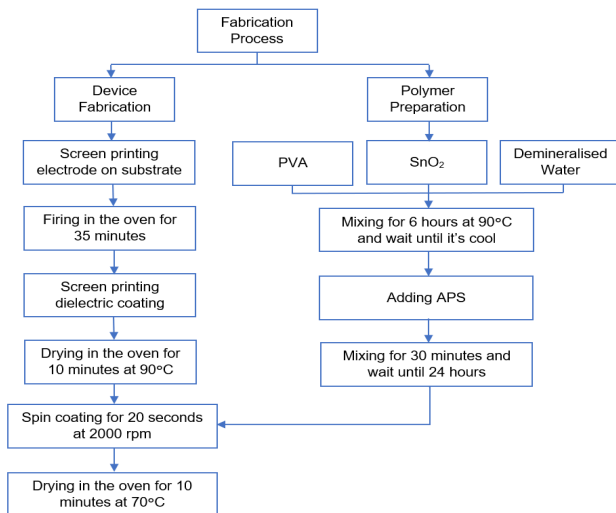

Figure 4. Flowchart of a fabrication process

The final process stage is coating the finger electrode (sensing layer) with the PVA-SnO<sub>2</sub> mixture through a spin coating process for 20 seconds at a speed of 2000 rpm. It was followed by heating the sensing layer structure at a temperature of 60°C for 7-8 minutes. The fabrication produces six sensor variations, as shown in Table 2.

Table 2. Sensor configurations

Device Name	Finger Pair	Polymer Ratio (PVA:SnO <sub>2</sub> )
A	4	1:1
B	6	
C	8	
D	4	1:2
E	6	
F	8	

#### 4. CHARACTERIZATION SETUP

Figure 5 shows a schematic diagram of the test used in this study to determine the electrical characteristics of the sensor. The humidity sensor is placed in the chamber, and the humidity in the sensor chamber is varied from 50-90% RH by exposing/spouting water vapor from the humidifier. The results of the sensor testing process obtained the resistance value of the humidity sensor. The block diagram in Figure 5(a) depicts three sensors placed in the chamber, including a temperature sensor, a reference humidity sensor, and a humidity sensor under test (Device Under Test) as inputs. The HMP60 K-type probe and the Thermocouple provide reference measurements of temperature and humidity, respectively. The two probes are connected to the chamber controller for humidity and temperature conditioning. Room temperature is regulated by heating and Peltier, while the humidifier controls humidity. Testing the humidity sensor uses a Keithley 6517b High Resistance Meter to measure changes in resistance values.

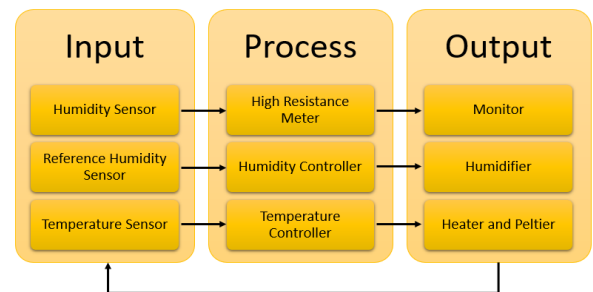

(a)

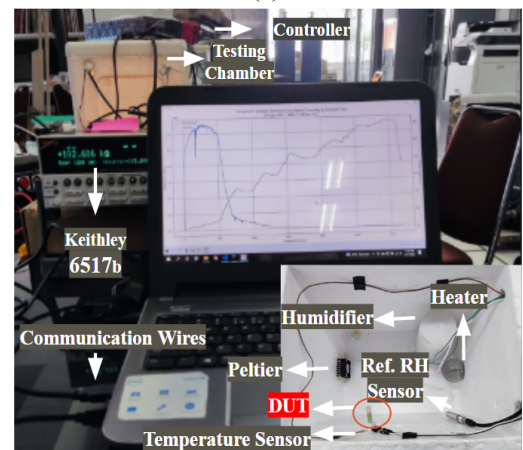

(b)

Figure 5. Characterization setup: (a) block diagram of testing; (b) measurement process and (lower right) set up inside the chamber

The Keithley measuring instrument is connected to the PC via the GPIB (General Purpose Interface Bus) as an interface to obtain data and read the results of measurements of resistance and temperature values, as shown in Figure 6. The temperature and humidity sensors in the chamber are connected to Keithley, and GPIB sends timer, humidity, temperature, and resistance data to be read by the PC. The PC is used for monitoring during testing as well as the interface during testing. Measurement results are displayed in a visualization in the form of graphs and data structures in .csv format.

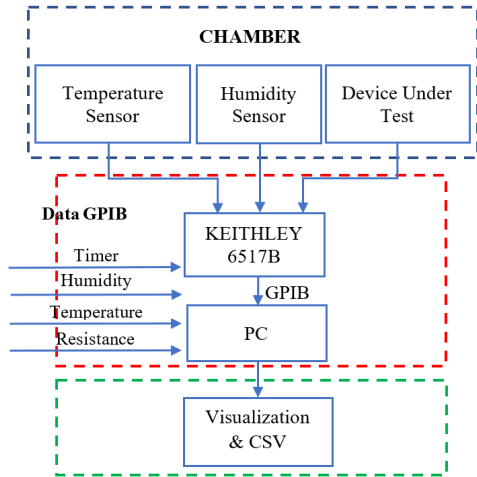

Figure 6. Block diagram of a data acquisition system for the humidity sensor characterization

5. RESULT

Figure 7 shows the results of the comparison of PVA-SnO<sub>2</sub> compositions analysed using SEM. The variation in grain size resulting from the mixing process between the PVA-SnO<sub>2</sub> materials looks irregular/not ideal, which reduces the sensitivity and response time of the humidity sensor. From these results, it is necessary to improve the fabrication formula to increase the homogeneity of the PVA-SnO<sub>2</sub> composition. The granules formed from mixing the PVA-SnO<sub>2</sub> material are between 782.68 nm - 1103 μm, as shown in Figure 8.

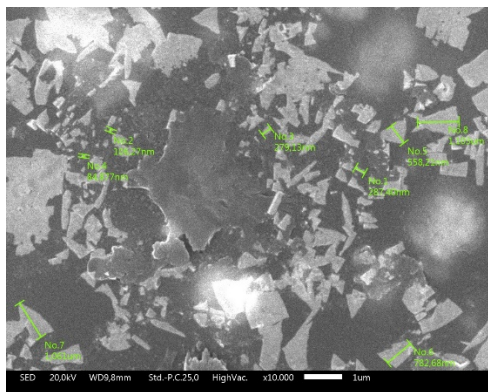

Figure 7. SEM 1000x PVA-SnO<sub>2</sub>

Variations in the number of fingers/electrodes on the humidity sensor will only affect the resistance value, not linearity. The number of fingers/electrodes that are more/larger has a smaller resistance value than the number of fingers that are smaller/less because the more the number of fingers/electrodes, the humidity sensor will

have a more comprehensive coverage area of the sensing layer.

From the results of ratio test PVA:SnO<sub>2</sub> = 1:1, the optimal electrode configuration design is eight fingers because it is linear and has a lower resistance (the more fingers, the lower the resistance value). For the ratio of PVA:SnO<sub>2</sub> = 1:2, the most optimal is finger six because too much SnO<sub>2</sub> composition causes the sensor to reach saturation faster, so it looks non-linear.

The results of measuring the resistance and humidity of each sensor are shown in Figure 9.

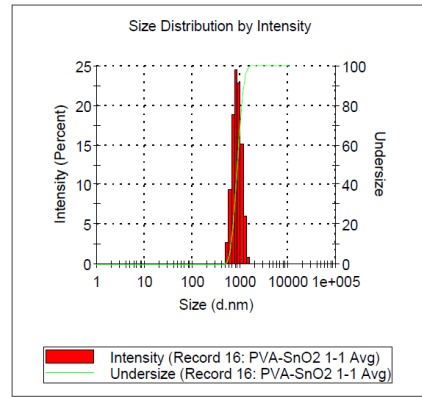
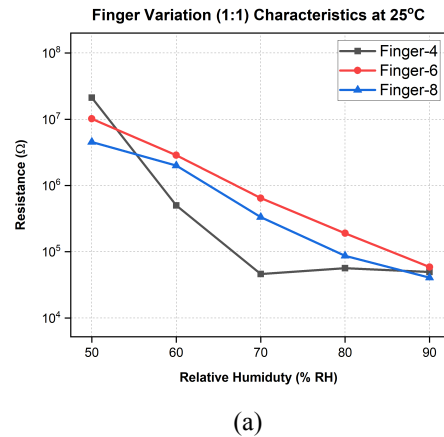
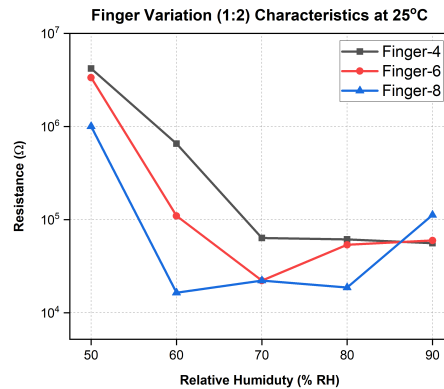

Figure 8. Particle test results using PSA



(a)



(b)

Figure 9. The relationship between humidity and resistance. (a) 1:1, (b) 1:2

6. CONCLUSIONS

Increasing the number of fingers on the electrodes can increase the sensitivity of the humidity sensor, as more surface area is exposed to the sensing material. This can

lead to more accurate and precise measurements of humidity levels.

Humidity sensors using thick film technology based on Polyvinyl Alcohol (PVA) and Tin Oxide (SnO<sub>2</sub>) polymer materials have been successfully designed, realized, and characterized. The humidity sensor uses a screen-printing technique on an Alumina Substrate (Al<sub>2</sub>O<sub>3</sub>) with Silver (Ag) electrode material. SnO<sub>2</sub> material was added to the PVA sensing layer with various compositions of 1:1 and 1:2. Analysis of the PVA-SnO<sub>2</sub> design indicated that a fabrication process was required to ensure better homogeneity of the sensing layer; thus, the sensing performance can be improved as well.

#### ACKNOWLEDGMENT

We acknowledge the financial support from the National Research and Innovation Agency (BRIN) 2022 and Universiti Teknologi Malaysia (UTM) Research Contract Grant (R.J130000.7351.4B734).

#### REFERENCES

- [1] Environmental weather monitoring and farm information tracking system." *J. Crit. Rev.*, vol. 7, no. 7, pp. 307–310, 2020, doi: 10.31838/jcr.07.07.49
- [2] G. Wang et al., "Fast-response humidity sensor based on laser printing for respiration monitoring," *RSC Adv.*, vol. 10, no. 15, pp. 8910–8916, 2020, doi: 10.1039/c9ra10409g
- [3] J. Rodríguez-Robles, Á. Martín, S. Martín, J. A. Ruipérez-Valiente, and M. Castro, "Autonomous sensor network for rural agriculture environments, low cost, and energy self-charge," *Sustain.*, vol. 12, no. 15, 2020, doi: 10.3390/SU12155913.
- [4] H. Farahani, R. Wagiran, and M. N. Hamidon, "Humidity sensors principle, mechanism, and fabrication technologies: A comprehensive review," *Sensors*, vol. 14, no. 5, pp. 7881 – 7939, 2014, doi: 10.3390/s140507881.
- [5] G. Wiranto, S. Martadi, M. A. Sulthoni, I D. P. Hermida, Y. Y. Maulana, S. Widodo, D. P. Kurniadi, P. Daud, The Effect of SnO<sub>2</sub> Mixture on a PVA-Based Thick Film Relative Humidity Sensor, 2022, *International Journal on Advanced Science Engineering Information Technology (IJASEIT)*, Vol.12 No.3, ISSN: 2088-5334, pp.1060 - 1065
- [6] S. Martadi, M. A. Sulthoni, G. Wiranto, A. Surawijaya, I D. P. Hermida, "Design and Fabrication of PVA-Based Relative Humidity Sensors Using Thick Film Technology", 2019, *Proc. International Symposium on Electronics and Smart Devices*, pp.
- [7] T. Nitta, and S. Hayakawa, *Ceramic Humidity Sensors*, *IEEE Transactions on Components, Hybrids, and Manufacturing Technology* Vol. 3, 1980.
- [8] D.Z. Zhang, Z.Y. Xu, Z.M. Yang, X.S. Song, High-performance flexible self-powered tin disulfide nanoflowers/reduced graphene oxide nanohybrid-based humidity sensor driven by triboelectric nanogenerator, *Nano Energy* 67 (2020), 104251
- [9] D.Z. Zhang, X.Q. Zong, Z.L. Wu, Y. Zhang, Hierarchical self-assembled SnS<sub>2</sub> nanoflower/Zn<sub>2</sub>SnO<sub>4</sub> hollow sphere nanohybrid for humidity-sensing applications, *ACS Appl. Mater. Interfaces* 38 (2018) 32631–32639
- [10] J. Ascorbe, J.M. Corres, I.R. Matias, F.J. Arregui, High sensitivity humidity sensor based on cladding-etched optical fiber and lossy mode resonances, *Sensors Actuators B Chem.* 233 (2016) 7–16.
- [11] M. Awais, M. U. Khan, A. Hassan, J. Bae, and T. E. Chattha, "Printable highly stable and superfast humidity sensor based on two dimensional molybdenum diselenide," *Sci. Rep.*, vol. 10, no. 1, pp. 1–13, 2020, doi: 10.1038/s41598-020-62397-x
- [12] V. S. Turkani et al., "A highly sensitive printed humidity sensor based on a functionalized MWCNT/HEC composite for flexible electronics application," *Nanoscale Adv.*, vol. 1, no. 6, pp. 2311–2322, 2019, doi: 10.1039/c9na00179d
- [13] D. Antuña-Jiménez, M. B. González-García, D. Hernández-Santos, and P. Fanjul-Bolado, "Screen-printed electrodes modified with metal nanoparticles for small molecule sensing," *Biosensors*, vol. 10, no. 2, pp. 1–22, 2020, doi: 10.3390/bios10020009
- [14] M. Velumani, S.R. Meher, Z.C. Alex, Impedometric humidity sensing characteristics of SnO<sub>2</sub> thin films and SnO<sub>2</sub>-ZnO composite thin films grown by magnetron sputtering, *J. Mater. Sci. Mater. Electron.* 29 (2018) 3999–4010, <https://doi.org/10.1007/s10854-017-8342-z>
- [15] J. Dai, H. Zhao, X. Lin, S. Liu, Y. Liu, X. Liu, T. Fei, T. Zhang, Ultrafast response polyelectrolyte humidity sensor for respiration monitoring, *ACS Appl. Mater. Interfaces* (2019), <https://doi.org/10.1021/acsami.8b18904>
- [16] A.D. Smith, K. Elgammal, F. Niklaus, A. Delin, A.C. Fischer, S. Vaziri, F. Forsberg, M. Råsander, H. Hugosson, L. Bergqvist, S. Schröder, S. Kataria, M. Östling, M.C. Lemme, Resistive graphene humidity sensors with rapid and direct electrical readout, *Nanoscale* 7 (2015) 19099–19109, <https://doi.org/10.1039/c5nr06038a>.
- [17] S. Patil, N. Ramgir, S. Mukherji, V.R. Rao, PVA modified ZnO nanowire based microsensors platform for relative humidity and soil moisture measurement, *Sens. Actuators B Chem.* 253 (2017) 1071–1078, <https://doi.org/10.1016/j.snb.2017.07.053>
- [18] Y. Lu, Z. Wang, S. Yuan, L. Shi, Y. Zhao, W. Deng, Microwave-hydrothermal synthesis and humidity sensing behavior of ZrO<sub>2</sub> nanorods, *RSC Adv.* 3 (2013) pp.11707–11714, <https://doi.org/10.1039/c3ra40670a>.
- [19] P.M. Faia, E.L. Jesus, C.S. Louro, TiO<sub>2</sub>:WO<sub>3</sub> composite humidity sensors doped with ZnO and CuO investigated by impedance spectroscopy, *Sens. Actuators B Chem.* 203 (2014) pp. 340–348, <https://doi.org/10.1016/j.snb.2014.06.117>.
- [20] M. Velumani, et al. Composite metal oxide thin film based impedometric humidity sensors, *Sensors & Actuators: B. Chemical* 301 (2019), pp. 1-10, <https://doi.org/10.1016/j.snb.2019.127084>
- [21] H. Liu et al., "Humidity sensors with shielding electrode under interdigitated electrode," *Sensors*, vol. 19, no. 3, 2019, doi: 10.3390/s19030659.
- [22] Z. Harith, H. Adnan Abdullah Zain, M. Batumalay, and S. Wadi Harun, "A research on relative humidity sensors using PVA and PMMA coating," *J. Phys. Conf. Ser.*, vol. 1371, no. 1, 2019, doi: 10.1088/1742-6596/1371/1/012027.
- [23] S. Automation, G. R. Biswal, S. Member, P. Mohanty, and K. J. Akram, "Design and fabrication of an inexpensive capacitive humidity sensor for smart substation automation," *IEEE Sens. J.*, vol. 20, no. 12, pp. 6215–6223, 2020.
- [24] S. Erizon., Studi komposit PVA-PEO-TiO<sub>2</sub> sebagai material sensitive terhadap kelembaban, Tesis Program Pascasarjana Fisika, Universitas Indonesia, 2008.