



UTM
UNIVERSITI TEKNOLOGI MALAYSIA

**INTERNATIONAL JOURNAL OF
INNOVATIVE COMPUTING**

ISSN 2180-4370

Journal Homepage : <https://ijic.utm.my/>

Automatic Control and Monitoring Air Conditioner Temperature (Using Arduino)

Idzni Mohamed Rashid¹ & Hazinah Kutty Mammi²

Dept. of Computer Science

Faculty of Computing

Universiti Teknologi Malaysia

81310 UTM Johor Bahru, Johor, Malaysia

Email: idzni@graduate.utm.my¹; hazinah@utm.my²

Submitted: 23/2/2023. Revised edition: 10/9/2023. Accepted: 17/9/2023. Published online: 24/11/2023

DOI: <https://doi.org/10.11113/ijic.v13n2.399>

Abstract—Servers are essential in this current digital world as the mainstay communication between human and the desired services and information. Its existence and usage of course highlight the requirement to secure it both physically and also through the digital space. This is of course a well known and accepted. Another essential needed in ensuring that services are not interrupted is through the well-being of the servers themselves. Due to the amount of processing a server does, it tends produce heat, which have to be managed to prevent overheating, and thus ensuring that it can continue to its job. The server room also needs full maintenance supervision, as every component and tool supplied must be in good condition. The temperature and humidity of the server room must be in a stable state to prevent electronic components from getting wet and causing rust. Therefore, this project will discuss and develop a device that can prevent such issues. The developed device can read the room temperature and humidity accurately and control the air conditioner's temperature for temperature stability to be in the proper condition. This device is also capable of sending and reading data to a database. As a result, users can monitor the server room temperature from different places. This project can help reduce the workload of employees without any time wasted continuously and manually checking the conditions.

Keywords—IoT, Temperature and Humidity, Web

I. INTRODUCTION

A server room is primarily a zone where a vast amount of computer hardware is stored. These interconnected machines build a cloud network that offers storage and running rates far surpassing a single machine's capacity. The servers may administer massive databases or host multiple large users of computer software programs. The most frequent use of a server room is to store equipment with information accessible on the

Internet. Reportedly, each 10 °C temperature rise would reduce the server component life by 50% [1x]. Temperature is an important factor that can influence the performance and reliability of servers in their element.

Data centre managers faces five common server room problems every day, such as temperature, humidity, vibration, water, and poor cable management. These threats have the potential to harm equipment, compel it to shut down and degrade performance [2]. Not identifying all hazards is a problem that many organizations have when it comes to server room management. It is vital to detect, monitor, and report any danger that may exist in facilities.

A similar problem, albeit in a smaller scale, can be seen in various companies and institutions that have server rooms but still employ the same old method of manually adjusting the air conditioner through the remote control by pressing the button and not recording all the data of the server room temperature and humidity. The risk will occur when the room is too cold or too hot if not monitored carefully. [3xx] outlined the potential risks to include the following:

- Too high or too low temperature can damage hardware, which alternately can also waste electricity.
- too low humidity can trigger static electricity around the server room.

In this study, we have worked together with a local company, and proposed a solution for them in a form of a device that can control and monitor the temperature and humidity of the server room. This company is not a large company, hence do not have the resources readily available to bigger companies and data centres. The Internet of Things (IoT) will be the basis for the

development of the Automatic Control and Monitoring Air Conditioner Temperature (AC-MAC). AC-MAC provides a way to detect the temperature and humidity of the server room. It can automatically control the air conditioner’s temperature without any human interaction, and all the reading temperatures and humidity will be displayed and recorded on the web portal for future reference.

II. LITERATURE REVIEW

Apart from reviewing the hardware and software to be used, this project also looked into reviewing the applications in existing systems to help identify best practice; as well as important features and characteristics. The three IoT devices chosen for the system analysis are:

- Cielo Breez Plus.
- Ecobee3 Lite Smart Thermostat.
- Xiaomi Aqara Socket Air Conditioning Companion.

1. Cielo Breez Plus

Cielo Breez Plus is an intelligent thermostat that controls air conditioners from various places. The system contains a comprehensive set of local controls that enable the user to use the air conditioner (AC) without Wi-Fi. This device has temperature sensing that makes it easier for the user to get the temperature they want. It also reduces electricity by keeping energy consumption minimal. The screen on the Breez Plus is simple to understand, dimmable, and records both the indoor temperature and relative humidity. The Cielo Breez Plus is a plug-and-play Wi-Fi-enabled smart air conditioner controller that works with all kinds of air conditioning systems that use a remote control (Novak, 2020) [4].

2. Ecobee3 Lite Smart Thermostat

The Ecobee3 Lite Smart Thermostat is intended to save money and give greater control. It was designed with the most important features in mind, which may save up to 23% on yearly energy bills. It also allows users to operate their devices from any location using the iOS or Android operating systems. Additionally, the Ecobee thermostat is compatible with Apple HomeKit on all iOS devices, including the Apple Watch, and leading creative home ecosystems, such as Google Assistant. The Ecobee Smart Sensor, which can detect and regulate temperature automatically, was offered for balancing the room temperature.

3. Xiaomi Aqara Socket Air Conditioning Companion

Xiaomi Aqara Air Conditioning Companion Smart Home Socket is an intelligent product that uses infrared to operate the air conditioner through Wi-Fi and ZigBee wireless network technologies and serves as the control centre for ZigBee devices in the smart home. Combining ZigBee sensors and controllers

enables energy conservation, power savings, pleasant sleep, local control, and other high-end features.

In terms of the platform, Xiaomi Aqara Air Conditioning Companion Socket and Cielo Breez Plus are fully integrated into a mobile application for registration for the first time. In contrast, the Ecobee3 Lite Smart Thermostat is a hybrid of iOS, Android, and the web for registration. In controlling the AC, all these three existing products can be controlled by using a mobile application.

The difference between all these three products is that the way the reading temperature and humidity is displayed. The Cielo Breez Plus and Ecobee3 Lite Smart Thermostat both have a built-in touch screen. Meanwhile, the Xiaomi Aqara Air Conditioning Companion Socket has no built-in screen.

The apparent similarity between these three products is that they can perform similar tasks, such as displaying data on a mobile application, detecting the temperature and humidity of the environment, and controlling the air conditioner’s temperature. Further comparison can be seen in Table 1 below.

TABLE 1. Comparison between Cielo Breez Plus, Ecobee3 Lite Smart Thermostat, and Xiaomi Aqara Air Conditioning Companion Socket

Characteristics	Cielo Breez Plus	Ecobee3 Lite Smart Thermostat	Xiaomi Aqara Air Conditioning Companion Socket
Target user	Public	Public	Public
Free?	No	No	No
Security	Basic	Basic	Basic
Database recorded?	No	No	Yes
Wi-Fi connection	Yes	Yes	Yes
Technology used	IoT Mobile-App	IoT Mobile-App Web-app	iOS Mobile-App
Platform	iOS Android OS	iOS Android OS Web Portal	iOS Android OS
Display	Built-in touch screen Mobile-app	Built-in touch screen Mobile-app	Mobile-App

III. METHODOLOGY

Agile development is based on the fact that changes are delivered incrementally, allowing for the discovery of certain benefits as the product develops at an early stage. The product is tested after each cycle. The Agile methodology enables teams to detect and fix minor issues in the project before they escalate into another stage of the project. The popularity of agile methodologies is based on the characteristics of requirements, the size of the organization, and the experience of the project team. There are numerous studies and surveys that have been conducted [5], and Agile methodology has proven its efficiency and ability to reshape the industry.

Agile development has a unique design, such as accepting modifications throughout each transition stage. It is easier for the project team to identify and detect problems that occur in the early phases. Agile design enables any necessary choices to be taken quickly, while there is still time to make a major difference

to the outcomes. Therefore, the detection of problems at an early stage can prevent the developed system from becoming defective after being launched to the public.

Agile solo scrum architecture primary goals are to maintain and ensure the complicated system to be more productive and have a fast delivery rate. Scrum is challenging to perform by one developer since the designed structure is for team-based work. Furthermore, a single developer can still make minimal changes since the primary components of the project plan and sprint phase can be completed. There have been situations where individuals attempted to run their project as a solo scrum in almost any event. It is because the scrum framework enables developers to manage and coordinate their product development more effectively. For instance, scrum utilizes user stories to build a project schedule that assists in leading the user needs [6].

A developer is able to lead the requirements listed for the sprint from the project schedule, and each sprint that has been completed is an executable function of features from the product development. At the same time, by performing the sprint tasks from the developers, they were able to obtain any input and acceptance from stakeholders. Therefore, the developer helps in identifying their work with clients, ensuring the output is delivered on time, and notifying the developer of any required errors. Additionally, Scrum has four fundamental components that would also allow it to be done by a single developer. The Agile solo scrum is very useful in developing the AC-MAC as all the essential functions are flexible and adaptable.

The minimum hardware requirements for this project are stated as follows:

1. Computer
 - Windows 7 32-bit.
 - 3GB of RAM.
2. Smartphone
 - Able to connect internet.
 - 2GB of RAM.
3. IoT
 - Arduino Mega 2560.
 - ESP8266.
 - TSOP1738.
 - DHT11.
 - Breadboard.
 - OLED LCD.
 - IR LED Transmitter.
 - BLDC Fan.

The minimum software requirements for this project are stated as follows:

1. Atom IDE v1.54
2. Arduino IDE v1.8.15

TABLE 2. The Technology used and description

Technology	Description
Arduino MEGA 2650	Function as central control that can process all the input data environment based on the coding process. As a result, the output will be executed for taking the appropriate actions.

Technology	Description
Data Transfer ESP8266	Responsible for establishing connection with Wi-Fi and making sure all the reading data able to store inside the database
TSOP1738 Component	Responsible for reading and copying all the signal sent by the AC's remote control. This component will be corresponding with the Arduino.
DHT11 Component	Responsible for detecting the temperature and humidity of the surrounding environment and transfer the input to Arduino.
OLED Display Component	Responsible for displaying all the reading data such as humidity and temperature and very high durability.
IR LED	Responsible for sending an infrared signal to AC. Each signal that has been generated from AC's remote control will be read, copied will be sending signal whenever the operation requires it.
Arduino IDE	Responsible for building the programming code to be deployed to Arduino for instructing the input to make an appropriate output.
Atom IDE	Responsible for making the web development and display all the reading data purposely for monitoring through the internet.
Firebase	Database platform that responsible for storing the reading data temperature and humidity that have been sent from the IoT device purposely for monitoring through the website. The reporting data is viewable for reporting. The account will be owned by the organization.

IV. SYSTEM DESIGN AND DEVELOPMENT

Two main users of the system are the manager and the staff. Managers and staff are able to view current and past temperature and humidity information; get notification when the temperature or humidity get to abnormal levels and get a report of the information collected. Table 3 shows these functions with description. From the use case, a sequence diagram is constructed to illustrate the activities, processes, and tasks associated with each user who interacts with the system. The sequence diagrams are used to demonstrate the capabilities of the system for each user. The following section will display the sequences for each planned use case, including the management and staff. Fig. 1 indicates how the system displays the temperature and humidity interface. The user will select the temperature and humidity interface. After that, the user will select the specific date and the list by date object control will get the information from the database. The database will return the desirable information back to the object control. The object control will display the information to the user.

TABLE 3: User's Use Case and the description

Use Case	Description
View display Temperature and Humidity information	View the overall data such as the temperature and humidity, time, and date directly from database table into the web portal.
Get Notification	Notification will pop up in the web portal alerting the user for letting them know if the reading temperature or humidity is in unnormal.
View Information Report	The user able to view the information report such as the graph, monthly and weekly report in the web portal

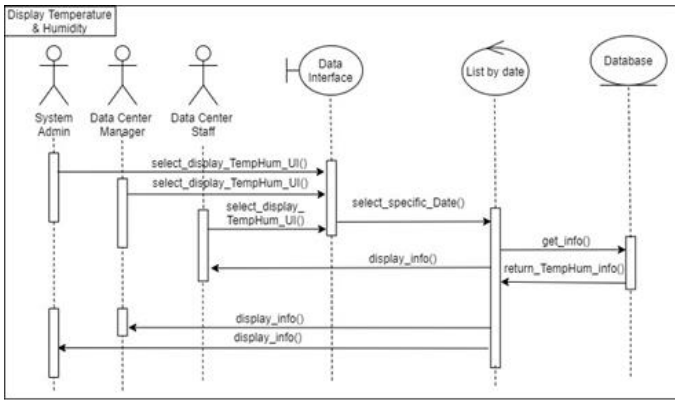

Fig 1. Sequence diagram of view temperature and humidity

The primary purpose of the activity diagram is to show the flow of activities by the user towards the system in doing their tasks. Fig. 2 exhibits the *view display temperature and humidity* activity diagram. With access to the system, when the user will click the view temperature and humidity button. The system will display all the information and users have the authority to select a specific date. The system will check if the date is valid and true. It will return the desired data according to the selection. If the date is false, the system will ensure that users need to select a valid date.

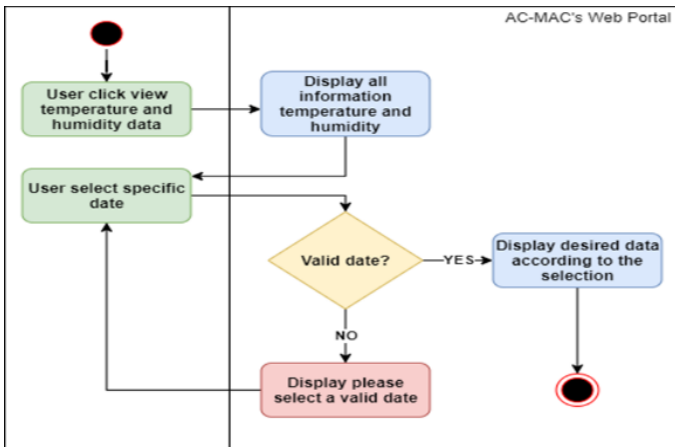

Fig 2. Activity diagram of view temperature and humidity

Fig. 3 shows the Activity diagram of *Get Notification Alert Module*. The DHT11 sensors scan the room and the information is sent to the database. Any temperature or humidity values that are out of the normal values will trigger a notification to the manager. The manager will assign the staff to do a maintenance check and take appropriate actions towards recovery.

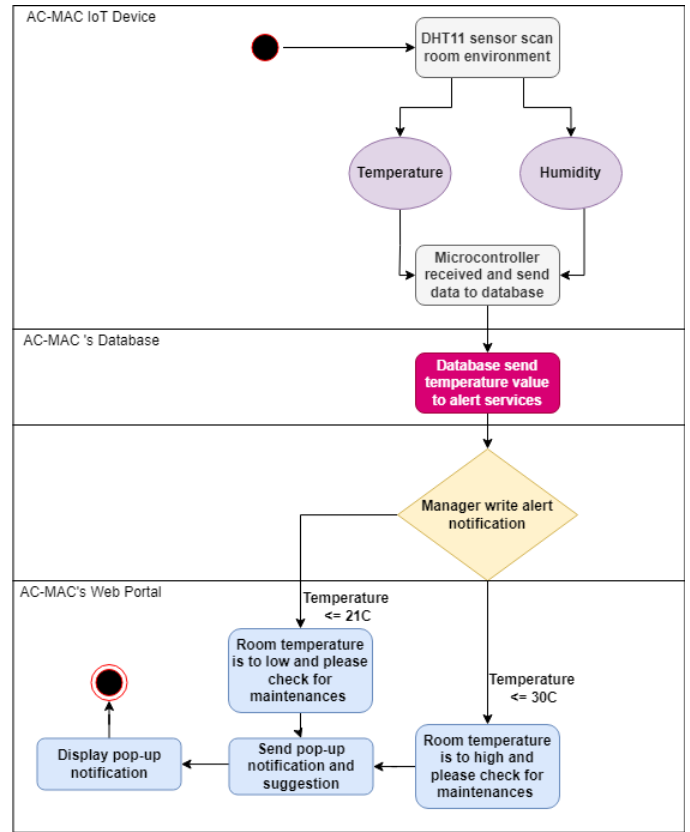

Fig 3. Get Notification Alert Module Activity Diagram

As shown in Fig. 4, AC-MAC's system architecture consists of a DHT11 component sensor used to scan the environment's temperature and humidity and send it to the database. Moreover, TSOP1738 will copy all the AC's remote-control signals to store inside the micro-controller, and the IR LED will send the wave signal to the AC to adjust the temperature. In addition, a BLDC Motor Fan will be use to act as Air Conditioning fan. The speed of fan rotation will be determined by surrounding temperature, if temperature is lower desired temperature, the speed of fan rotation will be slowing down, and if the temperature is high, the speed of fan rotation will be fast.

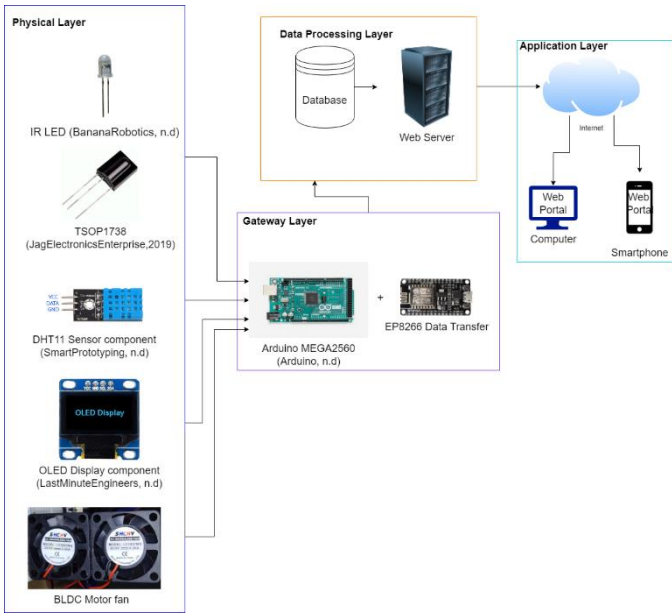

Fig 4. System Architecture Diagram

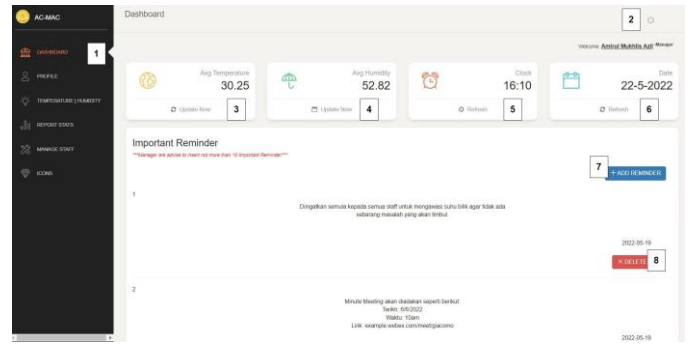

Fig 6. Manager Dashboard Interface

Fig. 7 shows the temperature and humidity table data. The table consists of five main tuples; the date, time, temperature, humidity, and heat index. To differentiate the abnormal reading temperature, for the highest temperature inside the system, the rows will be coloured red. Meanwhile, the lowest temperature will be coloured as blue, while others will be white. However, it will turn green when the user hovers over the cursor on the average row temperature.

The interface shows a table overview with the following data:

#	DATE	TIME	TEMPERATURE(°C)	HUMIDITY(%)	HEAT INDEX(°C)
1	2022-06-11	21:29:45	31.3	56.5	35.91
2	2022-06-11	21:23:01	29.2	58.6	34.90
3	2022-06-06	22:41:12	29.9	54.8	31.8
4	2022-06-06	22:42:12	28.8	54.6	29.89

Fig 7. Temperature and Humidity Interface

Fig. 8 displays a sample of the alert notification when manager creates input data on alert and action to be taken. This notification then will be displayed to all users. With this feature, server room's temperature and humidity will be able to be monitored with much detail.



Fig. 8. Alert Notification Feature

Fig. 5 showed the real physical circuit that have been built from different components.

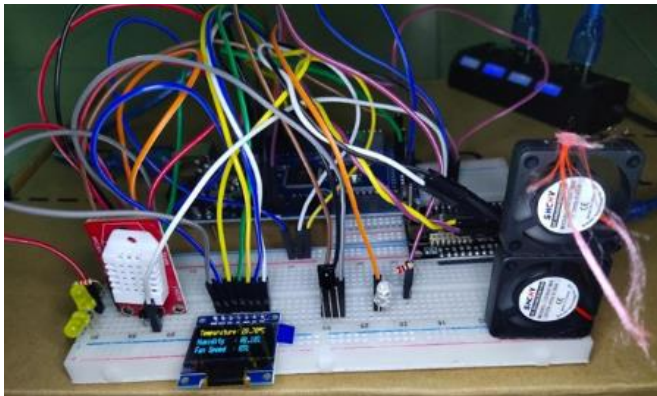

Fig 5. AC-MAC Real Circuit Diagram.

An interface must be simple to grasp and capable of achieving the understanding and objectives of the project without outside help. Hence, a well-designed graphical user interface is necessary for system development

Fig. 6 displayed when the Manager logged into the system and it will display the main dashboard which consists of the average temperature and humidity, current clock time and date, and reminder section. Label 1 is the dashboard menu option while 2 is the logout button. For the 3, 4, 5, 6 is the update and refresh button for the upper subsection. Meanwhile, 7 and 8 are only visible for the upper level such as manager and able to add reminder or delete the old reminder. Fig. 6 shows the Dashboard Page interface along with the real average temperature and humidity data from the database.

As the company grows and have more new staffs come into the department and also leave, there is a need to ensure that the staffs are included into the system. *The Manage Staff* page gives managers a way to monitor the current list of users. The information that will appear are the staff ID, name, role, phone number, email, and date created (as shown in Fig. 9).

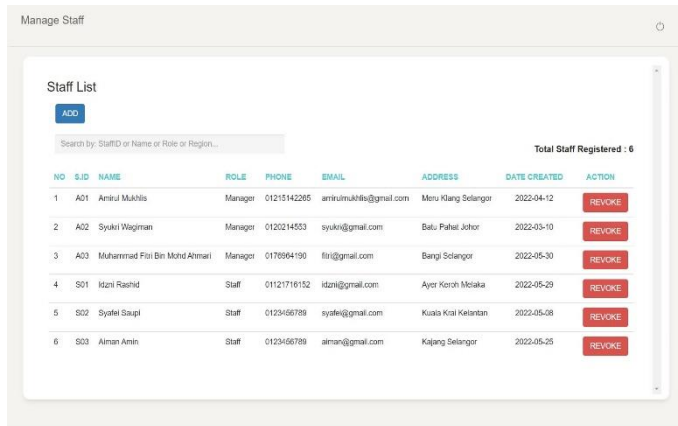

Fig. 9. Manage Staff Interface

V. TESTING AND RESULTS

User testing involves running a real user through the system's paces to check that all the system's requirements have been satisfied. Multiple users' acceptance tests were conducted with the assistance of many system testers. During this testing session, because of the project requires hardware and software involvement, user testing is conducted by video conferences via Discord Application due to distance. Thus, user testing will consist of two methods: testing via video conferences with an OGX Network Sdn. Bhd. member and testing based on example scenarios. They can however give multiple instructions to the test conductor for testing process such as instructed to register new user and search specific temperature and humidity. Feedback that has been given after user testing are used to improve the system development. Testing will be held in a room size that have one unit of AC. Generally, the testers were able to replicate the expected results for all of the features in general and suggesting that the testing was considered successful. The

testers, on the other hand, gave ideas for how to enhance the system.

ACKNOWLEDGEMENT

This work was completed with the support of the Faculty of Computing UTM academicians who gave great feedback towards the betterment of the project.

VI. CONCLUSION

The system development should be enhanced for future usage to guarantee that the system remains current with new technology and ideas that satisfy user needs. Hence, the enhancements that may be made to the system's capabilities include the various analytical processes that can provide specific scenarios for what could happen to the AC-MAC. This may assist the user in being more cautious and taking appropriate action if any problems arise in the long or short term.

REFERENCES

- [1] Deng, W., Liu, F., Jin, H., Liao, X. and Liu, H. (2014), Reliability-aware server consolidation for balancing energy-lifetime tradeoff in virtualized cloud datacenters. *Int. J. Commun. Syst.*, 27: 623-642. <https://doi.org/10.1002/dac.2687>
- [2] RackSolutions (2019). Solution to 5 Common Server Room Problems. Retrievable at <https://www.racksolutions.com/news/blog/solutions-to-5-common-server-room-problems/>, (Accessed: 12 April 2019).
- [3] Moehammad Alvan Prastoyo Utomo, Abdul Aziz, Winarno, Bambang Harjito. (2019), Server Room Temperature & Humidity Monitoring Based on Internet of Thing (IoT). *Journal of Physics: Conf. Series* 1306 012030. doi:10.1088/1742-6596/1306/1/012030.
- [4] Novak, D. (2020). Cielo Breez Plus Smart AC Controller - Compatible with Samsung Smarthings. Retrievable at <https://www.gadgetgram.com/2020/10/21/cielo-breez-plus-smart-ac-controller-full-review/#:~:text=The%20Cielo%20Breez%20Plus%20is,ACs%20and%20many%20C%20many%20more>, (Accessed: 20 October 2020).
- [5] Sharma, S., Sarkar, D. and Gupta, D. (2012). Agile Processes and Methodologies: A Conceptual Study. *International Journal on Computer Science and Engineering*. 4.
- [6] Rehkopf, M. (2021). User Stories | Examples and Template | Atlassian. <https://www.atlassian.com/agile/project-management/user-stories>. (Ac- cessed: 25 July 2021).