



## Journal of Advanced Research in Fluid Mechanics and Thermal Sciences

Journal homepage:  
[https://semarakilmu.com.my/journals/index.php/fluid\\_mechanics\\_thermal\\_sciences/index](https://semarakilmu.com.my/journals/index.php/fluid_mechanics_thermal_sciences/index)  
ISSN: 2289-7879



# Review on Flow Controls for Vehicles Aerodynamic Drag Reduction

Rafiqi Daniel Ramadhan Mariaprakasam<sup>1,\*</sup>, Shabudin Mat<sup>1</sup>, Pakharuddin Mohd Samin<sup>1</sup>, Norazila Othman<sup>1</sup>, Mastura Ab Wahid<sup>1</sup>, Mazuriah Said<sup>2</sup>

<sup>1</sup> Institute for Vehicle Systems and Engineering, Universiti Teknologi Malaysia, 81310 Skudai, Johor, Malaysia

<sup>2</sup> Faculty of Engineering, City University Malaysia, 46100 Petaling Jaya, Selangor, Malaysia

### ARTICLE INFO

#### Article history:

Received 16 May 2022

Received in revised form 20 October 2022

Accepted 30 October 2022

Available online 19 November 2022

#### Keywords:

Aerodynamics; automotive; flow control

### ABSTRACT

Reducing aerodynamic drag in automobiles has been one of the focuses in automotive industry as it will increase vehicles performance and reduce power consumption which subsequently save the environment. Drag is a force that tend to pull the vehicle backwards. Pressure drag is the major contributor to drag of vehicle which caused by lower pressure in the rear area compared to front of vehicle. When vehicle moves forward, the stagnation point occurs in the front part of vehicle. The airflow then goes over the vehicle and separate at the back due to adverse pressure gradient. Thus, flow separation is created in the rear area of vehicle as indicated by the wake. Wake is a low-pressure region that need to be shrink so that the pressure difference between the front and rear could be reduced to minimize the drag. Flow control is introduced to delay this flow separation and it has been categorized as active and passive. Active flow controls require power input while passive flow controls do not need power input. This review article will explore those studies on flow controls applied in automobiles and investigate their working mechanisms along with research gaps detected. Relative comparison of effectiveness for each flow control is unfeasible as the parameters used differs but this problem can be resolved. Standard parameters need to be used in future researches in order address the discrepancy of results obtained from numerous studies around the globe. A current flow control technique is proposed to be conducted in UTM Aerolab to further investigate this interesting flow field.

## 1. Introduction

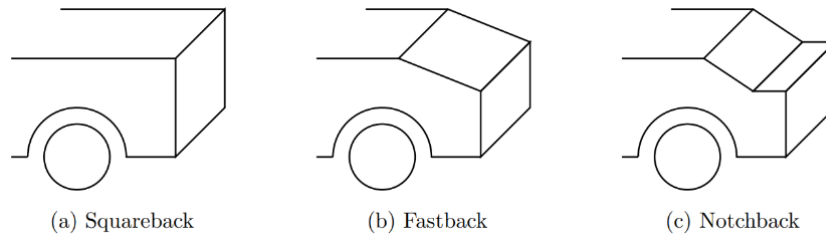
Any moving body in a fluid will subject to drag pressure drag is prevalent due to sub-atmospheric at the blunt base as explained by Pathan *et al.*, [1] even if it is a streamlined shape like airfoil as studied by Zohary *et al.*, [2]. That sub-atmospheric pressure caused by the sudden expansion at the rear vehicle [3]. This shows that rear shape in road vehicles is a significant matter and it is generally are divided into configuration as shown in Figure 1. These vehicles will have different wake behind based on the rear shape configuration. Vehicles with backlight angle will have flow as shown in Figure 2 however vehicle that has flat back will have rather symmetric wake as depicted in Figure 3. The

\* Corresponding author.

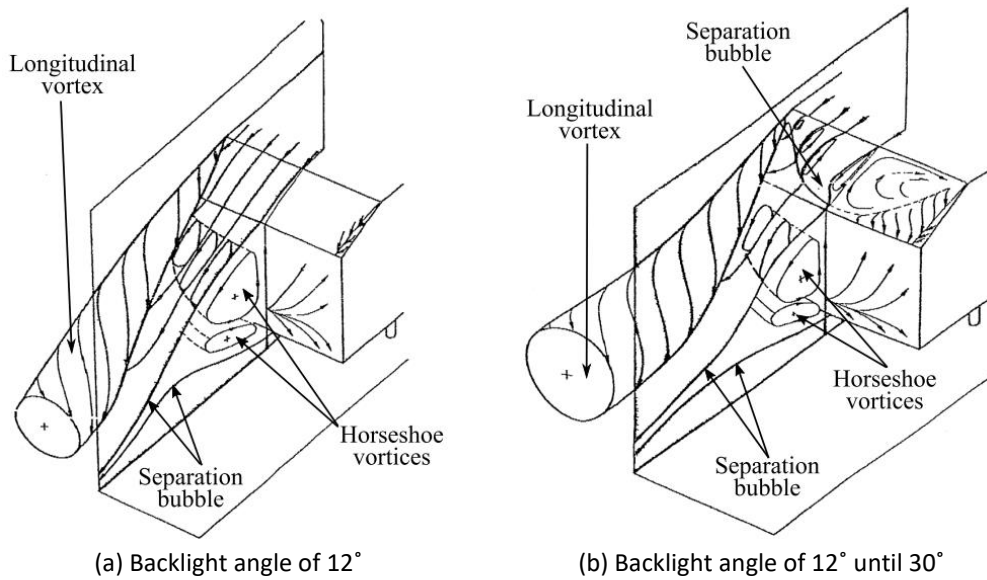
E-mail address: rafiqi@graduate.utm.my

<https://doi.org/10.37934/arfmts.101.1.1136>

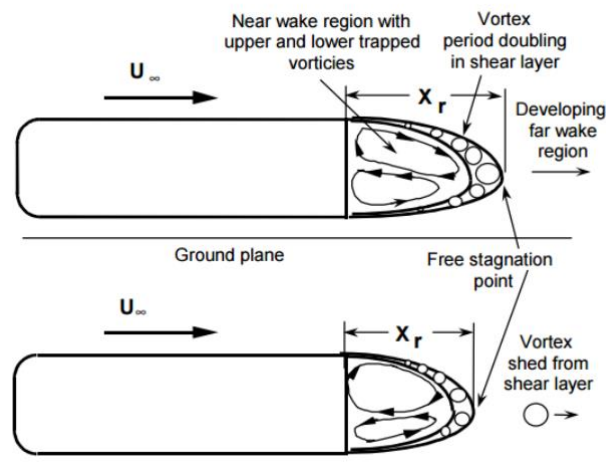
differential pressure created between front and rear of vehicles created pressure drag where the vehicle is pulled in backward direction. Reducing wake is the main focus in reducing drag as this is a low-pressure region while the front is high pressure region and flow control is the key to resolve this as it can control the flow separation either by delaying it or reducing its impact [4]. As the airspeed goes high, the drag force increased exponentially but the coefficient of drag will be reduced and stable after certain speed [5,6].



**Fig. 1.** Vehicles rear end shapes [7]



**Fig. 2.** The wake behind vehicle with backlight angle [8]

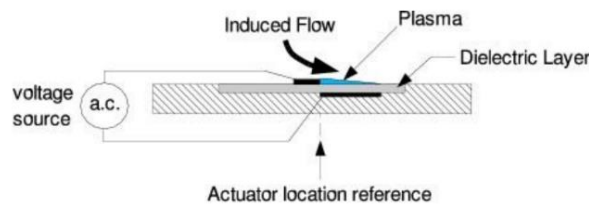


**Fig. 3.** The wake behind squareback vehicle along with its vortex shedding as viewed from side [9]

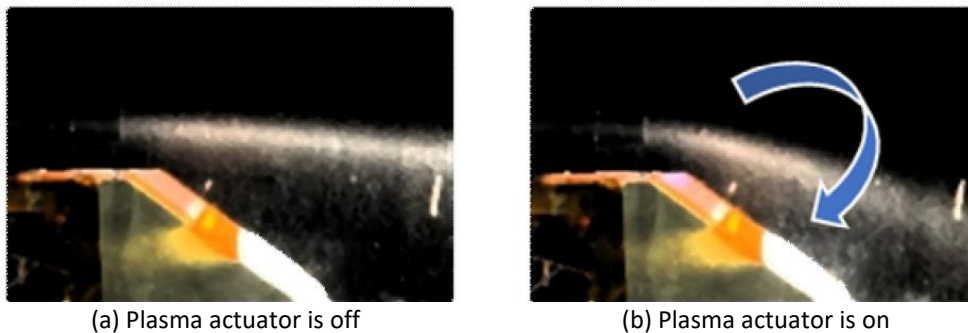
## 2. Active Flow Control

### 2.1 Plasma Actuator

According to Khalighi *et al.*, [10] the plasma actuator contains 2 electrodes with a dielectric material in between as visualized in Figure 4. One of the electrodes located below and fully covered by dielectric material and the another is exposed to air. The working principle called single dielectric barrier discharge (SDBD) where large AC voltage amplitude will be applied and it will ionize the air at the area of greatest electric potential. This typically starts at the edge of electrode that is exposed and continues over the region projected by covered electrode. Plasma actuator reduce drag by redirect the air flow around the rear edges, controlling the flow structure in the wake as shown in Figure 5. Meanwhile Hui *et al.*, [11] stated in their paper that when ions collide with neutral particles in the gas around the actuator, the local momentum of airflow in the region is increased and ionic wind is induced thus injecting momentum into the boundary layer.



**Fig. 4.** Schematic drawing of SDBD plasma actuator [10]



**Fig. 5.** Particle flow visualization at the back of Ahmed model installed with plasma actuator [10]

It was observed that the drag reduction (DR) using this flow control becoming less effective at higher wind speed due to limitation of increasing actuator voltage. Generally, the voltage required to produce the same effect (body force) scales as the square of the free-stream velocity (momentum). These studies usually use Ahmed model and low airspeed is used such as by Shadmani *et al.*, [12] that tested at 20 m/s.

Besides car, plasma actuator also been tested for truck as reported by Vernet *et al.*, [13] and they achieved similar result as Khalighi *et al.*, [10] due to similar flatback configuration. Additionally, Kim and Yun [14] also experimented plasma actuator on the train. Further study on location of these actuator can be pursued and installation of it on passive flow control also be investigated.

## 2.2 Steady Blowing

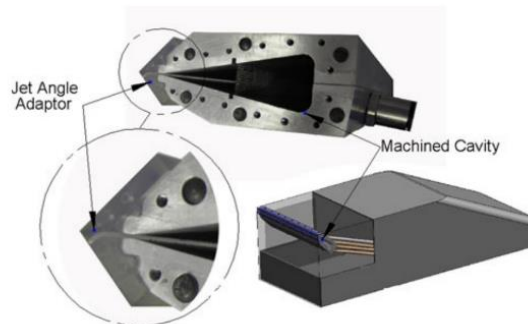
Steady blowing use steady and continuous jet of air as a deflector of the flow or momentum injection, same principle as plasma actuator. Important non-dimensional parameter in steady blowing is blowing ratio (B) and momentum coefficient ( $C_\mu$ ) or also called as forcing intensity by Bruneau *et al.*, [15]. These values are calculated using Eq. (1) and Eq. (2).

$$B = \frac{U_j}{U_\infty} \quad (1)$$

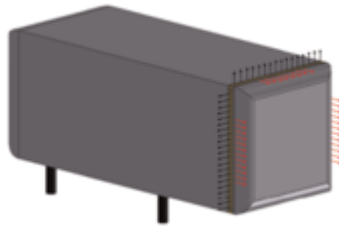
$$C_\mu = \frac{N_j \rho_j U_j^2 A_j}{q l_s \delta} \quad (2)$$

where  $U_j$  and  $U_\infty$  means blowing jet velocity and freestream velocity respectively. Whereas  $A_j$  is the area of the jet  $q$  is dynamic pressure of freestream,  $N_j$  is the total number of jets being operated,  $l_s$  is the total length of arrays actuated, and  $\delta$  is the boundary layer thickness.

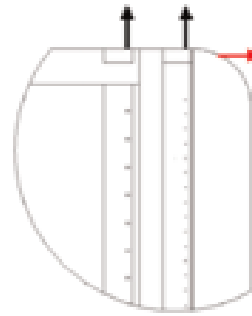
Squareback configuration of Windsor model in Figure 4 and Honda Simplified Body (HSB) in Figure 6 and Figure 7 was used by Littlewood and Passmore [16] and McNally *et al.*, [17] respectively to test steady blowing effect on DR. Both of the investigation concluded that DR will be greater with increasing momentum coefficient. In addition, Littlewood and Passmore [16] achieved best performance with the direction of blowing to be  $45^\circ$  angles downward from horizontal axis rather than other angle including normal to flow field. This is contrary with result by McNally *et al.*, [17] that better DR was obtained when blowing is normal to the flow rather than tangential to the flow (Figure 8).



**Fig. 6.** Windsor model with blowing jet at the top of rear surface [16]

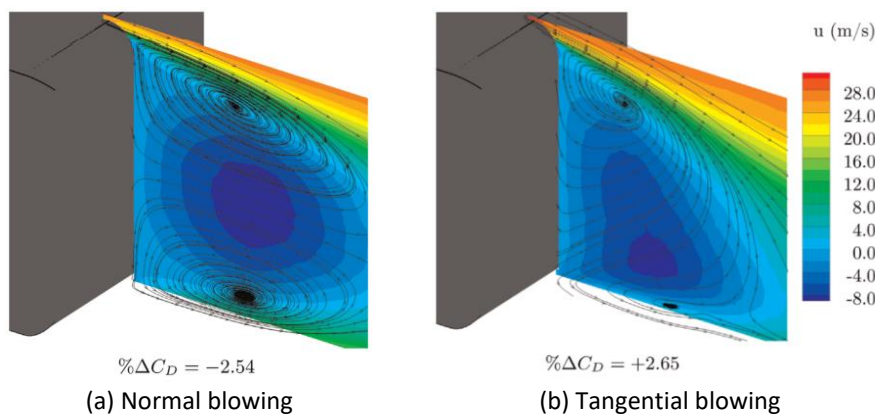


**Fig. 7.** 3D view from rear of Honda Simplified Body (HSB) along with location of actuator [17]



**Fig. 8.** Enlarged figure of orientation for actuator at rear edge of HSB where black and red arrows indicate normal and tangential blowing respectively [17]

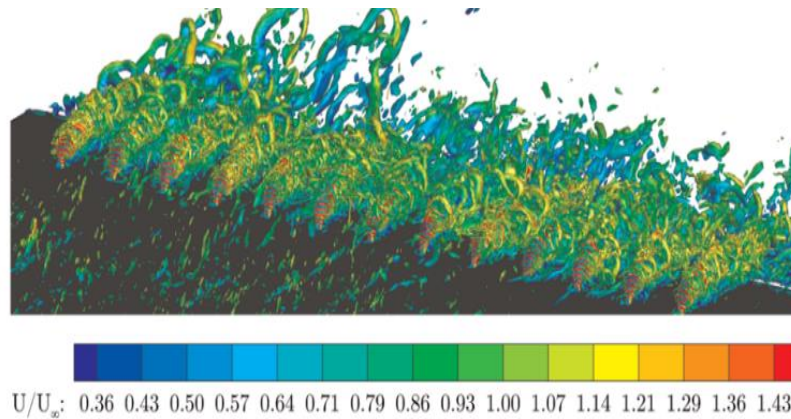
Littlewood and Passmore [16] explained that DR was attributed to smaller wake size due to deflection of upper flow downwards and smaller velocity in the lower vortex structure close to the base surface of model. Meanwhile, McNally *et al.*, [17] was working on to make the wake more symmetric that will cause low-pressure region move away from rear surface of model as characterized in Figure 9. The control implementation will reduce the difference of strength between the upper and lower recirculation region and thus normal blowing causes drag reduction while tangential causes drag increment.



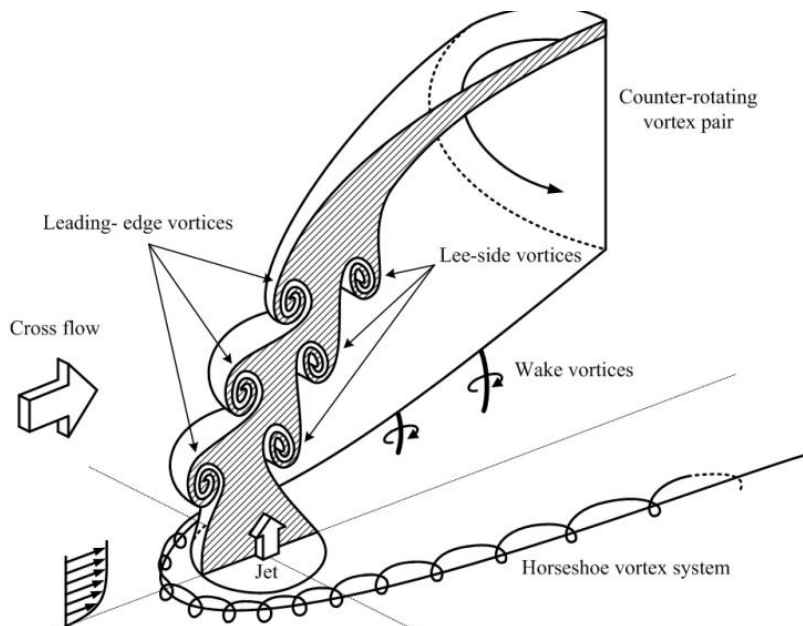
**Fig. 9.** The wake behind HSB with change of drag coefficient obtained using steady blowing [17]

Even though high  $C_\mu$  leads to high DR, the analysis made by Littlewood and Passmore [16] revealed that the power efficiency will decrease. Furthermore, the need of using compressor and storage tank will increase vehicle mass. Vehicle mass increase will create an increase in the tractive effort required to move the vehicle, and as such the smaller blowing system is needed. Moreover, they also proposed that no general rule for every bluff body can be applied. Given that there are researches to reduce the size of the wake in order to reduce drag, yet in certain applications it can be argued that a stretched wake structure would create lower drag. This may be due to the symmetry of the wake compensate the large size of the wake in reducing drag.

Experiment by Littlewood and Passmore [16] is in agreement with the results of the simulation performed by Rouméas *et al.*, [18]. Both of the studies [16,18] used higher Reynold number (Re) than [17] and Rouméas *et al.*, [18] explains that the momentum inserted into the flow at 45° angle blowing acts as a separated element and deflect the streamlines. Because of the main flow, the streamlines then tend to become realigned with the upstream direction, although a residual deviation angle remains visible in the wake. That two likeminded studies [16,18] insert blowing at the trailing of sharp end roof meanwhile McNally *et al.*, [17] use blowing upstream of a curved trailing edge of the roof. The microjet injection on top surface of model with higher blowing ratio (B = 3) by McNally *et al.*, [17] created of what seems to be vortices as shown in Figure 10. The characteristics of this blowing jet was explained in detail though earlier works by New *et al.*, [19] as in Figure 11.



**Fig. 10.** Upstream view of microjets interacting with shear layer [17]



**Fig. 11.** Vortical structure produced by normal blowing jet [19]

### 2.3 Steady Suction

Steady suction usually applied at rear edge of roof or the slant of rear windscreen by deflecting the flow downwards and forcing it to stay attached on the rear windscreen. In other words, this flow control able to reduce flow separation at rear window. In addition, most of the studies incorporate steady suction with steady blowing. This method suitable for vehicle with backlight angle rather than

squareback vehicles. This is evident by many of study using this flow control on Ahmed body with backlight angle [20-22]. The simulation of squareback Ahmed body made by Whiteman and Zhuang [23] give complete picture about performance of suction, blowing and both together. The findings are that high ratio of flow speed of suction/blowing to the freestream speed cause high DR and the value is increased with increasing Re. The method of using only suction give better DR than blowing only. Whereas combination of them will give better DR and its value is increased with higher Re. The studies revealed here did not mention about B and  $C_{\mu}$ .

Things to remark are the greatest DR will be obtained using high flow control rate with small suction area and large blowing area as the wake will be smaller. This is because blowing at the larger region cause more static pressure recovery in the wake region and thereby it reduces drag. However, if the suction is lower than certain values, it may lead to the increment of drag. This is due to the fact that weak suction intensifies the secondary flow on the rear slant surface of the model rather than affecting free stream.

To conclude, suction in boundary layer was applied in order to delay flow separation by extracting flow particles with low kinetic energy near the model surface and the sucked air was blown into the wake of the model to increase the static pressure of the wake region. Hence, suction is usually combined with blowing method to better reduce the drag. The problem with blowing and suction techniques is that the power to create the suction or blowing velocities required can be high as implied by Littlewood [24]. Some authors suggest the use of cooling air flow, or compressed air from a turbo already available on a vehicle. However, this would require ducting of the fluid to the required area, and generates losses within the ducting and packaging difficulties. Deep research into these problems is necessary to improve the ability of steady blowing and suction.

#### 2.4 Pulsed Jet

Pulsed jet works by blowing jet into the flow periodically, unlike steady blowing method that keep on blowing all the time. This makes pulsed jet is more efficient than steady blowing. Large mass flow rates used by steady blowing method would be prohibitive to directly implement the techniques to a production road vehicle. Thus, Littlewood and Passmore [16] recommended applying pulsed jet as a substitute to reduce the duty cycle of the jet.

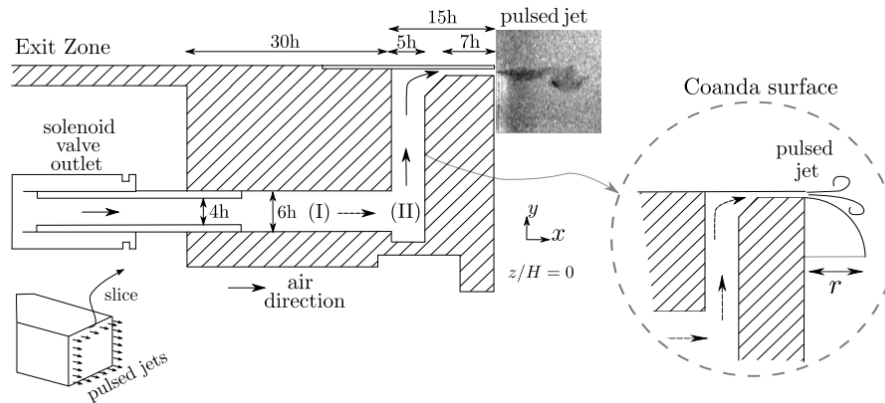
Prior to that, Bruneau *et al.*, [15] did simulation study using Ahmed body with squareback configuration to compare steady blowing with pulsed jet. They used low blowing ratio ( $B < 1$ ) and low Re, demonstrated that steady blowing achieved better DR than pulsed jet. The efficiency dropped after  $B = 0.6$  for steady blowing proving that DR performance and efficiency is a delicate task to take. In addition of momentum coefficient and blowing ratio, pulsed jet has another parameter that deal with its frequency which called as Strouhal number (St) as described by Szodrai [25] in Eq. (3).

$$St = \frac{F_j h}{U_0} \quad (3)$$

where  $F_j$  is jet frequency,  $h$  is height of vehicle and  $U_0$  is airspeed.

In proceeding years, the squareback of Ahmed body was used again in an experiment to study performance of pulsed jet by Barros *et al.*, [26]. The pulsed jet blown tangential to the freestream flow and the system installed along the rear edge of model as sketched in Figure 12. The study investigates pulsed jet at variety of momentum coefficient and Strouhal number (St) at fixed Re of  $3 \times 10^5$ . High frequency used by pulsed jet prevent growth of shear layer and lower the velocity instability in the wake causing reduced momentum fluid in the recirculation region. DR as much as

10% was achieved while frequencies close to the natural wake time scales will reduce baseline pressure.



**Fig. 12.** Pulsed jet system attached at rear edges of vehicle [26]

In comparison to other experimental study that used Ahmed body with  $35^\circ$  backlight angle by Gilliéron and Kourta [27], maximum DR achieved was 20% at fixed  $Re = 1.4 \times 10^6$  and frequency of 500 Hz. Meanwhile experimental study by Joseph *et al.*, [28] that used  $Re$  ranging in  $1.4 \times 10^6$  and  $2.8 \times 10^6$  on Ahmed body with  $25^\circ$  backlight angle obtained DR between 6 and 8%. DR achieved is depending on the geometric and jet exhaust configurations that show different sensitivity to the forcing parameters. To conclude, influence of the forcing parameters (non-dimensional frequency, injected momentum quantity) will affect the ability of pulsed jet and this is practicality limitations of the active flow control devices. Thus, it is currently ruled out for implementation on a road vehicle and instead being applied for others application. Besides the hardware system that installed, the control system also required causing overall system of DR become difficult.

## 2.5 Synthetic Jet

Synthetic jet is active flow control that does not require ducting and has zero net mass flux. If the momentum required to influence flow could be generated using this technique, it may offer an attractive solution to the problem of ducting in blowing and pulsed jet system. Mukut and Abedin [29] explains that synthetic jet actuator usually consists of orifice, cavity and piezoelectric actuator or diaphragm where flow moves back and forth through a small opening by the oscillation of diaphragm. The movement of diaphragm will momentarily suck and blow fluid across the orifice causing net mass flux in one phase of operation is zero. Therefore, the unique feature of the synthetic jet when compared to a steady blowing or pulsed jet, is that it is formed entirely from the working fluid of the flow system, so no net mass is injected across the flow boundary.

This process is often accompanied by the generation of a stream of vortices at the edges of the orifice/slot which impart finite momentum and vorticity into the surrounding fluid. Interaction of these vortical structures with the external flow field can trigger instabilities and enhance mixing in the external flow. From the reviews, there are still lack of the usage for synthetic jet on squareback model and this is still a relatively new technology worth to be pursued. Synthetic jet usually used on Ahmed body with backlight angle. For instance, Tounsi *et al.*, [30] used Ahmed model with  $25^\circ$  backlight angle and obtained maximum DR of 10% which is around the same as others [31][32]. Figure 13 described the setup of synthetic jet used in their experiment and placed it upstream of the edge between the end of the roof and the top of the rear window. Since this synthetic jet does not require



ducting and no net mass flux, this flow control became the simplest active flow control to be applied for drag reduction research.

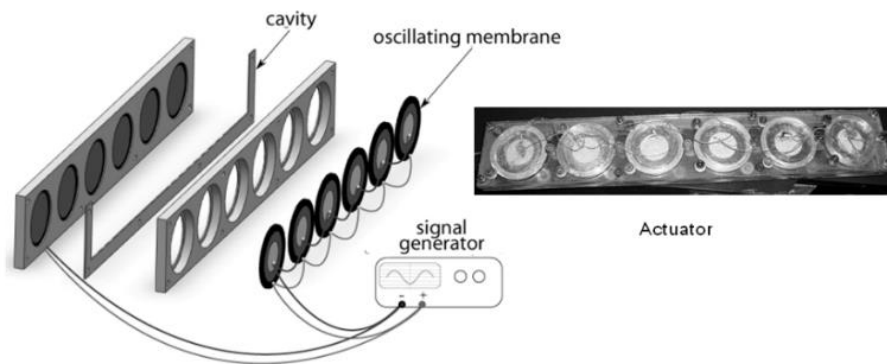


Fig. 13. Piezoelectric actuator used in experiment [30]

### 3. Passive Flow Control

#### 3.1 Spoiler

Spoiler are known for its capability to create strong downforce for vehicle hence increasing grip and stability at high speed and cornering. Spoiler usually are said to increase drag at expense of creating downforce. While it is true but, in some cases, careful design of spoiler could potentially reduce drag while doing its basic work of creating downforce. Spoiler working principle of reducing drag is different for sedan and squareback vehicles. This is due to the nature of separation flow of sedan vehicle that is different compared to squareback. Sedan vehicles have two separate recirculation region which are at rear window and rear trunk unlike squareback that has one big recirculation region. Addition of spoiler on sedan will prevent recirculation zone at the above of the rear window due to high pressure created by spoiler and studies related will be discussed in following paragraphs. According to Computational Fluid Dynamics (CFD) simulation by Rajapaksha *et al.*, [33], spoilers (Figure 14) used on Tata Manza car reduced drag up to 9% at 100 km/h speed.

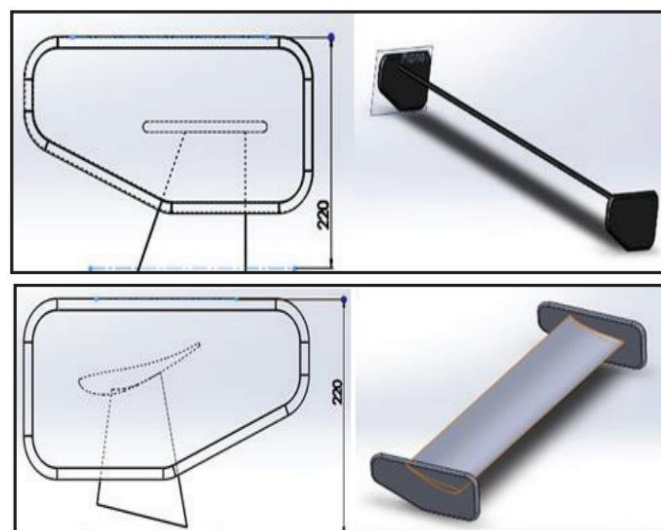
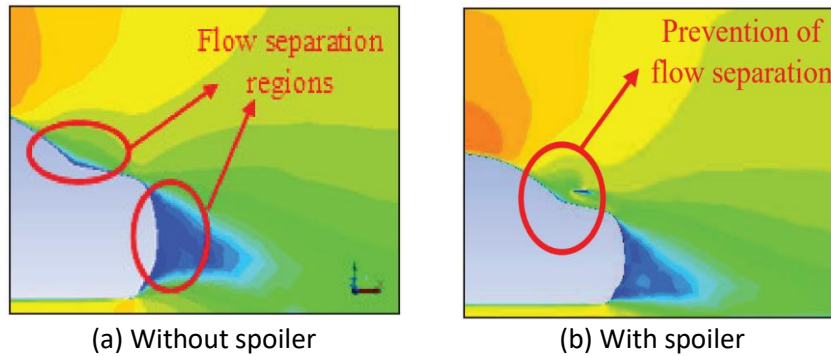


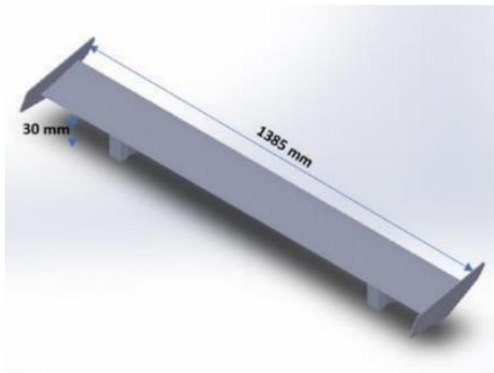
Fig. 14. Two design of spoilers that reduced drag on sedan vehicle [33]

The recirculation zone at the rear window is prevented using spoiler as illustrated in Figure 15. The sudden loss of air attached to car rear, result in large vortices. Due to these vortices, there will be a great pressure drop in the rear end of the car that creates immense pressure drag. Comparing static pressure contours, it can be observed that addition of spoiler to the car has increased the pressure at the rear end.

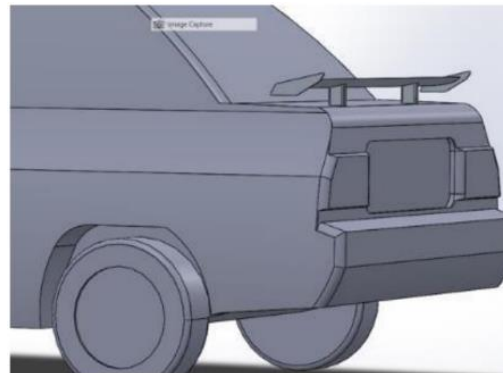


**Fig. 15.** Velocity contour at rear of Tata Manza model with and without spoiler [33]

Similar conclusions were reached by Saleh and Ali [34] as well using their own designed spoiler on Kia Pride car as shown in Figure 16 and Figure 17. They revealed that pressure distribution at the car surface is increasing due to the new stagnation point at the front of the spoiler, while the wake region pressure behind the car is increased. The spoiler obstructs the flow of air through it, thus preventing the air from pulling down, which would otherwise generate a low-pressure air envelope and turbulence behind the car that contributes to the pressure drag.

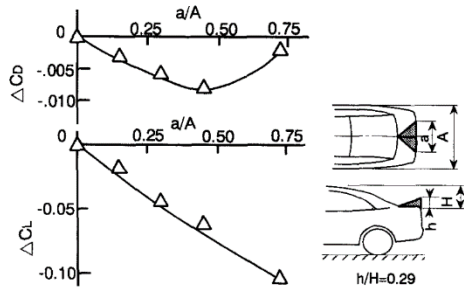


**Fig. 16.** The spoiler design used [34]

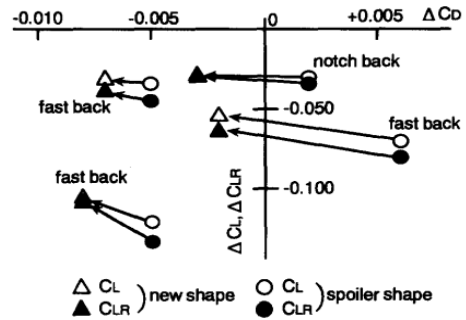


**Fig. 17.** The location of spoiler on the trunk of Kia Pride [34]

There are also other spoiler studies that have similar findings [35-37] and such researches have been pursued since last century like the one made by Mitsubishi Motors Corporation. Fukuda et al., [38] designed and developed new trigonal pyramid spoiler to be used on sedan as presented in Figure 18. They provided a detail study using CFD and wind tunnel testing to examine the new spoiler compared with conventional spoiler with the aim to lower rear lift without increasing drag and front lift as portrayed in Figure 19.

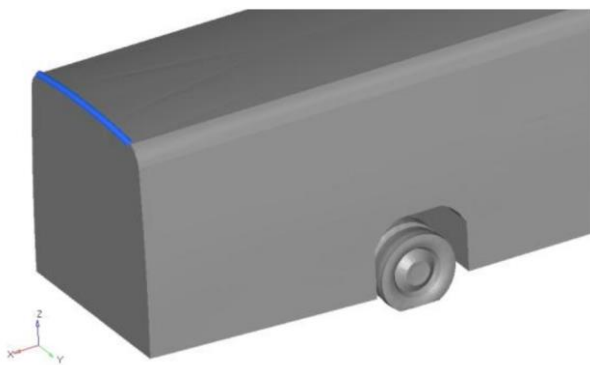


**Fig. 18.** Influence of spoiler dimension on aerodynamic coefficients of sedan car [38]

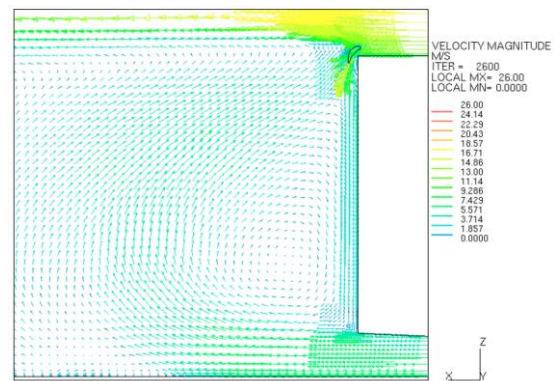


**Fig. 19.** Comparison of performance between new spoiler with conventional spoiler [38]

On the other hand, the while spoiler on sedan usually used inverted wing, the spoilers on squareback vehicle used the upright wing to reduce drag. For instance, the simulation made by Patil *et al.*, [39] tested spoiler on a generic bus model and achieved 24% DR at speed of 60 km/h. The spoiler shaped like wing is attached at rear end of roof (Figure 20) deflected the flow over the roof toward rear surface of bus (Figure 21).



**Fig. 20.** Spoiler (blue) installed at roof end of bus mode [39]



**Fig. 21.** Velocity plot at the back of bus with spoiler installed as viewed from side [39]

To sum up, the ways of spoiler used on sedan and squareback in the previous literatures are different. The typical spoiler on sedan is not suitable for squareback while the spoiler used for squareback as simulated by Patil *et al.*, [39] can be tested on sedan. That is the future recommendation for further research in spoilers' application on vehicles. Although spoiler is considered as passive flow control in reducing drag, some high-end cars applied active control on its spoiler. The active control uses hydraulic wing style spoiler at the rear end of vehicle that adjusted its height and angle. It was done to optimize the device according to speed and preference of downforce/drag. Angle and height of spoiler is vital in optimizing the lift to drag ratio. In the light of the work by Mashud and Das [36], rear spoiler cause airflow to "see" a longer, gentler slope from the roof to the spoiler, which helps to delay flow separation and the higher pressure in front of the spoiler can help reduce the lift.

### 3.2 Diffuser

Diffuser and underbody (cover plate under body) goes hand in hand in reducing drag and lift. Diffuser is a flow control device installed at the bottom rear of vehicles that works to diffuse or decelerate the airflow from bottom of vehicle which will generate pressure recovery. The angle of diffuser will sweep the flow from bottom upwards. That explains the fact that diffuser on sedan has better effect than squareback which was demonstrated in the work of Marklund and Lofdahl [40]. The squareback already has a near symmetric wake flow so the upsweep enables a pressure recovery but it does not straighten the wake.

Marklund [41] explored the effect of diffuser on sedan and wagon as shown in Figure 22. DR of the sedan car approximately 10% with the best diffuser angle and cover plates over the floor while best DR for the wagon car was 2–3% and the optimum was at a smaller diffuser angle. Flow analysis of the wake shows how important it is the wake is balanced. The diffuser generates a pressure recovery for both sedan and wagon, but for the sedan it also made the wake more symmetric. This combined effect is why the diffuser generates better drag reduction for the sedan.

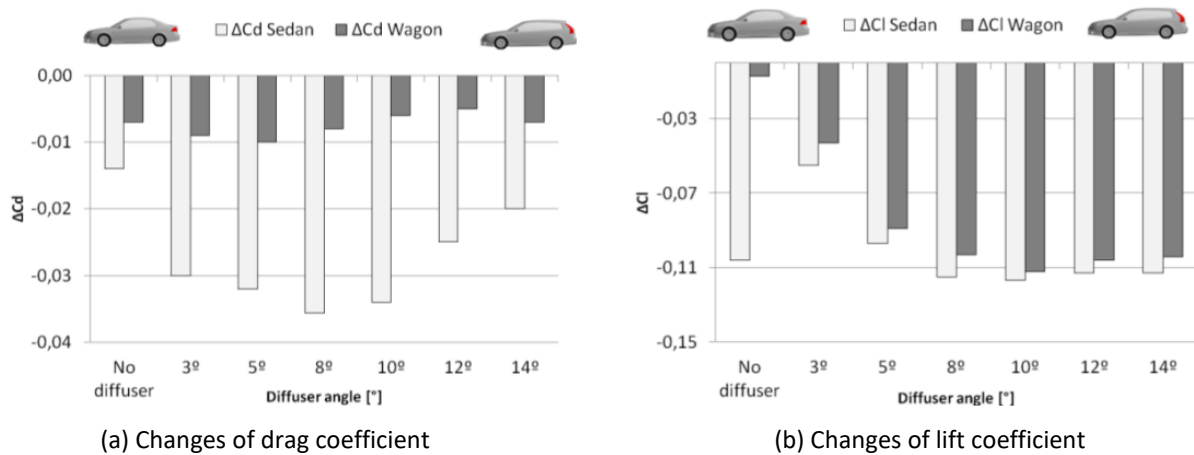
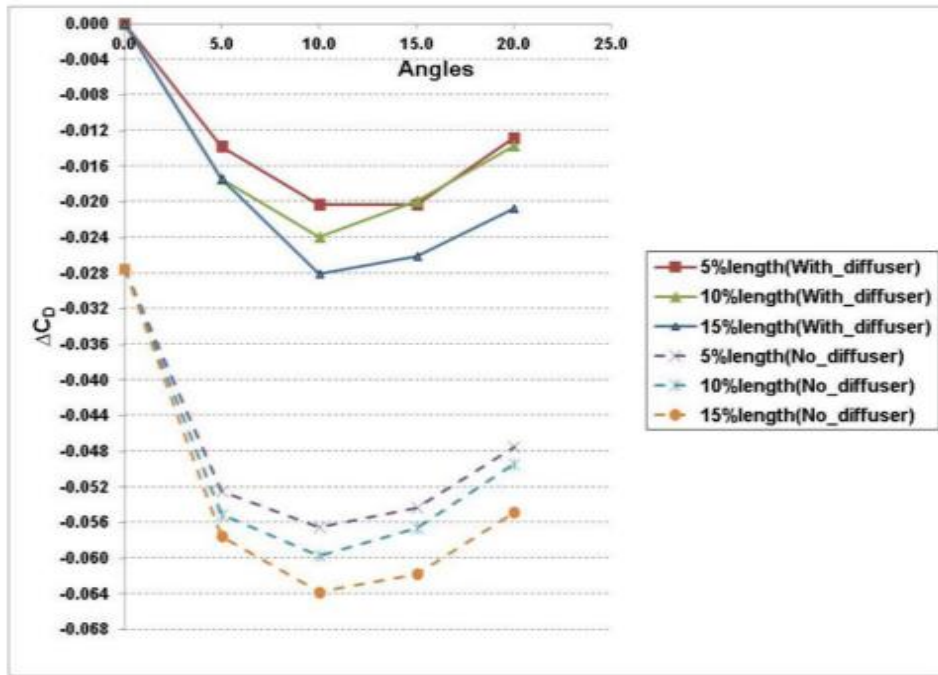


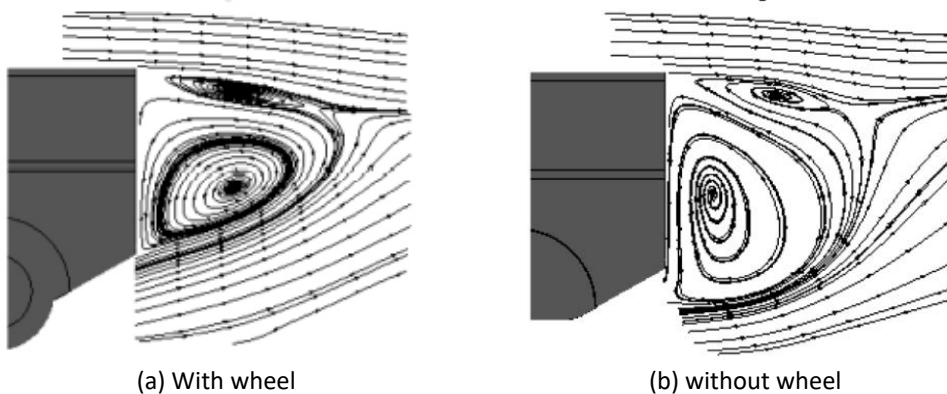
Fig. 22. Drag and lift coefficient changes due to diffuser angle [41]

The above drag results for wagon are in accordance with subsequent study by Palaskar [42] where he inspected the squareback model with rather large 10° diffuser and tapering at rear edges of model. The result as shown in Figure 23 shows that large angle diffuser actually increases the drag and it was claimed due to non-cancellation of strong vortices generated because of diffuser and rear wheels of model. Zuan *et al.*, [43] also experimented with diffuser installation on Proton Persona model and diffuser angle of 6° yield the lowest coefficient of drag.



**Fig. 23.** Drag coefficient for squareback model with and without 10° diffuser along with tapering [42]

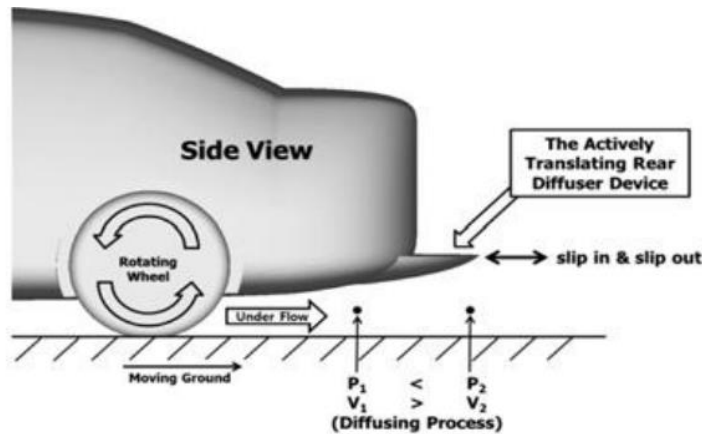
A detailed study using experiment and simulation on Sport Utility Vehicle (SUV) by Wood *et al.*, [44] shows how presence of wheel affect the flow under vehicle which subsequently impact the ability of diffuser. Their Particle Image Velocimetry (PIV) results revealed that the flow stay attached on the 30° diffusers when the wheels are present. Meanwhile, the flow did separate when the wheel is absent and the comparison is depicted in Figure 24. Therefore, it can be concluded that diffuser for squareback vehicles can be further examined about its angle by applying more realistic situation such as using wheel and moving ground. Unlike other flow control that typically attached on top of vehicle, diffuser is the only one that is applied at bottom of vehicle. Hence, more realistic approach needed to test the real capability of diffuser since there is multiple intrusion at bottom compared to upper part of vehicle.



**Fig. 24.** PIV result at back of SUV model with wheel and without wheel [44]

Similar as spoiler, high-end cars also applied active control on diffuser to optimize drag reduction at different speed. An actively moving diffuser where a translating arc-shaped device is installed under the rear bumper of the passenger car as shown in Figure 25. The device is rounded to maintain a smooth, streamlined rear underbody shape to obtain a greater diffusion effect when it is fully

extracted and control the rear flow of the automobile to reduce the aerodynamic drag. The rear flow of car will change when the diffuser slips out from bumper.



**Fig. 25.** Active diffuser installed under rear bumper of high-end car [45]

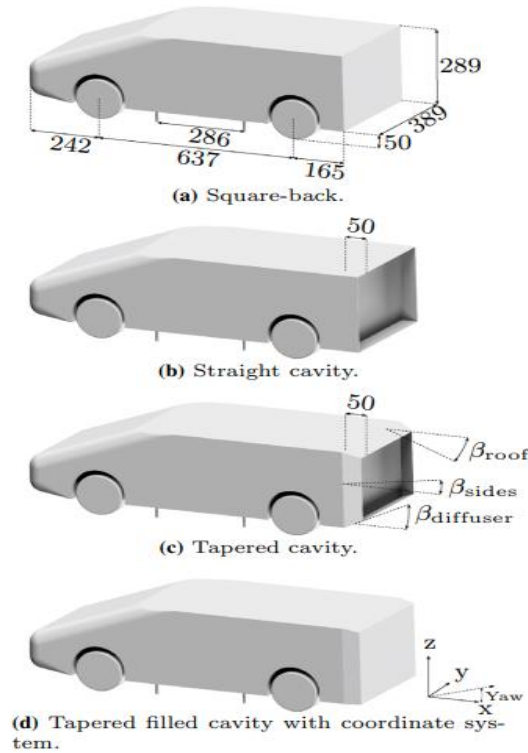
### 3.3 Rear Extension

This type of passive flow control includes tapering, flap, tail plate, boat tailing and rear fairing. All these are the same in a way that there is an extension on the rear edge of the vehicle that can delay flow separation at rear end or redirect the flow into the wake. As mentioned by Altaf *et al.*, [46] the rear extended plates and flaps installed have similar effect as boat-tail. This act to mimic boat-tailing making all these are considered as same category. There are some instances where tail plate installed at roof edge also being considered as spoiler [47][48].

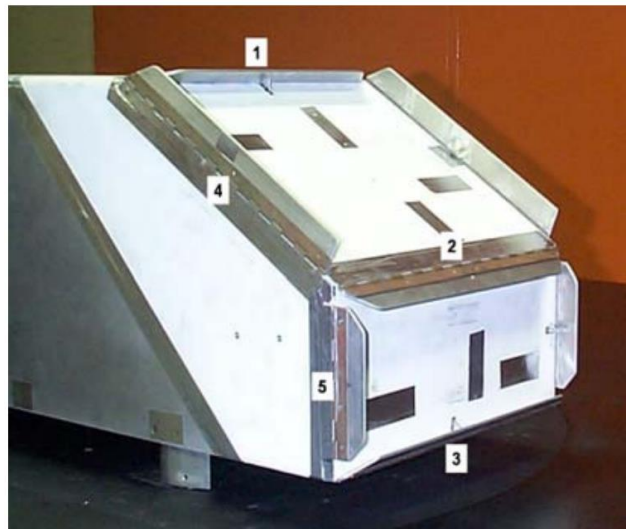
Group of researchers from Loughborough University and associates conducted variety of experiments about this rear extension on squareback model [49-52]. The investigation used squareback vehicle such as Windsor model and generic SUV model and tapering is used on the rear of model such as shown in Figure 26.

Those studies found that angle of  $10^\circ$ - $15^\circ$  yield the best drag reduction depending on the parameter such as size of the plate, yaw angle, tapered cavity or filled tapered cavity. That angle works for both upper and side extension. This is as explained by renowned study of Ahmed body where the freestream flow is stay attached until angle of around  $12^\circ$ . The result matches very well with recent simulation study in investigating the flap sizes, shapes and its angle while being installed at the rear edge [53-55]. Hence, any tapering or tail plate installation work best for squareback vehicle at  $10^\circ$ - $15^\circ$  as it was able to deflect the attached flow into the wake behind the body. However, tapering of underbody only work to reduce drag at lower angle as discussed in previous chapter about diffuser.

The way of rear extension work bit different for vehicle with backlight angle. While the tail plate installed at roof end (plate 1) does reduce drag, but flap installed on the slant edge (plate 4) proved to be more effective in reducing drag. Experiments on Ahmed body with  $30^\circ$  backlight angle executed by Beaudoin and Aider [48] gave full understanding of how the drag is changed with different position and angle of flap on body as in Figure 27. They explained in detail that the side flap blocked the longitudinal vortices, causing separation bubble to grow freely without great depression of longitudinal vortex. In short, suppressing the large of longitudinal vortices at the side edge of the slant section are one of the mechanisms to reduce drag for vehicle with backlight angle as concluded by Cheng and Mansor [56].



**Fig. 26.** Configuration of the Windsor model with rear extension used in the studies



**Fig. 27.** Rear view of the Ahmed model installed with tail plates at edges [48]

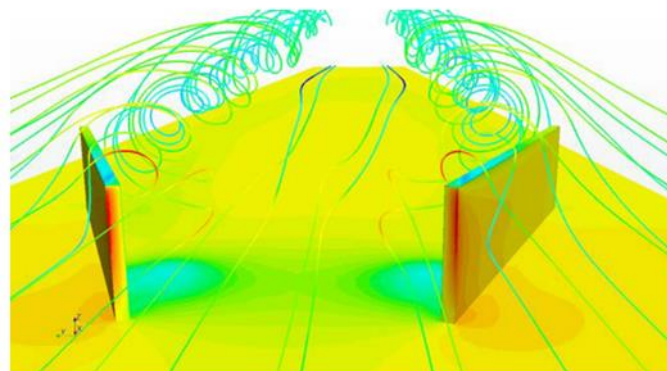
The same conclusion also made by Tian *et al.*, [57] in their CFD simulation for Ahmed body with backlight angle of  $25^\circ$ . The best drag reduction obtained was 21.2% for flap angle of  $80^\circ$  from slant surface while Beaudoin and Aider [48] obtained 17.7% maximum DR for flap angle of  $75^\circ$ . The slight difference may due to different backlight angle and  $Re$  used by Beaudoin and Aider [48] is  $2.4 \times 10^6$  while Tian *et al.*, [57] used  $Re$  of  $4.29 \times 10^6$ . The experiment by Beaudoin & Aider [48] also combined all flap configuration and obtained 25.2% drag reduction.

Addition of other flow control also could enhance the ability of tail plate to deflect more flow at higher angle. Currently, the tail plate only able to deflect flow at relatively low angle as higher angle will cause the flow to separate from the surface of tail plate. However, if there is other flow control added upstream of tail plate, the flow will stay attached on tail plate at higher angle. Hence, more flow can be deflected to the rear surface of vehicle and reducing size of wake.

Even though a fixed angle of flap could reduce drag at wide range of windspeed, this passive flow control also subjected to active control system as that of spoiler and diffuser. There are experimental studies that incorporate servomotor to adjust angle of the flap to better optimize its performance such that by Beaudoin and Aider [48]. Another instance is where Altaf *et al.*, [46] reported that incorporating active control on small flap is better than larger flap with no active control. This is due to the flap need different angle of inclination at different windspeed in order to maximize drag reduction which is the same concept as spoiler and diffuser. Besides of reducing drag, addition of these rear fairing may have influence on vortex induced vibration (VIV) as Karman vortex shedding happens because of the flow separation as reported by Esa *et al.*, [58]. Thus, investigation of this issue can be carried out in future works.

### 3.4 Vortex Generator

Vortex generator (VG) is a type of passive flow control that will increase momentum of the flow in the boundary layer. As its name stands, it creates small streamwise vortices so that the flow will have enough momentum to prevent adverse pressure gradient and subsequently avoid flow separation. The ability of VG to delay flow separation is the same for squareback and sedan vehicle. The streamwise vortices created due to differential pressure between two surfaces and the flow will spill over to the other side that has lower pressure as shown on Figure 28.



**Fig. 28.** Formation of vortices by rectangular plate VG [59]

In 2004, a group of engineers from Mitsubishi published a technical paper about the use of bump-shaped and delta-shaped VG on Mitsubishi Lancer Evolution VIII [60]. That research found that delta-shaped VG is the most effective in reducing drag and explained in detail about the mechanism of VG. They also highlighted that optimized length-to-height ratio of VG is 2 while interval-to-height ratio is 6. Whereas the yaw angle of VG should be  $15^\circ$  which is consistent with subsequent studies. This technical paper has been cited a lot in other papers showing this study has led lot of researchers to study delta-shaped VG in depth.

For instance, Yadav *et al.*, [61] modified the delta VG and used CFD to study its effect on Hyundai i30 hatchback car. In 2019, Selvaraju and Parammasivam [62] explored the effect of delta VG on SUV



model at different wind speed. VG at different wind speed give different drag reduction, and thus location of VG on the roof need to move to achieve better result. This result agreed with the outcome made by Zakher *et al.*, [63] where they placed the VG on the trunk instead of on the roof like many other studies. The reason behind this is vortex generator need to be placed before point of flow separation and separation point happen faster when the air speed is high. Therefore, the flow separation targeted to be reduced by Zakher *et al.*, [63] is the one behind the trunk instead of the rear windscreen.

Further study about delta VG is about change of its yaw angle made by Rahman and Thiyagarajan [64] and Shankar *et al.*, [65]. Rahman and Thiyagarajan [64] mentioned that VG diverging to the flow field is the best configuration to reduce drag. The difference of those papers mentioned are the type of model used, the wind speed and some slight modification of delta-shaped VG. Moreover, the delta VG also been combined with other passive flow control such as spoiler [34][66]. Both of the research agrees that combination of VG with other passive flow control will reduce drag more effectively.

On the other hand, there are few studies about other cross-section shape of VG such as the one made by Islam *et al.*, [67] where they experimented about hexagon-shaped VG (Figure 29) and by Pujals *et al.*, [68] which experimented cylinder-shaped VG (Figure 30). Sen *et al.*, [69] also analyzed four profiles of VG which are parabolic, gothic, delta and rectangular on generic sedan car model. He concluded that gothic VG is the best type according to CFD and experiments. There were also CFD study about to reduce drag and prevent flow separation on aircraft wing that used similar VG types (Figure 31) as Sen *et al.*, [69]. That study by Vinodhini *et al.*, [70] concluded that delta VG yield better drag reduction. Besides installing VG on roof, VG also been installed at bottom of vehicle to investigate its influence on ground effect in a series of experiments [71-73].

Vortices will be created when there is disturbance is the flow for example the existence of dimple in creating vortex also been studied to reduce drag coefficient of a cylinder [74]. Furthermore, some active flow control also acts as VG such as blowing at certain configuration that will create vorticity also may be called vortex generator jet [13][17][28]. Latest research on VG incorporated plasma actuator on its side and the result shown momentum injection of that dual side plasma vortex generator (DSPVG) is stronger than conventional VG [75]. These shows that the effort of generating vorticity to enhance boundary layer mixing that leads to delay in flow separation is prevalent in both active and passive device making it a very interesting field to be pursue.

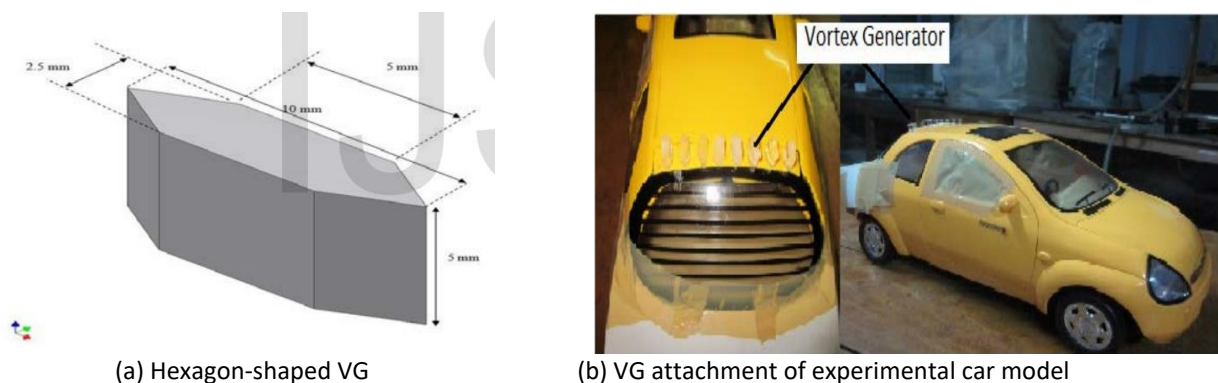
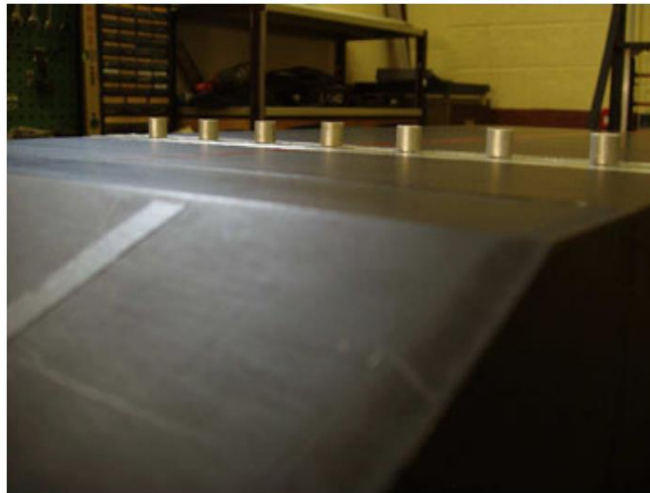
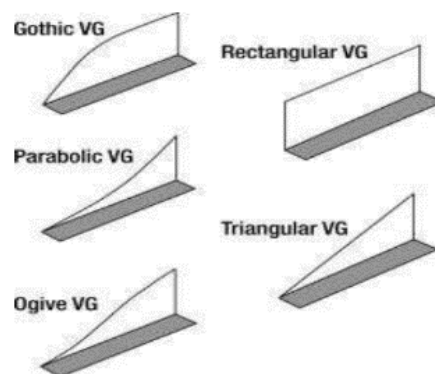


Fig. 29. Hexagon VG used in experimental study [67]



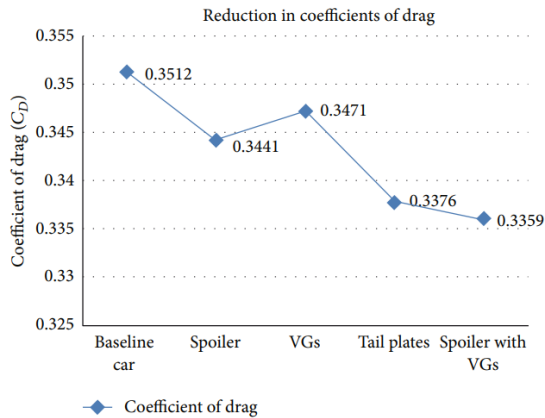
**Fig. 30.** Cylindrical VG used at rear roof of an Ahmed model with backlight angle [68]



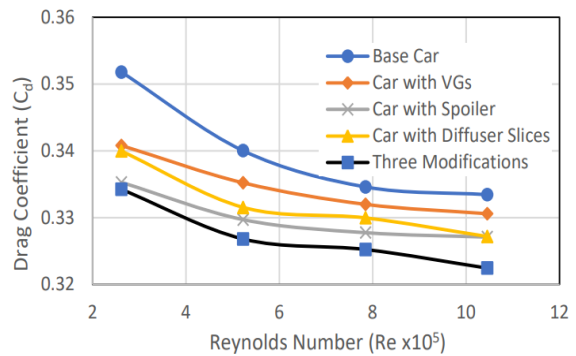
**Fig. 31.** Example of different profiles of VG used in research [70]

#### 4. Combination and Comparison of Flow Controls

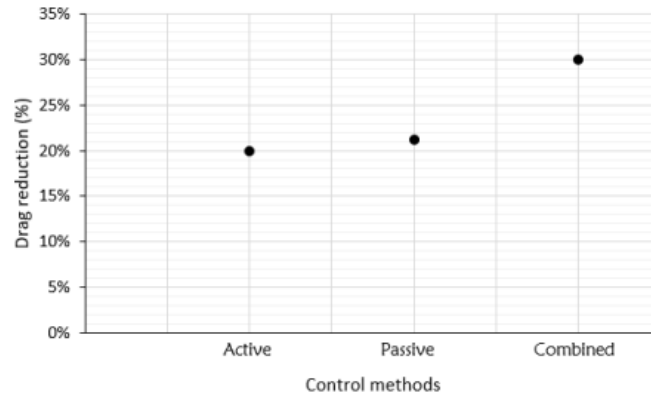
There are also several authors did combination of flow controls to further reduce the drag on sedan [34,76-78]. The results proven to be able to reduce more drag on sedan vehicle as shown in Figure 32 and Figure 33. Review by Mukut and Abedin [29] also agrees with this and it is found that active flow control has fairly the same ability as passive flow control as shown in Figure 34 indicating the reason why vehicle on roads nowadays still using passive flow control instead of active one.



**Fig. 32.** Change of drag coefficient using different passive flow control [77]



**Fig. 33.** Reduction of drag coefficient for different type of modifications of sedan car at different Re [34]



**Fig. 34.** Highest contribution of DR for different flow controls [29]

## 5. Unresolved Issues on Vortex Generator

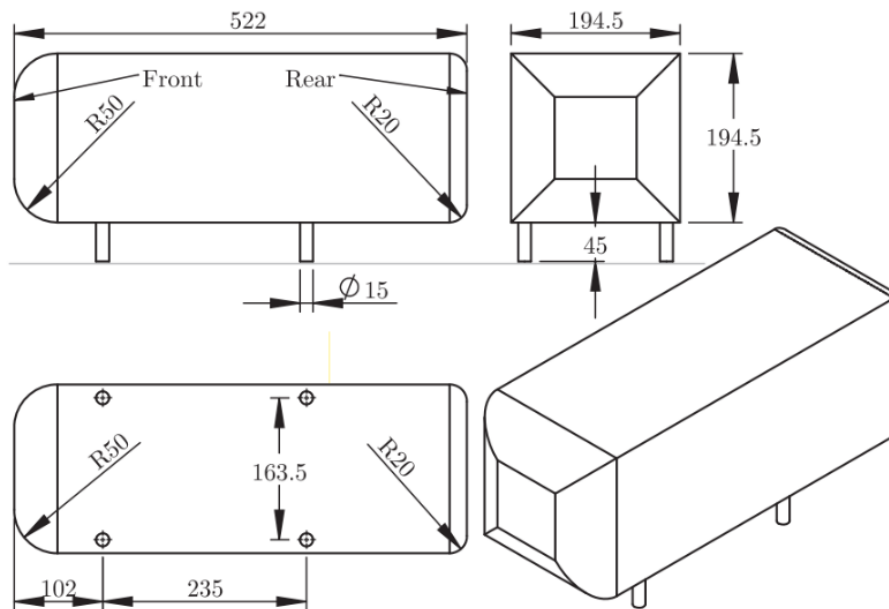
VG also can be explored more to determine the best shape and it has large application in controlling the flow everywhere. It is imperative to have the airflow attached in order for the flow control to work. The passive flow control usually installed at rear end where the flow might already separate and reducing the performance. Addition of VG also will improve the ability of other flow control located downstream. Among all shape tested, the airfoil shaped is not yet been tested and this will be investigated. Furthermore, there are lack of experimental flow visualization of the vehicle model with VG along with detailed pressure mapping around the model. The reviews found that experimental pressure mapping of model with VG is not detailed which it is not shown where did the VG changed pressure distribution around the rear vehicle. Because of that, VG is chosen to be further examined on a generic squareback model. Besides that, there is still lack of study to investigate the vortex induced vibration on vehicle. Presence of this flow controls may reduce this VIV and further research on vibrations in vehicles equipped with flow control is needed.

It is also found that researches about flow control did not incorporate similarity flow or Reynold sweep in order to compare the results with each other. Low velocities were often used in the studies as stated in review paper by Szodrai [79], and drag reduction are more significant in low airspeed. For valid study, Reynolds number must match the driving condition, thus these researches could not be compared in order to accurately see which flow control is the best in reducing drag as the

parameters used are different [80]. Besides that, boundary layer also was not considered in most of experiments. For vehicle to be tested experimentally in a wind tunnel with no moving floor, there should be a boundary layer scrapper [81] or place the model at a distance above the floor [82] to ensure the model is outside boundary layer as in real application.

## 6. UTM Aerolab Research Program

To solve some issues mentioned previously, VG experimental study will be carried out on a generic squareback model. It is a squareback model introduced for aerodynamic research with cooperation from Honda R&D firstly introduced by McNally *et al.*, [17] as shown in illustrated in Figure 35. This model will be used in this research rather than original squareback Ahmed body. Squareback Ahmed body has sharp trailing edge while this model modified this with using rounded trailing edge. This curved surface provides Coanda effect and also better resemble real road vehicle. There will be two types of VG tested which is the typical delta and airfoil NACA0012 shaped as in Figure 36.



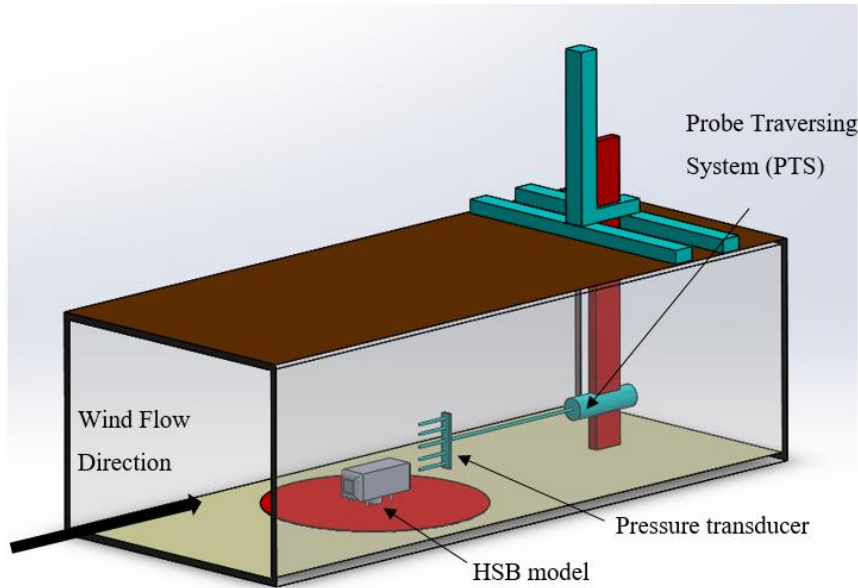
**Fig. 35.** Technical drawing of HSB with dimensions in mm



**Fig. 36.** The attachment of VG on model as viewed from above

The experiment will be carried out in UTM Aerolab wind tunnel with  $2 \times 1.5$  meter test section as illustrated in Figure 37. The airspeed for the test will be determined from Reynold sweep and yaw angle is varied with interval of  $5^\circ$ . There are three stages of experiments will be carried out on the model. The first experiment is the test of only the vehicle model without any VG which is called clean model. The second experiment is testing with delta VG installed at rear roof of the model. The final experiment is the testing with airfoil NACA0012 installed at the same position. For each experiment, several measurement techniques namely force measurement, surface pressure measurement, pressure mapping and flow visualization will be employed on the model. The results of these three

configurations will be compared to obtain the effectiveness of the VG. These experiment procedures are summarized in Table 1.



**Fig. 37.** Experiment setup in the Universiti Teknologi Malaysia-Low Speed Tunnel closed circuit

**Table 1**

The experiment procedures

| Experiment test | Parameter  |
|-----------------|--|
| Clean model     | The airspeed will be determined from Reynold sweep<br>Yaw angle: $-20^{\circ}$ , $-15^{\circ}$ , $-10^{\circ}$ , $-5^{\circ}$ , $0^{\circ}$ , $5^{\circ}$ , $10^{\circ}$ , $15^{\circ}$ , $20^{\circ}$<br>Measurement techniques:<br>i. Force measurement<br>ii. Surface pressure measurement<br>iii. Pressure mapping<br>iv. Flow visualization |
| Model with VG   | The airspeed will be determined from Reynold sweep<br>Yaw angle: $-20^{\circ}$ , $-15^{\circ}$ , $-10^{\circ}$ , $-5^{\circ}$ , $0^{\circ}$ , $5^{\circ}$ , $10^{\circ}$ , $15^{\circ}$ , $20^{\circ}$<br>Measurement techniques:<br>i. Force measurement<br>ii. Surface pressure measurement<br>iii. Pressure mapping<br>iv. Flow visualization |

## 7. Conclusion

This review paper summarized the flow controls used in automotive that can reduce pressure drag. Passive and active flow control technique have their own advantages to reduce drag on automobile. However, active flow control requires complex control system compared to passive flow control that work by attaching it on the vehicle. Reducing the size of wake due to flow separation will reduce drag but making the wake more symmetric also proven to reduce drag. Active flow control may need further research to prove itself to be superior to passive flow control. These flow control delay flow separation by momentum injection thus quantification of it need further investigation. Several issues arisen also been highlighted and suggestion has been mentioned which include the

use of standard model and Reynold sweep. Selection of model, Reynold number and other design parameters have influence on the findings of aerodynamic researches. The position of flow control also can be optimized and combined in order to further reduce the drag. Other than applying flow control, the drag also been reduced by designing more streamline vehicle, improved engine and others. Based on the literature review, VG is the most versatile flow control technique that can be performed on automobile. The data from experiments should provide a very comprehensive results on the effects of flow control on a generic squareback vehicle model.

### Acknowledgement

This research was funded by the Universiti Teknologi Malaysia research Grant (Grant no: 20J62). Special acknowledgement to the technical staff of the Universiti Teknologi Malaysia Aerolab.

### References

- [1] Pathan, Khizar Ahmed, Prakash S. Dabeer, and Sher Afghan Khan. "Investigation of base pressure variations in internal and external suddenly expanded flows using CFD analysis." *CFD Letters* 11, no. 4 (2019): 32-40.
- [2] Zohary, Aideal Czar, Waqar Asrar, and Mohammed Aldheeb. "Numerical Investigation on the Pressure Drag of Some Low-Speed Airfoils for UAV Application." *CFD Letters* 13, no. 2 (2021): 29-48. <https://doi.org/10.37934/cfdl.13.2.2948>
- [3] Khan, Sher Afghan, Abdul Aabid, Fharukh Ahmed Mehaboobali Ghazi, Abdulrahman Abdullah Al-Robaian, and Ali Sulaiman Alsagri. "Analysis of area ratio in a CD nozzle with suddenly expanded duct using CFD method." *CFD Letters* 11, no. 5 (2019): 61-71.
- [4] Gandhi, Yash Oza1 Aatifhusain Sulaimani2 Harsh, and Arvind Pisharoty4 Jay Mandalia. "Review on Vehicle's Aerodynamic Drag Reduction."
- [5] Saputra, Yudi. "Body Shape Selection of" Bono Kampar" For Urban Concept Student Car Formula to Fulfill Indonesian Energy-Saving Standards ("KMHE") with Aerodynamic Analysis." *CFD Letters* 12, no. 12 (2020): 104-114. <https://doi.org/10.37934/cfdl.12.12.104114>
- [6] Meile, Walter, Günter Brenn, Aaron Reppenhausen, Bernhard Lechner, and Anton Fuchs. "Experiments and numerical simulations on the aerodynamics of the Ahmed body." *CFD letters* 3, no. 1 (2011): 32-39.
- [7] Varney, Max. "Base drag reduction for squareback road vehicles." PhD diss., Loughborough University, 2019. <https://doi.org/10.26174/thesis.lboro.11823759.v1>
- [8] Ahmed, Syed R., G. Ramm, and Gunter Faltin. "Some salient features of the time-averaged ground vehicle wake." *SAE Transactions* (1984): 473-503. <https://doi.org/10.4271/840300>
- [9] Sims-Williams, D. B., R. G. Dominy, and J. P. Howell. "An investigation into large scale unsteady structures in the wake of real and idealized hatchback car models." *SAE transactions* (2001): 1197-1208. <https://doi.org/10.4271/2001-01-1041>
- [10] Khalighi, Bahram, Joanna Ho, John Cooney, Brian Neiswander, Thomas C. Corke, and Taeyoung Han. "Aerodynamic drag reduction investigation for a simplified road vehicle using plasma flow control." In *Fluids Engineering Division Summer Meeting*, vol. 50282, p. V01AT13A014. American Society of Mechanical Engineers, 2016. <https://doi.org/10.1115/FEDSM2016-7927>
- [11] Hui, Zheng, Xingjun Hu, Peng Guo, Zewei Wang, and Jingyu Wang. "Separation flow control of a generic ground vehicle using an SDBD plasma actuator." *Energies* 12, no. 20 (2019): 3805. <https://doi.org/10.3390/en12203805>
- [12] Shadmani, Shahab, SM Mousavi Nainiyan, Ramin Ghasemiasl, Masoud Mirzaei, and S. G. Pouryoussefi. "Experimental study of flow control over an Ahmed body using plasma actuator." *Mechanics and Mechanical Engineering* 22, no. 1 (2018): 239-252. <https://doi.org/10.2478/mme-2018-0021>
- [13] Vernet, Julie A., Ramis Örlü, David Söderblom, Per Elofsson, and P. Henrik Alfredsson. "Plasma streamwise vortex generators for flow separation control on trucks." *Flow, turbulence and combustion* 100, no. 4 (2018): 1101-1109. <https://doi.org/10.1007/s10494-018-9891-9>
- [14] Kim, T., and S. Yun. "Aerodynamic drag reduction of 3D train model using dielectric barrier discharge plasma actuators." In *Proceedings of the 21th International Symposium on Plasma Chemistry (ISPC 21)*, Cairns Convention Centre, Queensland, Australia, pp. 4-9. 2013.
- [15] Bruneau, Charles-Henri, Emmanuel Creusé, Delphine Depeyras, Patrick Gilliéron, and Iraj Mortazavi. "Coupling active and passive techniques to control the flow past the square back Ahmed body." *Computers & Fluids* 39, no. 10 (2010): 1875-1892. <https://doi.org/10.1016/j.compfluid.2010.06.019>

- [16] Littlewood, R. P., and Martin A. Passmore. "Aerodynamic drag reduction of a simplified squareback vehicle using steady blowing." *Experiments in fluids* 53, no. 2 (2012): 519-529. <https://doi.org/10.1007/s00348-012-1306-4>
- [17] McNally, Jonathan, Erik Fernandez, Gregory Robertson, Rajan Kumar, Kunihiko Taira, Farrukh Alvi, Yoshihiro Yamaguchi, and Kei Murayama. "Drag reduction on a flat-back ground vehicle with active flow control." *Journal of Wind Engineering and Industrial Aerodynamics* 145 (2015): 292-303. <https://doi.org/10.1016/j.jweia.2015.03.006>
- [18] Rouméas, Mathieu, Patrick Gilliéron, and Azeddine Kourta. "Analysis and control of the near-wake flow over a square-back geometry." *Computers & Fluids* 38, no. 1 (2009): 60-70. <https://doi.org/10.1016/j.compfluid.2008.01.009>
- [19] New, T. H., T. T. Lim, and S. C. Luo. "A flow field study of an elliptic jet in cross flow using DPIV technique." *Experiments in Fluids* 36, no. 4 (2004): 604-618. <https://doi.org/10.1007/s00348-003-0733-7>
- [20] Jahanmiri, Mohsen, and M. Abbaspour. "Experimental investigation of drag reduction on ahmed model using a combination of active flow control methods." (2011): 403-410. <https://doi.org/10.5829/idosi.ije.2011.24.04a.09>
- [21] Bruneau, Charles-Henri, Emmanuel Creuse, Delphine Depeyras, Patrick Gillieron, and Iraj Mortazavi. "Active and passive flow control around simplified ground vehicles." (2012): 89-93.
- [22] Harinaldi, Harinaldi, Budiardo Budiardo, Warjito Warjito, Engkos Achmad Kosasih, Rustan Tarakka, Sabar Pangihutan Simanungkalit, and I. Lay Teryanto. "Modification of flow structure over a van model by suction flow control to reduce aerodynamics drag." *Makara Journal of Technology* 16, no. 1 (2012): 3. <https://doi.org/10.7454/mst.v16i1.1021>
- [23] Whiteman, Jacob T., and Mei Zhuang. "Active flow control schemes for bluff body drag reduction." In *Fluids Engineering Division Summer Meeting*, vol. 50282, p. V01AT13A002. American Society of Mechanical Engineers, 2016. <https://doi.org/10.1115/FEDSM2016-7520>
- [24] Littlewood, Rob. "Novel methods of drag reduction for squareback road vehicles." PhD diss., Loughborough University, 2013.
- [25] Szodrai, Ferenc. "Quantitative analysis of drag reduction methods for blunt shaped automobiles." *Applied Sciences* 10, no. 12 (2020): 4313. <https://doi.org/10.3390/app10124313>
- [26] Barros, Diogo, Jacques Borée, Bernd R. Noack, Andreas Spohn, and Tony Ruiz. "Bluff body drag manipulation using pulsed jets and Coanda effect." *Journal of Fluid Mechanics* 805 (2016): 422-459. <https://doi.org/10.1017/jfm.2016.508>
- [27] Gilliéron, Patrick, and Azeddine Kourta. "Aerodynamic drag control by pulsed jets on simplified car geometry." *Experiments in fluids* 54, no. 2 (2013): 1-16. <https://doi.org/10.1007/s00348-013-1457-y>
- [28] Joseph, Pierric, Xavier Amandolese, and Jean-Luc Aider. "Drag reduction on the 25 slant angle Ahmed reference body using pulsed jets." *Experiments in fluids* 52, no. 5 (2012): 1169-1185. <https://doi.org/10.1007/s00348-011-1245-5>
- [29] Mukut, ANM Mominul Islam, and Mohammad Zoynal Abedin. "Review on aerodynamic drag reduction of vehicles." *International Journal of Engineering Materials and Manufacture* 4, no. 1 (2019): 1-14. <https://doi.org/10.26776/ijemm.04.01.2019.01>
- [30] Tounsi, Nabil, Rafika Mestiri, Laurent Keirsbulck, Hamid Oualli, Samir Hanchi, and Fethi Aloui. "Experimental Study of Flow Control on Bluff Body using Piezoelectric Actuators." *Journal of Applied Fluid Mechanics* 9, no. 2 (2016). <https://doi.org/10.18869/acadpub.jafm.68.225.24488>
- [31] Park, Hoonil, Jun-Ho Cho, Joonho Lee, Dong-Ho Lee, and Kyu-Hong Kim. "Aerodynamic drag reduction of Ahmed model using synthetic jet array." *SAE International Journal of Passenger Cars-Mechanical Systems* 6, no. 2013-01-0095 (2013): 1-6. <https://doi.org/10.4271/2013-01-0095>
- [32] Kourta, Azeddine, and Cédric Leclerc. "Characterization of synthetic jet actuation with application to Ahmed body wake." *Sensors and Actuators A: Physical* 192 (2013): 13-26. <https://doi.org/10.1016/j.sna.2012.12.008>
- [33] Rajapaksha, R. G. S. K., K. D. P. C. Kurukulasoorya, H. M. T. M. Herath, S. L. M. D. Rangajeeva, and R. M. P. S. Bandara. "Aerodynamic Analysis of Rear Wings and Rear Spoilers of Passenger Automobiles." *Annual Sessions of IESL*, no. October 2018 (2020): 515-22.
- [34] Saleh, Z. M., and A. H. Ali. "Numerical Investigation of Drag Reduction Techniques in a Car Model." In *IOP Conference Series: Materials Science and Engineering*, vol. 671, no. 1, p. 012160. IOP Publishing, 2020. <https://doi.org/10.1088/1757-899X/671/1/012160>
- [35] Hu, Xu-xia, and Eric TT Wong. "A numerical study on rear-spoiler of passenger vehicle." *World Academy of Science, Engineering and Technology* 57 (2011): 636-641.
- [36] Mashud, Mohammad, and Rubel Chandra Das. "Effect of rear end spoiler angle of a sedan car." In *AIP Conference Proceedings*, vol. 1851, no. 1, p. 020017. AIP Publishing LLC, 2017. <https://doi.org/10.1063/1.4984646>
- [37] [Tomar, Akhilesh Singh, Anuj Prajapati, Anuj Sharma, and Shubham Shrivastava. "CFD analysis on the aerodynamic effects of spoiler at different angle on car body." *Int. J. Innov. Technol. Explor. Eng.(IJITEE)* 8, no. 7 (2019): 2845-2848.

- [38] Fukuda, Hitoshi, Kazuo Yanagimoto, Hiroshi China, and Kunio Nakagawa. "Improvement of vehicle aerodynamics by wake control." *JSAE review* 16, no. 2 (1995): 151-155. [https://doi.org/10.1016/0389-4304\(95\)00007-T](https://doi.org/10.1016/0389-4304(95)00007-T)
- [39] Patil, C. N., K. S. Shashishekar, A. K. Balasubramanian, and S. V. Subbaramaiah. "Aerodynamic Study and drag coefficient optimization of passenger vehicle." *International Journal of Engineering Research & Technology (IJERT)* 1, no. 7 (2012): 1-8.
- [40] Marklund, Jesper, and Lennart Lofdahl. "Influence of a Diffuser to the Wake Flow of a Passenger Car." In *Fluids Engineering Division Summer Meeting*, vol. 44755, pp. 53-62. American Society of Mechanical Engineers, 2012. <https://doi.org/10.1115/FEDSM2012-72353>
- [41] Marklund, Jesper. *Under-body and diffuser flows of passenger vehicles*. Chalmers Tekniska Hogskola (Sweden), 2013.
- [42] Palaskar, Pruthviraj Mohanrao. *Effect of side taper on aerodynamics drag of a simple body shape with diffuser and without diffuser*. No. 2016-01-1621. SAE Technical Paper, 2016. <https://doi.org/10.4271/2016-01-1621>
- [43] Zuan, A. M. S., A. Ruwaidab, S. Syahrullailc, and M. N. Musad. "The Effect of Adding Diffuser by Experimental." *Journal of Advanced Research in Applied Mechanics* 14: 18-24.
- [44] Wood, Andrew, Martin Passmore, David Forbes, Daniel Wood, and Adrian Gaylard. "Base pressure and flow-field measurements on a generic SUV model." *SAE Int. J. Passeng. Cars-Mech. Syst* 8, no. 1 (2015): 233-241. <https://doi.org/10.4271/2015-01-1546>
- [45] Mohankumar, M., and H. Raj. "Investigating the Effect of Rear Spoiler and Rear Diffuser on Aerodynamic Forces using CFD." *International Journal of Engineering Research & Technology* 3, no. 26 (2015): 1-6.
- [46] Altaf, Alamaan, Ashraf A. Omar, and Waqar Asrar. "Passive drag reduction of square back road vehicles." *Journal of Wind Engineering and Industrial Aerodynamics* 134 (2014): 30-43. <https://doi.org/10.1016/j.jweia.2014.08.006>
- [47] Yuan, Cheng See, Shuhaimi Mansor, and Mohd Azman Abdullah. "Effect of spoiler angle on the aerodynamic performance of hatchback model." *Int. J. Appl. Eng. Res* 12, no. 22 (2017): 12927-12933.
- [48] Beaudoin, Jean-François, and Jean-Luc Aider. "Drag and lift reduction of a 3D bluff body using flaps." *Experiments in fluids* 44, no. 4 (2008): 491-501. <https://doi.org/10.1007/s00348-007-0392-1>
- [49] Pavia, Giancarlo, Martin Passmore, and Adrian Gaylard. *Influence of short rear end tapers on the unsteady base pressure of a simplified ground vehicle*. No. 2016-01-1590. SAE Technical Paper, 2016. <https://doi.org/10.4271/2016-01-1590>
- [50] Varney, Max, Martin Passmore, and Adrian Gaylard. "The effect of passive base ventilation on the aerodynamic drag of a generic SUV vehicle." *SAE International Journal of Passenger Cars-Mechanical Systems* 10, no. 2017-01-1548 (2017): 345-357. <https://doi.org/10.4271/2017-01-1548>
- [51] Urquhart, Magnus, Max Varney, Simone Sebben, and Martin Passmore. "Aerodynamic drag improvements on a square-back vehicle at yaw using a tapered cavity and asymmetric flaps." *International Journal of Heat and Fluid Flow* 86 (2020): 108737. <https://doi.org/10.1016/j.ijheatfluidflow.2020.108737>
- [52] Urquhart, Magnus, Max Varney, Simone Sebben, and Martin Passmore. "Drag reduction mechanisms on a generic square-back vehicle using an optimised yaw-insensitive base cavity." *Experiments in Fluids* 62, no. 12 (2021): 1-21. <https://doi.org/10.1007/s00348-021-03334-0>
- [53] Siddiqui, Naseeb Ahmed, and Martin Agelin-Chaab. "Drag Reduction on a Square Back Ahmed Body Using a Simple Flap." <https://doi.org/10.32393/csme.2021.139>
- [54] Wahba, E. M., Humaid Al-Marzooqi, Majd Shaath, Mohamed Shahin, and Tarek El-Dhmarshawy. "Aerodynamic drag reduction for ground vehicles using lateral guide vanes." *CFD letters* 4, no. 2 (2012): 68-79.
- [55] Elsayed, Omer, Ashraf A. Omar, Ali Jeddi, Saad EL HESSNI, and Fatima Zahra Hachimy. "Drag Reduction by Application of Different Shape Designs in a Sport Utility Vehicle." *International Journal of Automotive and Mechanical Engineering* 18, no. 3 (2021): 8870-8881. <https://doi.org/10.15282/ijame.18.3.2021.03.0680>
- [56] Kane, Shashank N., Ashutosh Mishra, and Anup K. Dutta. "Preface: International conference on recent trends in physics (ICRTP 2016)." In *J. Phys. Conf. Ser.*, vol. 755, no. 1, pp. 0-5. 2016. <https://doi.org/10.1088/1742-6596/755/1/011001>
- [57] Tian, Jie, Yingchao Zhang, Hui Zhu, and Hongwei Xiao. "Aerodynamic drag reduction and flow control of Ahmed body with flaps." *Advances in Mechanical Engineering* 9, no. 7 (2017): 1687814017711390. <https://doi.org/10.1177/1687814017711390>
- [58] Esa, Syamsul Azry Md, Wan Mohd Arif Aziz Japar, and Nor Azwadi Che Sidik. "Design and analysis of vortex induced vibration (viv) suppression device." *CFD Letters* 11, no. 2 (2019): 66-80.
- [59] Gámiz, Unai Fernández. "Fluid dynamic characterization of vortex generators and two-dimensional turbulent wakes." *POLYTECHNIC UNIVERSITY OF CATALONIA, CATALONIA,[Online]. Available: www. tesisenred.net/bitstream/handle/10803/13459/tufg1de1.pdf [Accessed 27 June 2015]* (2013).
- [60] Koike, Masaru, Tsunehisa Nagayoshi, and Naoki Hamamoto. "Research on aerodynamic drag reduction by vortex generators." *Mitsubishi motors technical review* 16 (2004): 11-16.



- [61] Yadav, Aanchal, Pooja Rawal, and R. K. Mishra. "Modelling and simulation of aerodynamic performance of Vortex generators for hatch back type cars." *Vibroengineering PROCEDIA* 21 (2018): 131-136. <https://doi.org/10.21595/vp.2018.20399>
- [62] Selvaraju, P. N., and K. M. Parammasivam. "Empirical and numerical analysis of aerodynamic drag on a typical SUV car model at different locations of vortex generator." *Journal of Applied Fluid Mechanics* 12, no. 5 (2019): 1487-1496. <https://doi.org/10.29252/JAFM.12.05.29674>
- [63] Zakher, Bassem Nashaat, Mostafa El-Hadary, Mohammed Abd Elfatah Elgohary, and Ibrahim M. El Fahham. "A Comparison Between Experimental Life Road Simulation and Computational Fluid Dynamics and Fluid Structure Interaction for Sedan Car." *CFD Letters* 14, no. 2 (2022): 81-97. <https://doi.org/10.37934/cfdl.14.2.8197>
- [64] Rahman, Fazalul, and Iswarya Thiyagarajan. "The Effect of Orientation of Vortex Generators on Aerodynamic Drag Reduction in Cars." *Int. Ref. J. Eng. Sci.* 4, no. 7 (2015): 13-20.
- [65] Shankar, G., G. Devaradjane, and S. Sunil. "Investigation on Aerodynamic Behaviour of a SUV Car Model with Vortex Generators at Different Yaw Conditions." *Journal of Applied Fluid Mechanics* 12, no. 1 (2019): 103-117. <https://doi.org/10.29252/jafm.75.253.28851>
- [66] Palanivendhan, M., J. Chandradass, Praveen Kumar Bannaravuri, Jennifer Philip, and Kumar Shubham. "Aerodynamic simulation of optimized vortex generators and rear spoiler for performance vehicles." *Materials Today: Proceedings* 45 (2021): 7228-7238. <https://doi.org/10.1016/j.matpr.2021.02.537>
- [67] Islam, Md Rasedul, Md Amzad Hossain, Mohammad Mashud, and Md Tanvir Ibny Gias. "Drag reduction of a car by using vortex generator." *International Journal of Scientific & Engineering Research* 4, no. 7 (2013): 1298-1302.
- [68] Pujals, Grégory, Sébastien Depardon, and Carlo Cossu. "Drag reduction of a 3D bluff body using coherent streamwise streaks." *Experiments in fluids* 49, no. 5 (2010): 1085-1094. <https://doi.org/10.1007/s00348-010-0857-5>
- [69] Sen, Wriddha, Kazi Afzalur Rahman, and Ibrahim Khalil Tanim. "Experimental and CFD Analysis on Car with Several Types of Vortex Generators." In *Proceedings of the International Conference on Mechanical Engineering and Renewable Energy*. 2019.
- [70] Vinodhini, P. Jennifer, T. J. Samuvel, and G. S. Raj. "Numerical Analysis of Drag Reduction Method Using Vortex Generator on Symmetric Aerofoil." *Coimbatore, India* (2016). <https://doi.org/10.14445/22315381/IJETT-V35P207>
- [71] Katz, Joseph, and Darwin Garcia. "Aerodynamic effects of Indy car components." *SAE Transactions* (2002): 2322-2330. <https://doi.org/10.4271/2002-01-3311>
- [72] Garcia, Darwin L., and Joseph Katz. "Trapped vortex in ground effect." *AIAA journal* 41, no. 4 (2003): 674-678. <https://doi.org/10.2514/2.1997>
- [73] Katz, Joseph, and Frederic Morey. "Aerodynamics of large-scale vortex generator in ground effect." *Journal of fluids engineering* 130, no. 7 (2008). <https://doi.org/10.1115/1.2948361>
- [74] Dandan, Muhammad Arif, Syahrullail Samion, Mohamad Nor Musa, and Fazila M. Zawawi. "Evaluation of Lift and Drag Force of Outward Dimple Cylinder Using Wind Tunnel." (2021).
- [75] Mukut, ANM Mominul Islam, Hasan Mohamamad Mostofa Afroz, Hiroshi Mizunuma, and Hiromichi Obara. "Evaluation of Double-Sided Plasma Vortex Generator in Comparison with Vane Vortex Generator on Separation Control." *International Journal of Automotive and Mechanical Engineering* 19, no. 1 (2022): 9433-9446. <https://doi.org/10.15282/ijame.19.1.2022.07.0726>
- [76] Sagar, Dheeraj, Akshoy Ranjan Paul, Ravi Ranjan Upadhyay, and Anuj Jain. "Aerodynamic effects of rear spoiler and vortex generators on passenger cars." In *Proceedings of 5th International Conference on Theoretical, Applied, Computational and Experimental Mechanics (ICTACEM-2010)*, no. 311, pp. 760-762. 2010.
- [77] Bansal, Ram, and R. B. Sharma. "Drag reduction of passenger car using add-on devices." *Journal of Aerodynamics* 2014 (2014). <https://doi.org/10.1155/2014/678518>
- [78] Datta, Basudev, Vaibhav Goel, Shivam Garg, and Inderpreet Singh. "Study of Various Passive Drag Reduction Techniques on External Vehicle Aerodynamics Performance: CFD Based Approach." *International Research Journal of Engineering and Technology (IRJET)* 6 (2019): 1851-1871.
- [79] Szodrai, Ferenc. "Quantitative analysis of drag reduction methods for blunt shaped automobiles." *Applied Sciences* 10, no. 12 (2020): 4313. <https://doi.org/10.3390/app10124313>
- [80] Sudin, Mohd Nizam, Mohd Azman Abdullah, Shamsul Anuar Shamsuddin, Faiz Redza Ramli, and Musthafah Mohd Tahir. "Review of research on vehicles aerodynamic drag reduction methods." *International Journal of Mechanical and Mechatronics Engineering* 14, no. 02 (2014): 37-47.
- [81] Zali, I. A. M., and I. S. Ishak. "Effects of Boundary Layer Scrapper on Aerodynamic Characteristics for Automotive Wind Tunnel Testing." *Journal of Transport System Engineering* 2, no. 2 (2015): 14-20.

- [82] Koto, Jaswar, Firdaus Mahamad, Iskandar Shah Ishak, and M. S. Ammoo. "Aerodynamic Characteristics for Helicopter Tail Rotor Propeller Delta Wing UAV Model View Project Sea Temperatures for OTEC View Project." *Aeronautical Engineering Research at UTM*, no. March 2017 (2016).