

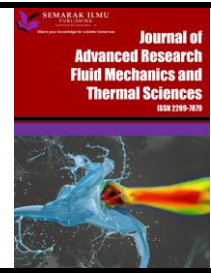

Journal of Advanced Research in Fluid Mechanics and Thermal Sciences

Journal homepage:
https://semarakilmu.com.my/journals/index.php/fluid_mechanics_thermal_sciences/index
ISSN: 2289-7879



The Comparison of P, PI and PID Strategy Performance as Temperature Controller in Active Iris Damper for Centralized Air Conditioning System

Nur'Amirah Busu¹, Norasikin Mat Isa^{1,*}, Azian Hariri¹, Mohamed Hussein²

¹ Faculty of Mechanical and Manufacturing Engineering, Universiti Tun Hussein Onn Malaysia, 86400 Parit Raja, Johor, Malaysia

² Faculty of Mechanical Engineering, Universiti Teknologi Malaysia, 81310 Skudai, Johor, Malaysia

ARTICLE INFO

Article history:

Received 30 July 2022

Received in revised form 22 December 2022

Accepted 2 January 2023

Available online 22 January 2023

Keywords:

Active iris damper; diffuser damper;
thermal comfort; temperature control;
PID controller; HVAC system

ABSTRACT

The topic of maintaining thermal comfort efficiency in the heating, ventilation and air conditioning (HVAC) sector has always been tricky due to numerous challenges. The study focused on the challenge of under-actuated zones in non – residential and commercial buildings. The active iris damper with the integration of thermal controller is proposed to control the indoor temperature. Besides, integration of PID control strategy will be a tempting control system in enhancing the thermal performance of the building. Again, the PID controller has proven good compatibility as a primary closed-loop mechanism to maintain a comfortable room temperature. The development of the control system is done through the Arduino platform with LabVIEW as the front panel and data logging platform. The Heuristic tuning method was employed to obtain optimal gains for P, PI and PID controllers. The performance of each controller was tested by observing their ability to maintain steadily at the desired temperature set point. These tests conveyed that the best controller for this application is the PID controller. It reached the desired temperature set point and maintained it even with a temperature disruption. This study indicates that an active iris damper can effectively maintain the thermal comfort performance of indoor environment with the implementation of PID strategy, thus remedying some of the problems faced by centralized air-conditioning systems.

1. Introduction

In a very hot and humid country throughout the year, such as Malaysia, there is a growing demand for better thermal comfort within building environments to cope with the ever-unpredictable weather. These will result in a significant increase in energy consumption, which can be attributed to the proliferation of heating, ventilating and air-conditioning (HVAC) system installments. According to Brooks *et al.*, [1], commercial buildings consume many energy usages, and approximately half of this consumption is from the HVAC systems implemented.

Most of the large building using the centralized air-conditioning systems with the variable-air-volume (VAV) air handling configuration. Referring to Figure 1, one VAV box will supply the cooled

* Corresponding author.

E-mail address: sikin@uthm.edu.my

<https://doi.org/10.37934/arfmts.102.2.143154>

air into a zone. Meanwhile, a zone consists of a few rooms with different cooling load requirements. In which, a room with less occupants requires less cooling load compare to the room with more occupants. Thus, the thermal comfort levels may differ unevenly by zones or floors, which can cause some areas to be too cold or too warm due to over-actuated and under-actuated airflow. Besides, an empty room also received the same amount of air supply which significantly led to wastage.

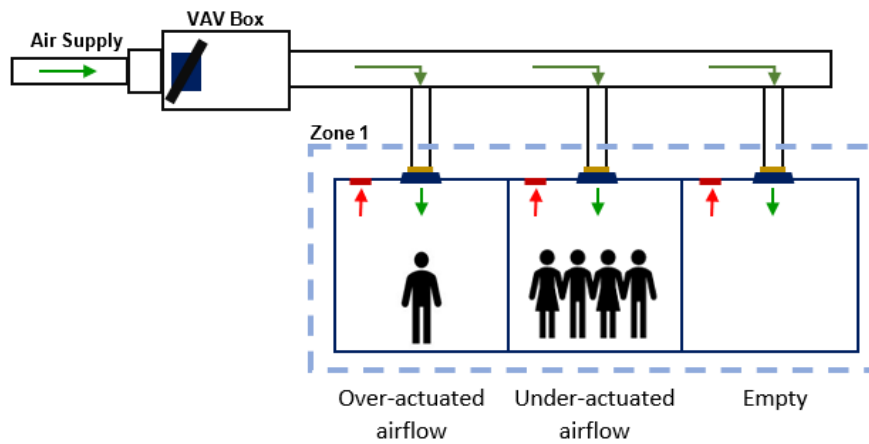

Fig. 1. The air flow distribution problems in VAV system

A lot of research has been conducted to increase the efficiency of current HVAC systems to reduce energy consumption while maintaining or improving the occupants' thermal comfort. Brooks *et al.*, [1] proposed developing an occupancy-based feedback control algorithm for variable air volume (VAV) HVAC systems to improve under-actuated zones. According to Brooks *et al.*, when multiple rooms share the same HVAC equipment, such as the same VAV system, the rooms become under-actuated since each room's climate cannot be controlled individually. Rismanchi *et al.*, [2] also stated the setpoint in VAV system always misread by sensor due to the formation of pollutant pockets which resulting the energy waste, thermal discomfort and poor air quality.

Similar to Lu *et al.*, [3], which also introduces the concept of an occupancy-based feedback control algorithm. However, they integrated a CO₂-based demand-controlled ventilation strategy. They took CO₂ measurements and used the data to estimate the occupancy of a sports training arena and subsequently control outdoor-air ventilation for energy efficiency. This implementation will ensure that the sports training area will always maintain a good level of ventilation, especially when a training session is underway.

Meanwhile, Delwati *et al.*, [4] introduced pressure reset control in the demand-controlled-ventilation to improve system performance and reduce the energy use in the ventilation system. Other than that, a state feedback control system proposed by Lachhab *et al.*, [5] in regulating the indoor temperature of building services has been able to save more than 30% of energy consumption compared to proportional-integral-derivative (PID) and On-Off control strategies. But, the indoor temperature control via variable speed drive control proposed by Nasution *et al.*, [6] in maximizing the energy-saving and performance of air conditioning system had achieved 45.72% of energy saving.

PID control strategy has gained my interest in implementing this control strategy into active iris damper which functioning as a standalone device to control the indoor temperature of specific room with centralized air conditioning system without modifying the existing HVAC system configurations. PID control strategy also has been approved as a reliable control strategy in controlling the room temperature. Shaoyong Li *et al.*, [7] used PID strategy to control the indoor temperature of each air-conditioned room with fan coil unit (FCU).

In centralized air conditioning system scope, Ibrahim Oleolo *et al.*, [8] had proposed Autoregressive-moving average with exogenous terms (ARMAX) as the best system identification approach for an operating centralized multi-circuit water-cooled package unit air-conditioning system in enhancing the energy efficiency.

Not limited in temperature controlling, Mohd Nadzri Mamat *et al.*, [9] also implement PID feedback control with modified Zeigler-Nichols tuning method in their SEPIC-Boost Converter. Besides, Chai Mau Shern *et al.*, [10] had improved the Particle Swarm Optimization (PSO) by combining the PID controller into the system for positioning control in their proposed Electro-Hydraulic Actuator (EHA) system.

Focusing on the thermal comfort performance, Papadopoulos *et al.*, [11] work on rethinking the HVAC temperature set points in commercial buildings, which had the potential for zero-cost energy savings. According to the thermal comfort studies discussed by several authors [12-15], indoor thermal comfort is achieved by maintaining the air temperature between 20°C to 27°C. But still, in Malaysia, 24°C to 25°C is the comfortable temperature range for Malaysian due to neither being too cool nor too hot climate conditions as explained by Ahmad *et al.*, [16] and Ismail *et al.*, [17].

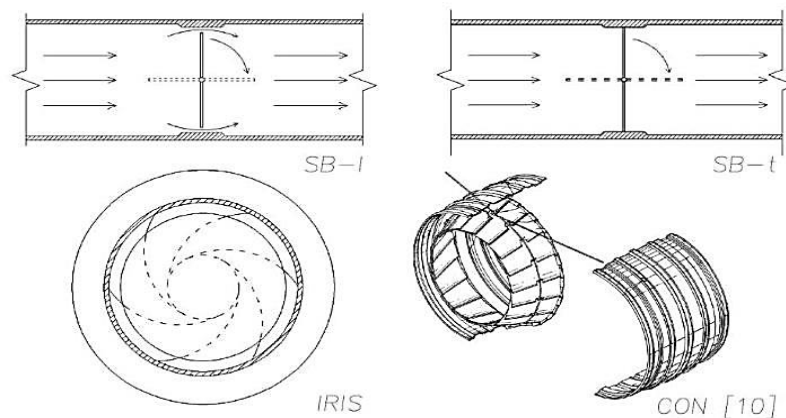

Fig. 2. Schematic drawing of dampers used by Millers *et al.*, [18]

In the HVAC study, Millers *et al.*, [18] had proposed the iris diaphragm as a circular air damper in VAV ventilation systems. They focused on comparing and measuring the control curves and characteristics of multiple damper designs, such as the single blade damper with high and low leakage, damper with iris type diaphragm and conical diaphragm damper, as shown in Figure 2. Results discovered that the iris diaphragm damper was the best among the others since it has the best control characteristics in VAV ventilation systems and has the potential for zero leakages.

The idea of combining the iris mechanism with PID control strategy will be a good integration in enhancing thermal comfort in terms of indoor temperature for commercial buildings. Instead of modifying the air damper in the VAV box, this study proposed changing the air damper which attaches to the diffuser on a centralized air-conditioning system. Figure 3 illustrates the difference between the air damper in the VAV box, also known as zone damper, and the air damper at the diffuser.

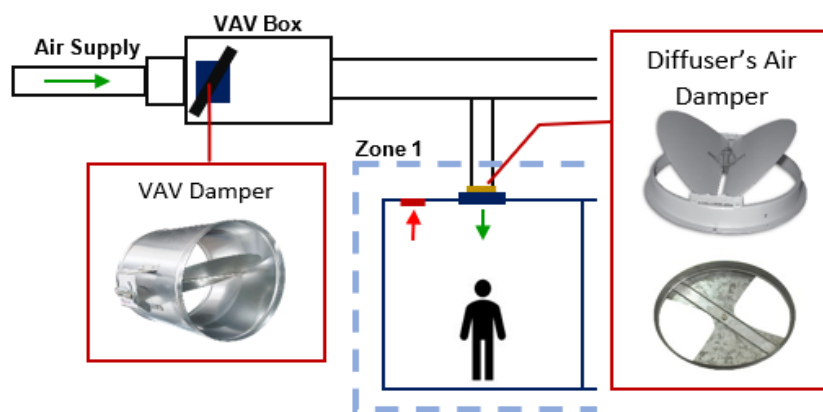

Fig. 3. Type of dampers in the ventilation system consists of zone damper (VAV damper) and diffuser's air damper

Currently, for diffuser's air dampers, only a manual adjustment type is used. No motorized damper is available for the diffuser air damper. Besides, in Malaysia, only limited air damper patterns are available in the market, such as butterfly and radial patterns. Therefore, this research would like to introduce an active iris damper with the integration of thermal controller in enhancing the thermal performance of indoor environment.

Research study aims to explore the possibility of improving the overall thermal comfort of occupants in large commercial buildings while simultaneously reducing the building's HVAC system energy consumption through the implementation of an active iris damper system into the air-conditioning diffuser. Implementing these active iris dampers enables better temperature control, reduced compressor wear, and lower energy consumption by varying the airflow velocity according to the inlet diameter of the damper opening from the vents into the room. According to Muhammad Arif Budiyanto *et al.*, [19], the greater the air velocity, the faster the cooling speed which leads to the cooler the temperature. Since the active iris damper is a standalone device, there will be no modification needed for the entire HVAC system, thus will reduce the installation and maintenance cost.

This paper will present the results of a preliminary study on the indoor temperature performance using P, PI and PID control strategy that will be integrated into the active iris damper system.

2. Preliminary Study

2.1 Overview

This research introduces the iris mechanism as an air damper pattern for the correction unit with the integration of a PID controller. The selection of iris pattern was based on the CFD simulation that had been done using Ansys FLUENT. The main idea is, the active iris damper will be attached to the diffuser to regulate the inlet air velocity from the duct. Thus, maintaining the indoor air temperature. Indirectly, improving thermal comfort in terms of indoor temperature.

The prototype of the active iris damper was 3D printed with a scaled-down ratio of 1:10 from the actual size. The pinion gear was added to let the motor to takes control of the opening and closing of the active iris damper. Thus, the of airflow velocity can be increased and decreased, respectively. Figure 4 represents the fabricated prototype of the iris damper for this preliminary study.



Fig. 4. The active air damper prototype

2.3 Experimental Test Rig

For experimental purposes, a mock-up test rig was set up using a polystyrene box and the 3D printed active air damper, as shown in Figure 5. The polystyrene box is fitted with four holes on each side to allow sufficient ventilation, similar to an actual room.



Fig. 5. The mock-up test rig set-up

Figure 6 shows an illustration of the complete set-up for the experimental analysis. Firstly, the test rig box was assembled with the iris damper and inlet duct. Cooled air with an initial temperature of 20°C was supplied into the box through the inlet duct. Then, the laptop will display the main front panel, which was developed using LabVIEW and enables the user to set the input commands like temperature set point and PID gains, respectively. The temperature set point command by the user was 24°C which aligned with the thermal comfort level established in ASHRAE.

3. Results

The experiment was conducted using a proportional (P) controller to select the best proportional value, followed by a proportional-integral (PI) controller and proportional-integral-derivative (PID) controller, respectively. There were three tests for each controller with the selected constant value for each parameter. Heuristic tuning method is used in tuning the PID gains until the best control condition is obtained.

3.1 Proportional Control Analysis

In tuning the proportional controller, the proportional gain used for Test 1 was 3, then increased to 6 and 9 for Test 2 and 3. Meanwhile, the integral and derivative gains are set to 0. From the comparison result of temperature against the time graph for Test 1, Test 2 and Test 3, Figure 8(a) shows that the ideal proportional gain was from Test 3, which is 9. It responded quickly by reaching the temperature set point after the 70s compared to 84s and 123s of Test 1 and 2, respectively, as shown in Figure 8(b).

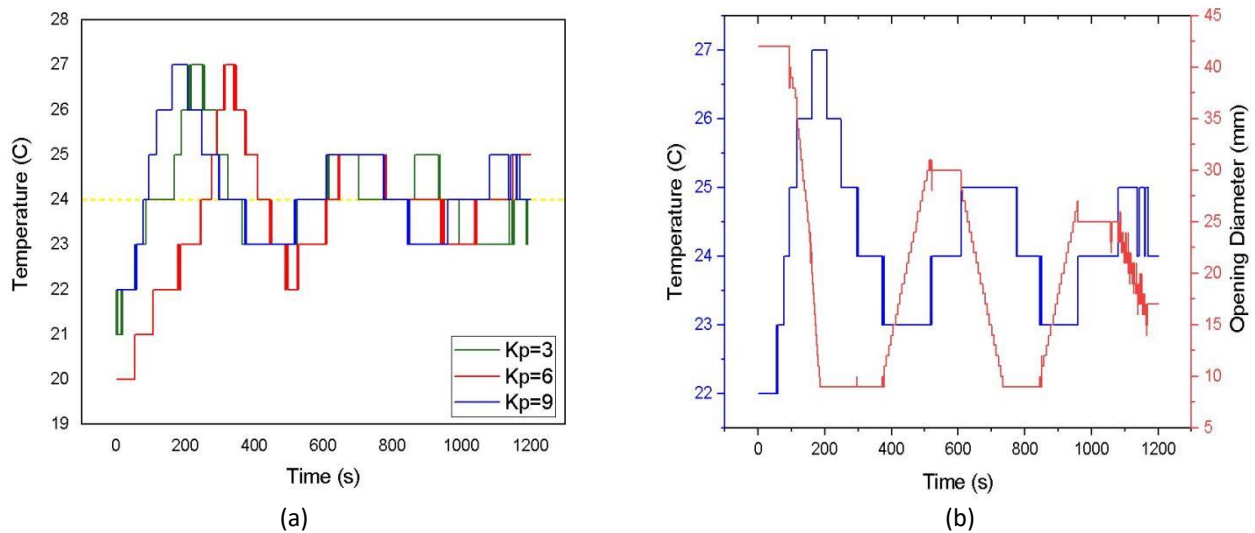

Fig. 8. (a)The comparison of real-time temperature graph for P controller and (b) Test 3 real-time graph of temperature and opening diameter relationship at $K_d=9$

However, all proportional controllers tested suffered a high overshoot of around 27°C, three degrees Celsius above the setpoint temperature. Moreover, all three tests also suffered from a steady-state offset error, where the temperature was maintained at an offset from the set point temperature a lot before oscillation. This condition occurs since the proportional controller tries to keep the measurement at a value near the setpoint. But high gain distorts the system on/off control and is unable to minimize the offset. Meanwhile, the system oscillates out of control when the proportional band is low.

3.2. Proportional-Integral Control Analysis

Once the suitable proportional gain has been determined, the aggressiveness of the proportional gain is reduced slightly before adding the integral gain. Since the proportional gain of $K_p=9$ is not too aggressive for the system, it is reduced to $K_p=8$ before carrying out the integral gain tests. In deciding

for the best integral gain for the system, the proportional gain was set to $K_p=8$, and the differential gain was set to 0. In contrast, the integral gain was increased slowly until a satisfactory value was achieved with minimal oscillation.

For Test 4, the integral gain was set at $K_i=3$, and the results showed that it managed to converge to a zero steady-state with a settling time of 1040 seconds. Test 5 was carried out with a higher integral gain of $K_i=6$, which was too high for the system. The actuator response was too high, resulting in the damper opening and close too fast. This condition led to a lot of temperature oscillations.

To overcome this condition, the integral gain was reduced to $K_i=5$ for Test 6, and the graph showed that the system managed to converge to a zero steady-state error with a settling time of 1170 seconds. Even though Test 6 improved from Test 5, it is still not as good as Test 4 since it converged slower, with more oscillations.

Thus, the integral gain of $K_i=3$ from Test 4 was the best. However, all tests from PI controllers had minimal overshoot, around one-degree Celsius above the set point. The steady-state offset error was also eliminated in all the PI controller tests. The comparison of all PI controllers can be seen in Figure 9.

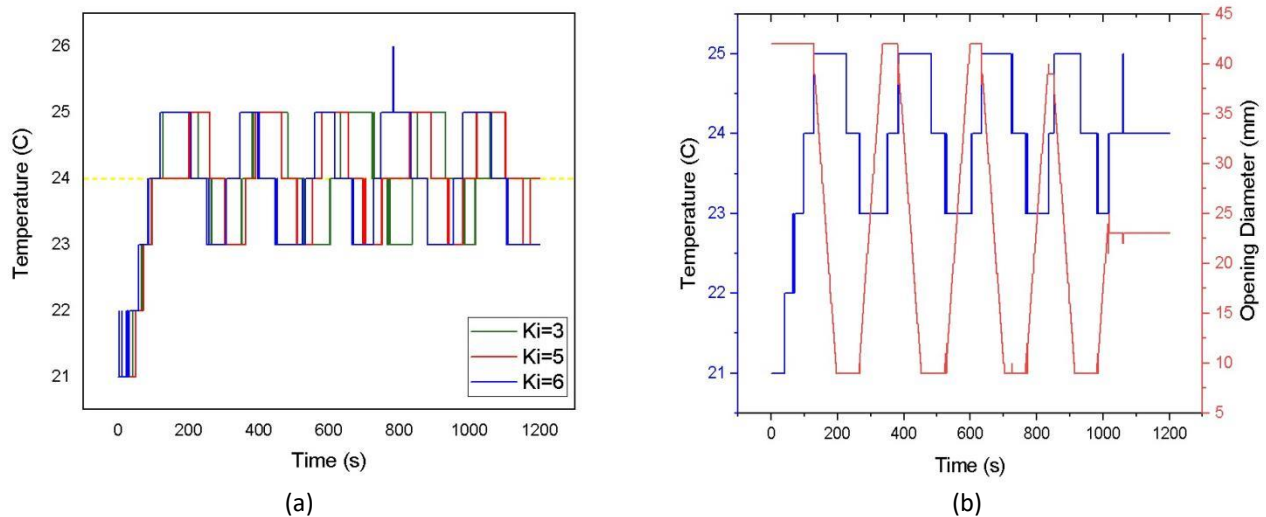

Fig. 9. (a)The comparison of real-time temperature graph for PI controller and (b) Test 4 real-time graph of temperature and opening diameter relationship at $K_i = 3$

3.3. Proportional-Integral-Derivative Control Analysis

Similar tests are made in finding the optimal point of the derivative gains, while the proportional and integral gain remains at $K_p=8$ and $K_i=3$. Test 7 started with a relatively low derivative gain of $K_d=3$. The result shows the graph could not converge and continued to oscillate. Thus, Test 7 had worse outcomes than Test 4 since it did not converge to a zero steady-state error.

Proceed with Test 8 with the derivative gain of $K_d=6$, which quickly converged to zero steady-state error with a settling time of 850 seconds. Test 8 also maintained the room temperature at the set point for the rest of the experiment after converging to zero steady-state error. At the end of the test, it can be seen that the temperature fluctuated between 24°C and 25°C. The system countered the error by adjusting the damper opening. Because of that, the system managed to prevent a steady-state offset error of 25°C.

On the other hand, Test 9, which had a derivative gain of $K_d=8$, reached a zero steady-state error faster than Test 8, with a settling time of 450 seconds. However, Test 9 did not manage to maintain the temperature set point for long. After about 4 minutes, the system becomes unstable and unable

to counter the temperature deviation. Then, it oscillated and failed to reach zero steady-state error again. This condition might be due to a derivative gain of 8, which was too high for the system, which slowed the system's response by dampening the control effect.

All the PID controllers test had an overshoot range of 1°C to 2°C above the setpoint. However, they converged on zero steady-state error faster than the PI controllers. The tests were compared, as shown in Figure 10(a), which proved that Test 8 offers the best performance. It maintained the set point temperature steadily and countered any deviation in room temperature to maintain the set point temperature by adjusting the damper accordingly, as shown in Figure 10(b).

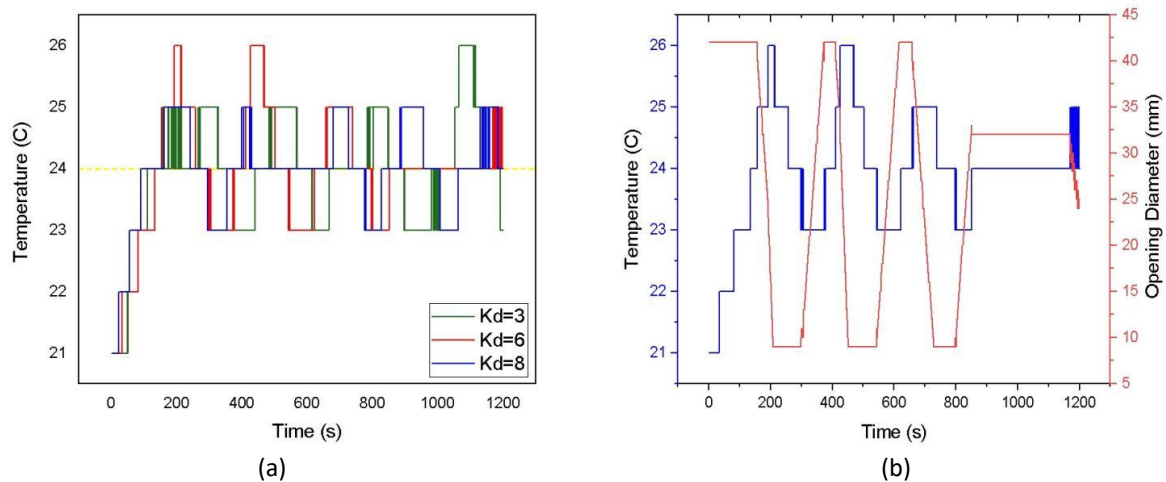

Fig. 10. (a)The comparison of real-time temperature graph for PID controller and (b) Test 8 real-time graph of temperature and opening diameter relationship at $K_d=6$

3.4. Comparison of P, PI and PID Controller

Table 1 represents the result summary of all tests. With the optimal PID tuning established, the question stands, is PID the correct control for the project? To answer that question, the best results from each controller were plotted in a single graph, as shown in Figure 11.

Table 1
 The summary result of P, PI and PID control system analysis

Test	K_p	K_i	K_d	Findings
1	3	0	0	Slow response and high overshoot.
2	6	0	0	Slow response and high overshoot.
3	9	0	0	Fast response and high overshoot.
4	8	3	0	Zero steady-state error with a settling time of 1040s.
5	8	6	0	Lots of oscillations and unstable.
6	8	5	0	Zero steady-state error with a settling time of 1170s.
7	8	3	3	Not converged to zero steady-state error.
8	8	3	6	Zero steady-state error with a settling time of 850s.
9	8	3	8	Zero steady-state error with a settling time of 450s. Unstable.

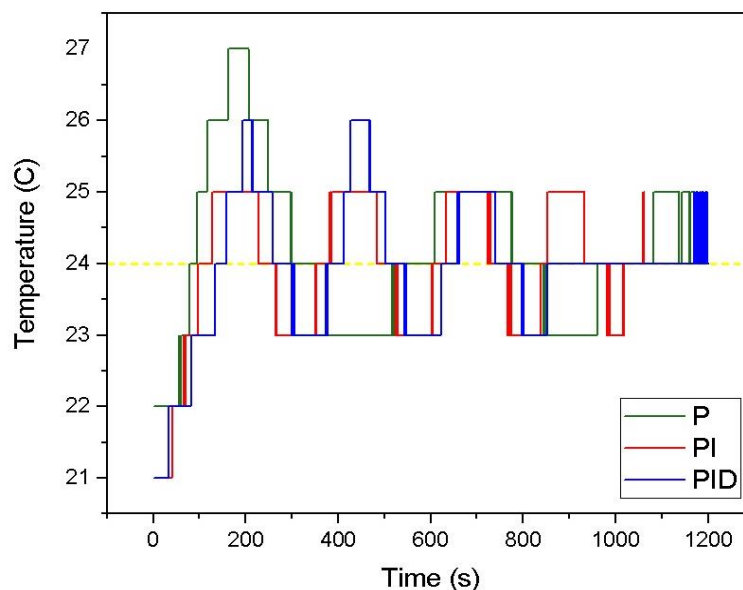

Fig. 11. The comparison graph of real time temperature for P, PI and PID controller

Test 3 represents the best P controller. Followed by Test 4, which was the best PI controller and Test 8 represented the best PID controller. When the charts are superimposed, it is clear that a proportional controller is insufficient to maintain a steady set point temperature. A proportional-integral controller does a better job than a proportional controller. It is due to the fewer oscillations and the fact that it eventually managed to maintain set point temperature. However, it is without a doubt that the PID controller is the best in this context. Test 8 and Test 9 perform well, but Test 8 shows the best performance. Besides achieving a zero steady-state error early on, the PID controllers could also maintain at the set point temperature even after any disruption in temperature occurs, as seen in Test 8.

4. Conclusions

The prototype of an active air damper was successfully fabricated and tested. In addition, the active damper control system has also been successfully developed and tuned to the optimal settings using the Heuristic method of PID tuning. The scaled-down active air damper fabricated through 3D printing could perform well and control the airflow coming into the test rig properly throughout all nine tests.

The optimal values of proportional, integral and derivative gains were obtained from the Heuristic method of PID tuning. The proportional controller achieved the best performance with the proportional gain $K_p = 9$. On the other hand, the best PI controller setting is with the gain of $K_p = 8$ and $K_i = 3$. The PID controller performed the best with the control parameter of $K_p = 8$, $K_i = 3$ and $K_d = 6$. When the three types of controllers were compared at their optimal settings, it was discovered that the PID controllers were the best performer, followed by the PI controller and the P controller. It is because the PID controller was the best at maintaining a set point temperature inside the test rig. Therefore, it was concluded that the PID controller is the most suitable type of control for the proposed active iris damper system.

Acknowledgement

The authors would like to thank Universiti Tun Hussein Onn Malaysia (UTHM) and Universiti Teknologi Malaysia (UTM) for their full support of the research work.

References

- [1] Brooks, Jonathan, Siddharth Goyal, Rahul Subramany, Yashen Lin, Chenda Liao, Timothy Middelkoop, Herbert Ingley, Laura Arpan, and Prabir Barooah. "Experimental evaluation of occupancy-based energy-efficient climate control of VAV terminal units." *Science and Technology for the Built Environment* 21, no. 4 (2015): 469-480. <https://doi.org/10.1080/23744731.2015.1023162>
- [2] Rismanchi, Behzad, Juan Mahecha Zambrano, Bryan Saxby, Ross Tuck, and Mark Stenning. "Control strategies in multi-zone air conditioning systems." *Energies* 12, no. 3 (2019): 347. <https://doi.org/10.3390/en12030347>
- [3] Lu, Tao, Xiaoshu Lü, and Martti Viljanen. "A novel and dynamic demand-controlled ventilation strategy for CO2 control and energy saving in buildings." *Energy and buildings* 43, no. 9 (2011): 2499-2508. <https://doi.org/10.1016/j.enbuild.2011.06.005>
- [4] Delwati, Muhannad, Bart Merema, Hilde Breesch, Lieve Helsen, and Maarten Sourbron. "Impact of demand controlled ventilation on system performance and energy use." *Energy and buildings* 174 (2018): 111-123. <https://doi.org/10.1016/j.enbuild.2018.06.015>
- [5] Lachhab, Fadwa, Radouane Ouladsine, Mohamed Bakhouya, and Mohamed Essaïdi. "An energy-efficient approach for controlling heating and air-conditioning systems." In *2017 international renewable and sustainable energy conference (IRSEC) IEEE*, (2017): 1-7. <https://doi.org/10.1109/IRSEC.2017.8477265>
- [6] Nasution, Henry, Afiq Aiman Dahlan, Azhar Abdul Aziz, Ulul Azmi, Sumeru Sumeru, and Sulaimon Shodiya. "Energy Efficiency of A Variable Speed of The Centralized Air Conditioning System Using PID Controller." *Jurnal Teknologi* 78, no. 8-4 (2016). <https://doi.org/10.11113/jt.v78.9586>
- [7] Li, Shaoyong, Mingsong Wei, Yeru Wei, Zongli Wu, Xilian Han, and Rongxia Yang. "A fractional order PID controller using MACOA for indoor temperature in air-conditioning room." *Journal of Building Engineering* 44 (2021): 103295. <https://doi.org/10.1016/j.jobe.2021.103295>
- [8] Oleolo, Ibrahim, Hayati Abdullah, Maziah Mohamad, Mohammad Nazri Mohd Jaafar, and Akmal Baharain. "Model Selection for the Control of Temperature in a Centralized Air Conditioning System." *Journal of Advanced Research in Applied Mechanics* 74, no. 1 (2020): 10-20.
- [9] Mamat, Mohd Nadzri, and Dahaman Ishak. "Analysis of SEPIC-Boost Converter Using Several PID Feedback Tuning Methods for Renewable Energy Applications." *Journal of Advanced Research in Applied Sciences and Engineering Technology* 26, no. 1 (2022): 105-117. <https://doi.org/10.37934/araset.26.1.105117>
- [10] Shern, Chai Mau, Rozaimi Ghazali, Chong Shin Horng, Chong Chee Soon, Jingwei Too, and Yahaya Md Sam. "Performance Evaluation of EHA System using Weight Aggregation Strategy in MOPSO-PID." *Journal of Advanced Research in Applied Mechanics* 73, no. 1 (2020): 1-10. <https://doi.org/10.37934/aram.73.1.110>
- [11] Papadopoulos, Sokratis, Constantine E. Kontokosta, Alex Vlachokostas, and Elie Azar. "Rethinking HVAC temperature setpoints in commercial buildings: The potential for zero-cost energy savings and comfort improvement in different climates." *Building and Environment* 155 (2019): 350-359. <https://doi.org/10.1016/j.buildenv.2019.03.062>
- [12] Jindal, Aradhana. "Thermal comfort study in naturally ventilated school classrooms in composite climate of India." *Building and Environment* 142 (2018): 34-46. <https://doi.org/10.1016/j.buildenv.2018.05.051>
- [13] Lu, Shilei, Bo Pang, Yunfang Qi, and Kun Fang. "Field study of thermal comfort in non-air-conditioned buildings in a tropical island climate." *Applied Ergonomics* 66 (2018): 89-97. <https://doi.org/10.1016/j.apergo.2017.08.008>
- [14] Song, Yangrui, Yuexia Sun, Shugang Luo, Jing Hou, Jungsoo Kim, Thomas Parkinson, and Richard de Dear. "Indoor environment and adaptive thermal comfort models in residential buildings in Tianjin, China." *Procedia Engineering* 205 (2017): 1627-1634. <https://doi.org/10.1016/j.proeng.2017.10.310>
- [15] Zhang, Hui, Edward Arens, Sahar Abbaszadeh Fard, Charlie Huizenga, Gwelen Paliaga, Gail Brager, and Leah Zagreus. "Air movement preferences observed in office buildings." *International journal of Biometeorology* 51, no. 5 (2007): 349-360. <https://doi.org/10.1007/s00484-006-0079-y>
- [16] Ahmad, Aidil Sukri, SA Abdul Shukor, Karl Kohlhof, Zul Azhar Zahid Jamal, and Azizul Mohamad. "Analyzing and evaluating a PMV-based thermal comfort model in controlling air conditioning system." *Jurnal Teknologi* 77, no. 28 (2015). <https://doi.org/10.11113/jt.v77.6801>
- [17] Ismail, Ahmad Rasdan, Shashi Kumar SA Karagaratnan, Rozli Zulkifli, Baba Md Deros, and Mohd Nizam Abdul Rahman. "A review on thermal comfort assessment in Malaysian industries." *Jurnal Teknologi* 59, no. 2 (2012). <https://doi.org/10.11113/jt.v59.1597>

- [18] Millers, Renars, and Uldis Pelite. "Survey of control characteristics of circular air dampers in variable air volume ventilation systems." *Energy Procedia* 96 (2016): 294-300. <https://doi.org/10.1016/j.egypro.2016.09.152>
- [19] Budiyanto, Muhammad Arif. "Effect of Variation Inlet Velocity to the Cooling Speed Capacity Inside a Refrigerated Container." *Journal of Advanced Research in Numerical Heat Transfer* 2, no. 1 (2020): 14-20.