



CFD Investigation on Thermal Comfort in Open Spaces Library in Tropical Climate

Djabir Abdoulaye Djabir¹, Mohamad Nur Hidayat Mat², Azian Hariri^{1,*}

¹ Faculty of Mechanical and Manufacturing Engineering, Universiti Tun Hussein Onn Malaysia, Malaysia

² Faculty of Mechanical Engineering, Universiti Teknologi Malaysia, 81310 UTM Johor Bahru, Malaysia

ARTICLE INFO

Article history:

Received 16 December 2022

Received in revised form 15 January 2023

Accepted 13 February 2023

Available online 1 September 2023

Keywords:

Indoor Open Space; Thermal Comfort;
Numerical CFD; Predicted Mean Vote;
Thermal Sensation

ABSTRACT

Libraries consist of large indoor open spaces with comfortable environments for studying activities. Hence, library occupants are exposed to microclimatic conditions in the indoor environment of the library. This problem can lead to a series of thermal condition symptoms (cold or hot) and general discomfort. Therefore, this study aimed to develop computational fluid dynamic (CFD) model and validated the model with the field measurement data of the indoor open space located at the second floor of Universiti Tun Hussein Onn Malaysia (UTHM) library. Parameters validated inside the indoor open space library were air temperature, relative humidity, and mean radiant temperature measured at eight sampling points located 0.5 m height from the floor for first and second days (morning and afternoon session). Predicted Mean Vote (PMV) values and Thermal Sensation Vote (TSV) values were also validated. Then, the developed model was used to get the average comfort temperature that satisfied the PMV and TSV value between +0.5 and -0.5. The results showed that the relative errors between simulation and field measurement were less than 5.5% for air temperature, relative humidity, and mean radiant temperature. The relative error for PMV and TSV value between simulation and field measurement were less than 12.2% and 2.7% respectively. The experiment and the simulation value for all parameters investigated were in good agreement with acceptable relative error value. The study concluded that the average value of comfort temperature and relative humidity for thermal comfort value of PMV and TSV in the investigated open spaces in the library were 24°C and 57% respectively.

1. Introduction

The library building is the favorite place for students because of the suitable environment for studying activities and all the references are kept systematically [1]. Conducive library condition helps to enhance the occupants' studying activities and productivity [2]. The library is also a place where students can conduct variety of academic activities [3]. Thermal comfort, particularly inside the indoor open space library is essential to occupants, to ensure adequate distribution of comfort. temperature to occupants when performing their activities [4]. Library buildings have a unique

* Corresponding author.

E-mail address: azian@uthm.edu.my (Azian Hariri)

specification compared to the other types of buildings. The nature of library building design is usually large in size and occupied mostly throughout the daytime and can accommodate many occupants at one time. This results in crowded enclosed areas causing thermal discomfort even though the climatic conditions may be favorable [5]. In general, thermal comfort has a direct impact on occupant daily performance, health, and level of satisfaction [6]. Thus, there is the need to conduct the research study on the suitable thermal comfort temperature for library especially in tropical climate such as in Malaysia due to high temperatures and significant amounts of relative humidity [7]. Air temperature and relative humidity are the related environmental factors that affect indoor thermal comfort. Warmer air can hold more water vapor. If the water vapor content stays the same and the temperature drops, the relative humidity increases [8]. Conversely, if the water vapor content stays the same and the temperature rises, the relative humidity decreases.

The American Society of Heating, Refrigerating, and Air-Conditioning Engineers (ASHRAE) defined thermal comfort as “that condition of mind that expresses satisfaction with the thermal environment” [9]. Although some detailed thermal comfort prescriptions such as ASHRAE Standard 55 and ISO 7730 have been established for indoor environments, no prescriptions have yet been established regarding thermal comfort of indoor open spaces [10]. ASHRAE Standard 55 and ISO 7730 are the recognizable standards for thermal comfort condition. Predicted Mean Vote (PMV) is measured within the seven scale from -3 to +3 [11]. Generally, the PMV defined to be between -0.5 and +0.5 and Predicted Percentage of Dissatisfied (PDD) recommended to be below 10% in most of the time to have a comfortable condition. The standard ISO 7730 defines the comfort range which is an indoor environment with a suitable environment quality with a Predicted Percentage of Dissatisfied (PDD) equal or below 6% [12]. The human body temperature is 37°C regardless of the prevailing ambient condition. In order for the human body to be able to be in a state of thermal equilibrium with its environment, human body need to lose heat produced at the same rate as it gains heat. Furthermore, air movement is essential for body comfort as it enhances heat transfer between air and the human body and accelerates the cooling of the human body [13]. Several studies on thermal comfort was carried out in Malaysia, Singapore, Pakistan and Thailand showed that to achieve good thermal comfort, air temperature has to be from 23.8°C to 28.6°C, the airflow velocity from 0.3 m/s to 1.0 m/s and relative humidity from 30% to 60% and other studies found that the most suitable airflow velocity is in the range of 0.5 to 1.0 m/s, the relative humidity from 35% to 70% and air temperature can range from 25°C to 28°C [14]. Therefore, this study was aimed to develop and validate a CFD model for open spaces in library building for thermal comfort analysis and to investigate the thermal comfort contour plot at 0.5 from the floor.

2. Methodology

2.1 Location

The study was conducted in the UTHM library which is the largest library building in the South-East Asia region. In addition, the building is located at 151°23.61 N and 103°5'68.68" E and is nearly 25 kilometers apart from Batu Pahat town. The building contains five stories, a cylindrical shape with a circular courtyard. The first level of the building is designed for a variety of activities. The library could accommodate around 3000 users at the same time. The total diameter is 36m with a total courtyard of 13% out of 804m². The investigated indoor open space area was in level two. Figure 1 shows (a) outside view of the UTHM library building, (b) indoor open space reading area level two (c) indoor open space seminar area level two and (d) Indoor open space resting area level two close to the stairs.

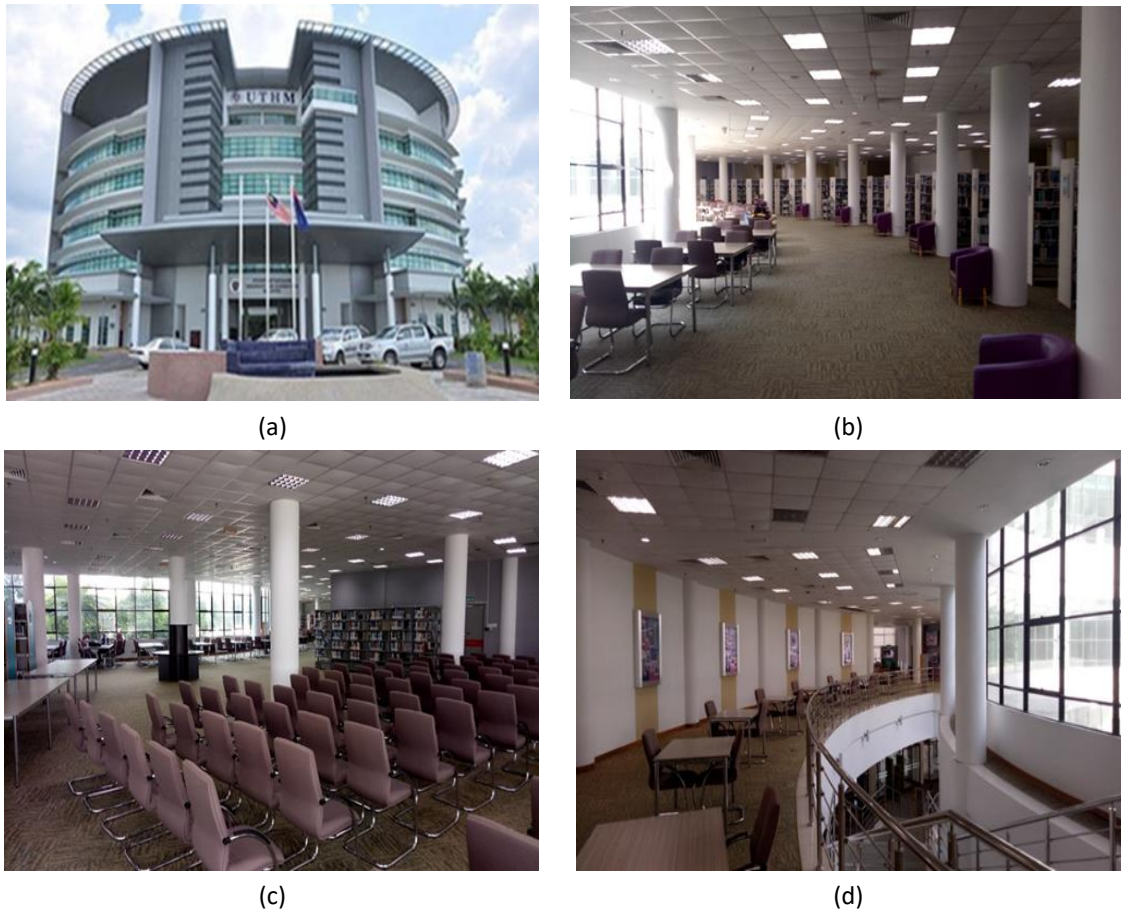

Fig. 1. (a) UTHM library building (outside view) (b) Indoor open space reading area level two (c) Indoor open space seminar area level two (d) Indoor open space resting area level two close to the stairs

2.2 Computational Fluid Dynamic Modeling

This research utilizes CFD scSTREAM student package to conduct the CFD simulations for thermal comfort condition of the UTHM library indoor open space. The simulation model was developed based on physical measurement conducted by Djabir et. al. (2022) [15]. There were eight sampling points measured 0.5m from the floor, and the data was collected in the morning and afternoon session (9 am to 12 pm and 2 to 4 pm). The model validation was conducted based on experiment measurement, the weather was hot and humid from April 4 to April 9, 2020. Two days was selected (day 1 and day 2) out of 6 days' of field measurement that was conducted.

2.3 Numerical Methodology

The use of numerical methods helped substantially in terms of understanding the thermal comfort condition in the different parts of the investigated open spaces. The analysis conducted uses the essential variable method involving the solution of set equation that described the conservation of heat mass and momentum using Navier Stokes equation and the standard k-ε turbulence model. The Reynolds-Averaged Navier-Stokes (RANS) equations for mass, momentum conservation, energy equation for conservation of mass or continuity equation started from Eq. (1)

$$\frac{\partial \rho}{\partial t} + \nabla(\rho \vec{u}) = 0 \quad (1)$$

where "p" present the static pressure which is formulated as the speed of the fluid. Transport of momentum, reference frame described in Eq. (2).

$$\frac{\partial}{\partial \tau} (\rho(\rho\vec{u}) + \nabla(\rho\vec{u}\vec{u})) = -\nabla p + \nabla(\vec{\tau}) + \rho\vec{g} + \vec{F} \quad (2)$$

where (τ) is refer to stress tensor, which is presented as gravitational body force, $F \rightarrow$ present the source terms that may arise from resistances sources. Moreover, the energy equation concerning a fluid region can be written as shown in Eq. (3).

$$\frac{\partial}{\partial \tau} (\rho h) + \nabla(\rho h\vec{u}) = \nabla[(k + k_\tau)\nabla T] + S_h \quad (3)$$

Where k is the molecular conductivity, τ is the conductivity due to turbulent transport and S_h is the source term which includes the defined volumetric heat sources. The conservation equation of species which is readily seen to be identical with the corresponding relation in the kinetic it can be written in a form that explicitly recognizes transport by convection at the mass average velocity and by diffusive transport relative to the average velocity as identified in the Eq. (4).

$$\frac{\partial}{\partial \tau} (\rho Y_i) + \nabla(\rho\vec{u} Y_i) = -\nabla \cdot \vec{J}_i + S_i \quad (4)$$

Where $Y(i)$ referred to the local mass fraction of each species, S_i is the rate of creation of addition from user defined sources. The standard k- ϵ model is a semi empirical model based on model transport equations for the turbulence kinetic energy, k, and its dissipation rate, ϵ . It is considering the simplest complete model of turbulence with two partial differential equations in which the solution of two separate transport equation. The use of the standard k- ϵ transport model which is usually used for incompressible flow, and it can define the turbulence kinetic energy and flow dissipation rate within the mode [16]. Therefore, the use of the standard k- ϵ transport model on building configuration was implemented precisely. This equation turbulence of k- ϵ types derived by Renormalization Group (RNG) methods this due to substantial prediction than the standard k- ϵ model for turbulence model separated flow. The improvements obtained from the RNG k- ϵ model were attributed to the better treatment of near wall turbulence effects. The turbulence kinetic energy and its rate of dissipation were obtained from the following transport Eq. (5) and Eq. (6).

$$\frac{\partial}{\partial \tau} (\rho k) + \frac{\partial}{\partial x_i} (\rho k u_i) = \frac{\partial}{\partial x} \left[\left(\mu + \frac{\mu_t}{\sigma_k} \right) \frac{\partial k}{\partial x_i} \right] + G_b + G_b - \rho \epsilon \quad (5)$$

$$\frac{\partial}{\partial \tau} (\rho \epsilon) + \frac{\partial}{\partial x_i} (\rho \epsilon u_i) = \frac{\partial}{\partial x} \left[\left(\mu + \frac{\mu_t}{\sigma_\epsilon} \right) \frac{\partial \epsilon}{\partial x_i} \right] + C_k 1_\epsilon \frac{\epsilon}{K} (G_k + C_{\epsilon 3} G_b) - C_{2\epsilon} \rho \frac{\epsilon^2}{K} \quad (6)$$

Where G_k refers to the generation of turbulence kinetic energy due to the mean velocity gradients. Where σ/σ_k and σ' are the turbulent numbers for computing time.

2.3.1 Boundary conditions

Boundary conditions need to be set up according to the real geometrical view of the building [17]. Hence. The locations of the air-conditioning inlets and outlet return air (diffuser) were identified. The shape of the library is circular. The total plan area of the building is 8091m² with an inner diameter of 101.5 m² of and height of 24 m of height with 6 m height for each floor. Hence, the size of the

flow inlet and outlet was 75cm x 75cm with a flowrate of 164 l/s. The ambient temperature was 23.71°C. The flux 2 natural inflow/ outflow temperature was 26°C. Flux 1 inflow temperature was set to 18°C. The flow is turbulent flow with a x direction, y direction and z direction. The domain selected for this study was incompressible flow. Thus, the diffusion coefficient for humidity water vapor ranged from 2.56 to 0.50 m/s. The modelled indoor open space was occupied by occupant’s activities in sitting mode. The wall architectural material, with a transmittance of 0.1 and absorption of 0.45. The carpet attribute conditions are solid, with a material identified to be wool with a 300K. Thus, the RNG k-ε turbulence model was applied to model air turbulence which examined indoor air flow under different turbulence models and concluded that the RNG k-ε model was the most accurate model in terms of flow separation, streamline curvature, and flow stagnation [18]. In this study the stated boundary conditions situated in the form of isometric views of domain and zoom view of diffuser as presented in Figure 2. In this study the boundary conditions were specified and listed as shown in Table 1. For example:

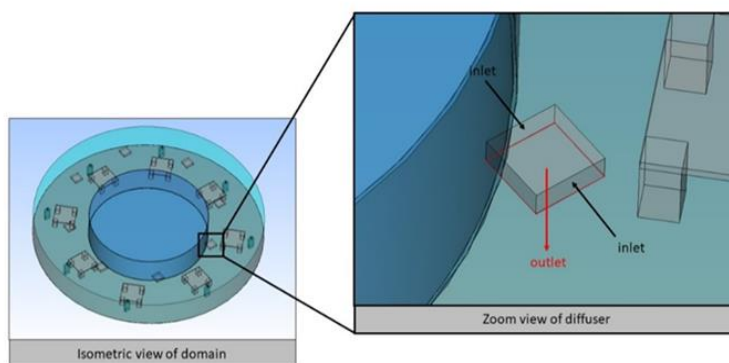

Fig. 2. Simplified CFD geometry of UTHM library indoor open space

Table 1
 Indoor open space boundary condition set-up

Item Analysis Types	Conditions
Fluid Region	
Incompressible/ Compressible	Incompressible
Flow field	turbulent flow
Steady analysis/ Transient Analysis	Transient analysis
Acceleration due to gravity	(0,0,-1) 9.8 (m/s ²)
Ambient temperature	23.71C
Humidity	
Diffusion coefficient	2.56- 0.5 (m ² s)
Unit of humidity (Input)	Relative humidity
Evaporation	Consider
Pressure	0 Pa
Flowrate	164 l/s
Domain	cuboid shape
Mannequin	Fluid

2.3.2 Indoor open space geometry

The indoor environment of the library referred to fluid region. The numerical flow analysis was meshed using fine elements. the computational domain for the CFD flow discretized finite volume method analysis. In addition, meshing is a very effective method that can make a substantial reduction on computational time during CFD flow analyses [19]. Hence, there is more benefit behind the mesh generation which is to discretize the governing equations by finding a solution to every element throughout the computational domain [20]. Fine elements were constructed all over the computational fluid domain of the indoor open space as shown in Figure 3.

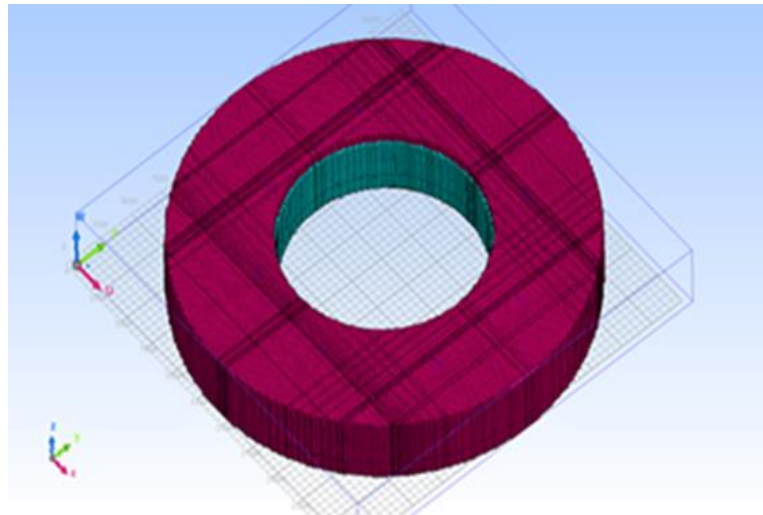

Fig. 3. Indoor open space geometry mesh of UTHM library

2.3.3 Geometry model validation

The grid independent study of the indoor open space air temperature was carried out to validate the CFD configuration model. One mesh has been selected, the fine mesh which was 0.07m respectively. The fine mesh was created using unstructured elements. The refinement ratio, γ for a 3D mesh is defined as the ratio between the number of grid elements in the fine. In addition, to get a better accuracy of the CFD configurations which can be through conditions and the generated mesh quality. Fine and coarse meshes can be identified using the Eq. (7) below. The grid refinement ratio shall be bigger than 1.3, that can help the discretization error to be apart from the other sources of error [21].

$$\gamma = (\Delta \text{ fine}) / (\Delta \text{ coarse}) \quad (7)$$

2.3.4 Grid convergence index configuration

The CFD implements discretization methods and techniques on dealing with fundamental and key transport phenomena, convection (transport due to fluid flow), including diffusion. This index referred to recorded error values and to ensure how distance from the computational aspect deviates from their respective asymptotic values. In many cases, the GCI values of less than 5% can be considered as satisfactory [22]. In addition to transport mechanism due to differences in flow motions from one point to another. In addition, the rate of changes with respect to time variations. The matrix relative error index implied to validate the CFD relative error [23]. In addition, a reduction in residuals by three orders magnitude indicates at least a qualitative convergence. At this level an

initial flow should have been created. The X component of velocity was $1.967350e-09$, Y component of velocity was $1.057050e-09$, Z component of velocity was $8.432450e-10$, pressure was $9.240320e-05$ and temperature the convergence was $1.524000e-05$, and turbulent kinetic energy was $2.023950e-09$, turbulent dissipation rate was $2.543470e-09$ and humidity was $1.234330e-10$ as shown in Figure 4.

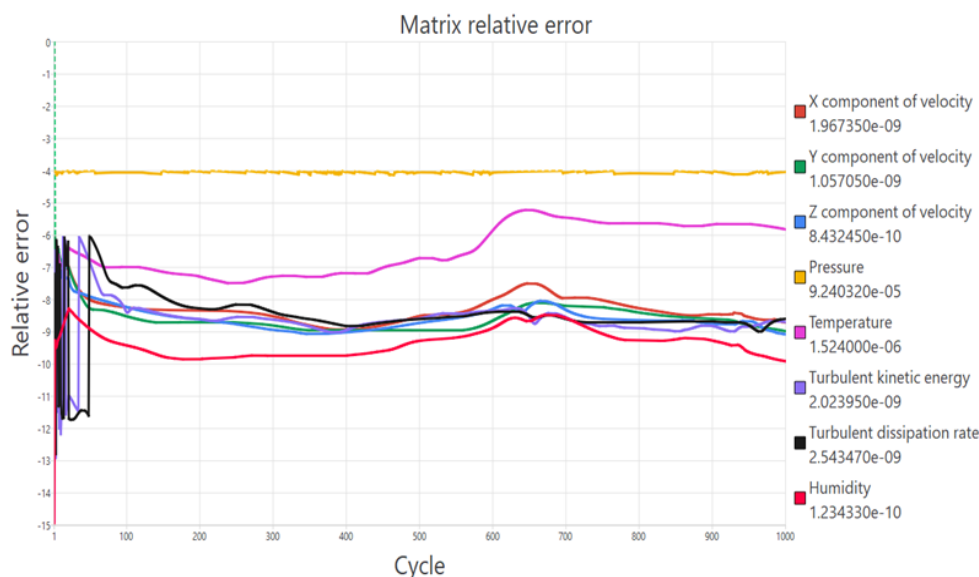

Fig. 4. Convergence plot of matrix relative error technique

2.3.5 Model validation process

Model validation requires a clear comparison with field measurement variables [24]. Therefore, the CFD data were compared to the discrete value obtained from the field measurement. The primary step of the validation approach based on data collection and simulations started with day one morning session as shown in Table 2. The comparison of air temperature value was 23.81°C for field measurement, and 23.68°C for simulations, with a relative error considered to be 0.55%, there was no huge difference between measured and simulated air temperature. The relative humidity value was 83.78% for field measurement, and 82.41% for simulation, with -1.66% of relative error. The validation criteria of mean radiant temperature in the field measurement were 24.71°C , and 23.83°C for the simulation with -3.69% of relative error. Hence, the PMV in field measurement was 0.74, and simulation was 0.77 with a minimum relative error of 3.90%. Table 3 indicated the validation of field measurement of day one afternoon session. The air temperature in field measurement was identified to be 23.45°C , and 23.32°C for simulation with a relative error -0.56%. The relative humidity recorded to be 73.85% for field measurement versus 73.59% for simulation with a minimum error of -0.35%. The mean radiant temperature of 24.18°C for field measurement and 23.87°C for simulation and -1.30% recorded relative error. The PMV was 0.40 for field measurement, and 0.45 for simulation with -11.11% of relative error. Table 4. elaborated the validation process for day 2 morning session, the air temperature was 24.00°C in field measurement and 24.47°C for simulation with 1.92% relative error. The relative humidity was 72.69% in field measurement and 70% for simulation with a relative error of -3.84%. The mean radian temperature at 24.15°C for field measurement, and 24.00°C for simulation with relative error of -0.62%. Thus, the PMV measured to be 0.46 in field measurement and 0.41 for simulation with 12.20% of relative error. Hence, in Table 5, the validation process in the day two afternoon session found that, air temperature in the field

was 23.66°C compared with 23.40°C in the simulation, with a relative error of -1.11% and relative humidity of 67.73% for field measurement result, and 71.42% in the simulation with 5.17% of relative error. The mean radiant temperature was 23.63°C in the field measurement and 23.75°C for simulation and -0.51% of relative error. The PMV was -0.61 for field measurement, and 0.55 for simulation with 10.91% of relative error. However, despite the sessional validation of field measurements versus simulation for the environmental parameters, there is strong agreement between the measured and simulated variables. The difference between the measured and simulated value was not exceedingly high.

Table 2
 Comparison and relative error for day 1 (morning session)

Day 1 (4 April) - Morning			
Variable	Field measurement	Simulation	Relative error
Air temperature	23.81	23.68	0.55 %
Relative humidity	83.78	82.41	-1.66 %
Mean Radiant Temperature	24.71	23.83	-3.69 %
PMV	0.74	0.77	3.90 %

Table 3
 Comparison and relative error for day 1 (afternoon session)

Day 1 (4 April) - Afternoon			
Variable	Field measurement	Simulation	Relative error
Air temperature	23.45	23.32	-0.56%
Relative humidity	73.85	73.59	-0.35%
Mean Radiant Temperature	24.18	23.87	-1.30%
PMV	0.40	0.45	-11.11%

Table 4
 Comparison and relative error for day 2 (morning session)

Day 2 (5 April) - Morning			
Variable	Field measurement	Simulation	Relative error
Air temperature	24.00	24.47	1.92 %
Relative humidity	72.69	70.00	-3.84%
Mean Radiant Temperature	24.15	24.00	-0.62%
PMV	0.46	0.41	12.20%

Table 5
 Comparison and relative error for day 2 (afternoon session)

Day 2 (5 April) - Afternoon			
Variable	Field measurement	Simulation	Relative error
Air temperature	23.66	23.40	-1.11%
Relative humidity	67.73	71.42	5.17 %
Mean Radiant Temperature	23.63	23.75	-0.51%
PMV	-0.61	0.55	10.91%

Figure 5 displays the PMV contour plot of day one morning session at 0.5 m height. The PMV-index is used for predicting the mean value of the subjective ratings of a group of people in each environment. Fanger, suggests this scale according to the ASHRAE thermal station scale (ASHRAE Standard -55 2013) [25]. The PMV values were determined based on the average values of the environmental parameters. The important of PMV is to determine whether a given thermal environment complies with comfort criteria of thermal neutrality and to establish requirements for different levels of acceptability. Therefore, the overall indoor open space air temperature was

23.81°C, the main radiant temperature is 23.83°C, with relative humidity of 82.41%. The PMV identified to be (0.13,0.18,0.29,0.44,0.40,0.29,0.44,0.60). from the model configuration. It can be observed that the area located near the airflow diffuser recorded less PMV compared with the area near the outlet and also location near to windows and walls. It was due to external radiation which generated from heat gain throughout the day. The PMV values of simulated data were beyond the range recommended by ASHRAE- 55 which is $-0.5 < PMV < +0.5$. These findings indicate that the indoor open space comfort temperature was a little bit thermally uncomfortable as shown in the contour plot, the PMV values are beyond the ASHRAE-55 standard

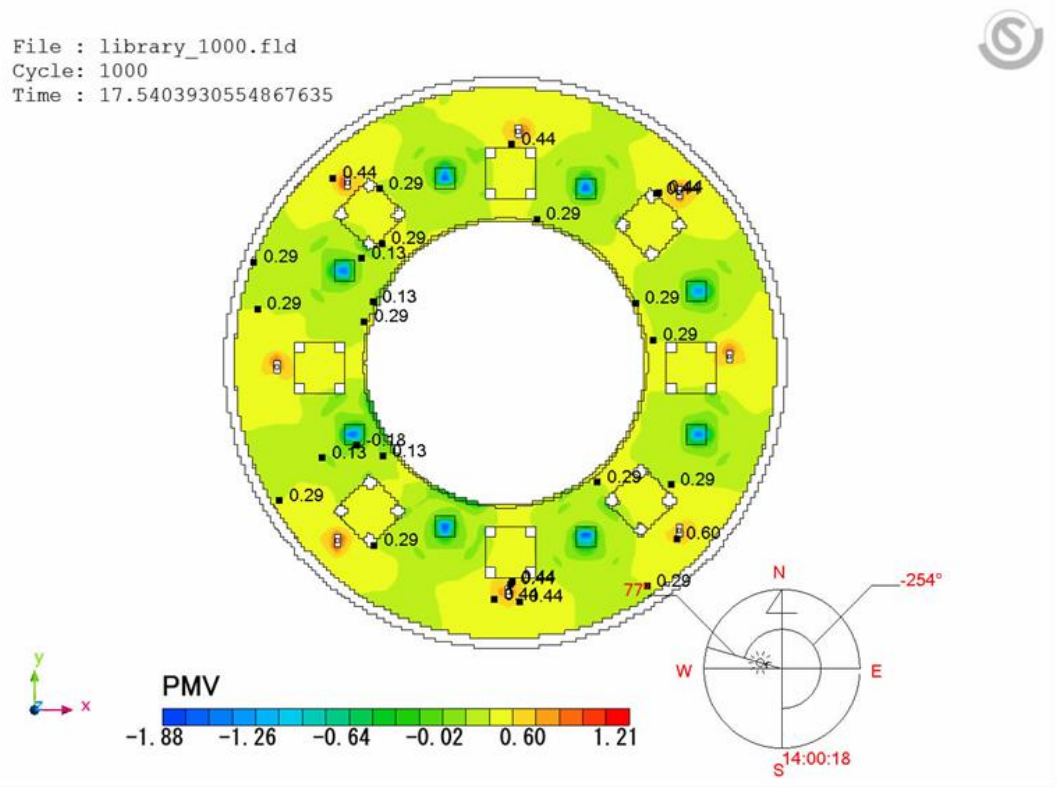

Fig. 5. PMV contour plot of day one morning session at 0.5 m height

Figure 6 presents the PMV contour plot of day one afternoon session at 0.5 m height. The air temperature is 23.32°C, with a relative humidity of 73.59 % and the mean radiant temperature is 23.87 °C. It can be observed that the recorded PMV near the diffuser was less from the area close to outlet in the point one the PMV is far less with -0.02 value compared with the point that located near the outlet location. This can be attributed to the significant flow of air supplied by the diffuser. This will in turn lower the air temperature and eventually can make a substantial reduction on PMV values. Hence more air flow to cooling effect. However, in case of high airflow generated from diffuser this may cause discomfort sensation. Hence, in the case of the indoor open space the air velocity within the recommended standards which not more than 0.2 m/s. The corresponding contour plots of the PMV values throughout the eight points were range from (-0.02,-0.03,0.29,0.44,0.60,0.29,0.60,0.44). The recommended ASHARAE 55 comfort range needs to be within -0.5 and +0.5 [26]. Beside on the point number 5 and 7, the PMV configuration contour of day one afternoon session the results were slightly over the range specified by ASHRAE- 55.



File : library_1000.fld
Cycle: 1000
Time : 17.5403930554867635

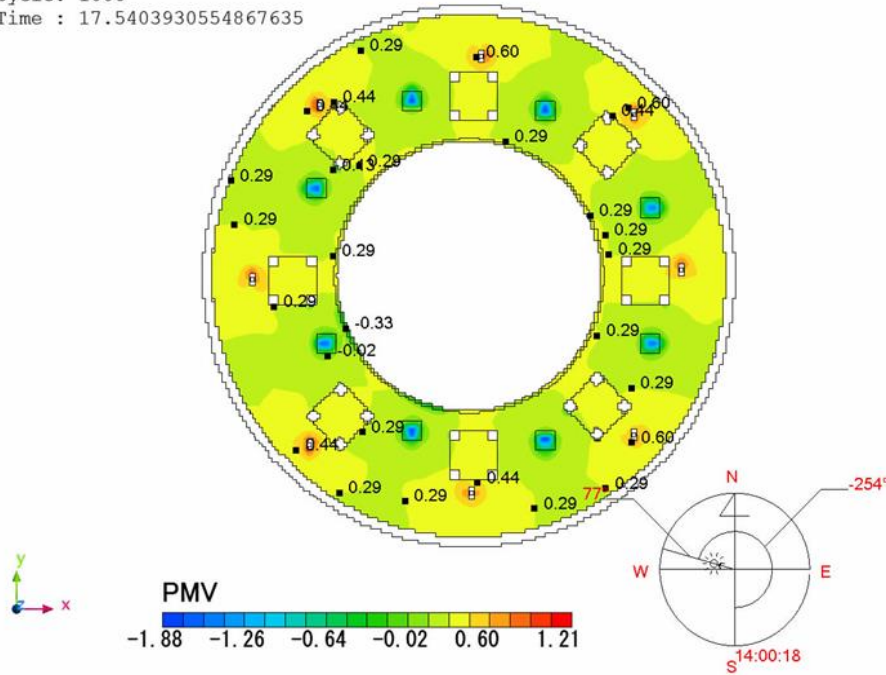

Fig. 6. PMV contour plot of day one afternoon session at 0.5 m height

Figure 7 shows the PMV configuration plot of day two morning session at 0.5 m height. The air indoor open space air temperature is 24.47°C with relative humidity of 70 % and mean radiant temperature of 24 °C. From the contour plot the minimum PMV value was -0.03 near the source of airflow for the inlet versus 0.44 and 0.28 for outlet location. The maximum PMV recorded was 0.59. The PMV of eight point was (-0.03,0.13,0.28,0.28,0.44,0.28,0.44,0.59). The PMV distribution at the height of 0.5 m in the indoor open space morning session was identified, the predicted mean vote (PMV) needs a higher air velocity to achieve comfort under 0.5 m height. Based on the PMV contour plot, it noticed that the PMV was slightly exceeded the recommended range identified by ASHRAE-55 which between -0.5 and +0.5. Hence, since the PMV is used for predicting the mean value of subjective rating of group of people in given environment, it is also used to check the compliance of a stated thermal environment with comfort and also use to stablish different level of acceptability requirement based on ASHRAE standard-55.

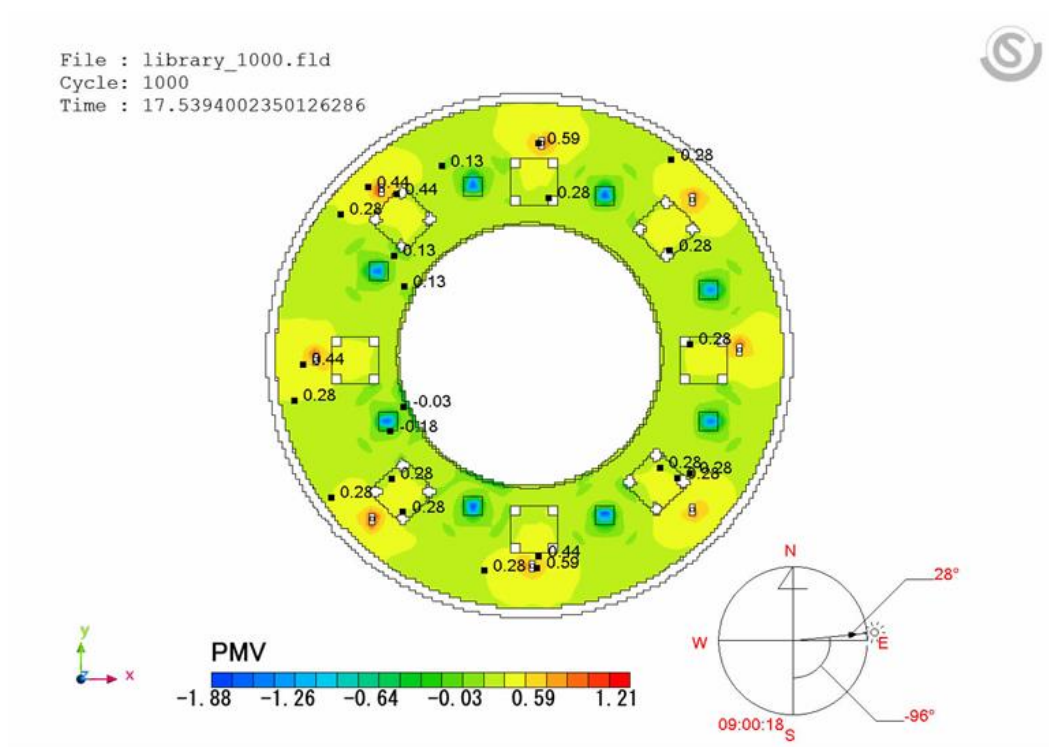

Fig. 7. PMV contour plot day two morning session at 0.5 m height

Figure 8 elaborates the PMV result of day two afternoon session. The selected height defined at 0.5 m with average of indoor open space air temperature of 23.40°C, and relative humidity of 71.42% and mean radiant temperature of 23.75°C. From the contour plot It can be observed that the highest PMV value was 0.75 near the outlet point and the lowest PMV value was -0.49 located straight down the inlet diffuser. The PMV of eight points is ascertain from (-0.49,0.13,0.28,0.59,0.44,0.28,0.44,0.75). Hence, increased of PMV index indicates near the outlet, window glass and walls, that means occupants are feeling warm. Furthermore, the results showed that the PMV went up to 0.75 which was more than what ASHARAE 55 suggested. Therefore, occupants feel slightly uncomfortable at some points. This condition can occur due to the location of some points near the window glass and walls that can generate radiant heat in such areas which make occupants feel warm and slightly uncomfortable.

File : library_1000.fld
Cycle: 1000
Time : 17.5402187719953240

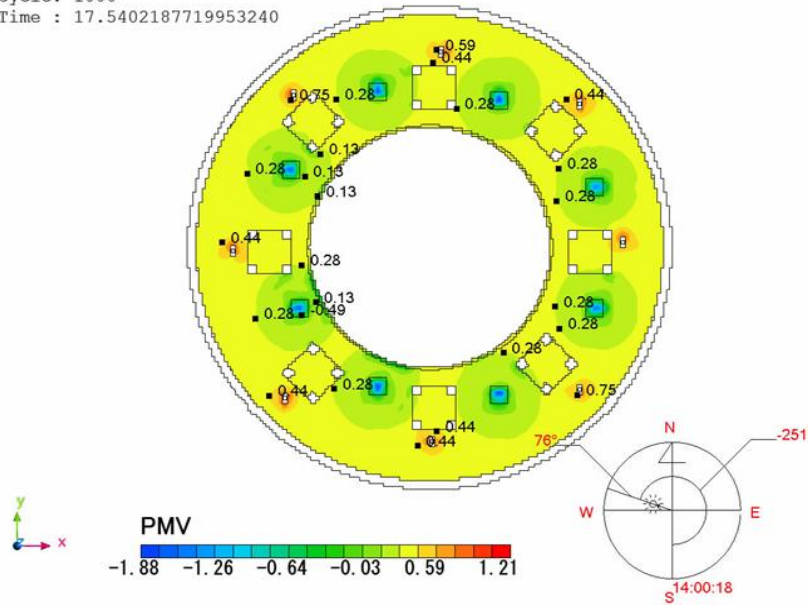

Fig. 8. PMV contour plot of day two afternoon session at 0.5 m height

2.3.6 TSV validation

Figure 9 illustrates the TSV model configuration result of day one morning session at 0.5 m height. The TSV configuration was generated from regression equation from the field measurement conducted. The TSV contour plot was generated from the regression model of PMV and TSV of the field measurement. Based on the contour plot result, occupants expressed their sensation in different categories. The TSV of the eight simulated points was (-0.0,0.2,0.4,0.1,0.3,0.4,0.2,0.4). The TSV at some point for day one was reduced substantially up to -0.0 but the respective limit was within the ASHRAE Standard-55. It showed that occupants felt thermally comfort with their condition. Hence, the obtained values were still within the recommended range of -0.5 and +0.5.

File : library_1000.fld
Cycle: 1000
Time : 17.5403930554867635

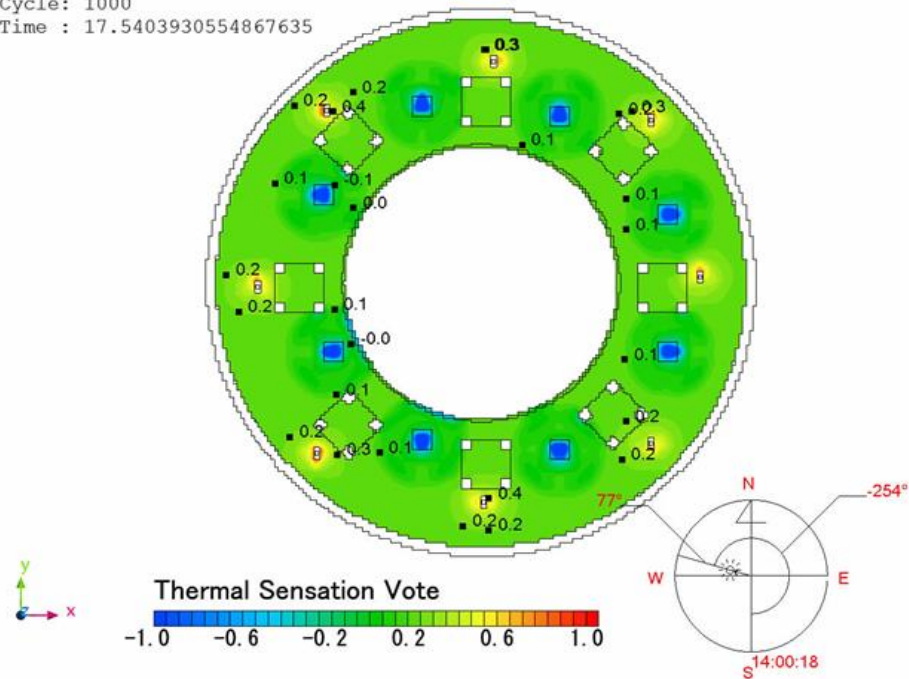

Fig. 9. TSV configuration contour plot for day one morning session at 0.5 m height

Figure 10 elaborate the TSV contour plot of day one afternoon session at 0.5 m. From the eight measured points occupants have different sensation toward their indoor open space environment. Due to slight differences in airflow supplied magnitude. Hence, other occupants' location was close to the window and walls of the indoor open space, the level of their thermal sensation can be different. This can be demonstrated in all the eight selected points of the library. The TSV was ranged from (0.0,0.4,0.3,0.6, 0.3,0.2,0.5,0.4). Thermal sensation will be considered based on their own perceptions of thermal sensation level through a scale. The results show that the TSV was beyond the comfort range specified by the ASHRAE-55Standard-55 which is between -0.5 and +0.5.

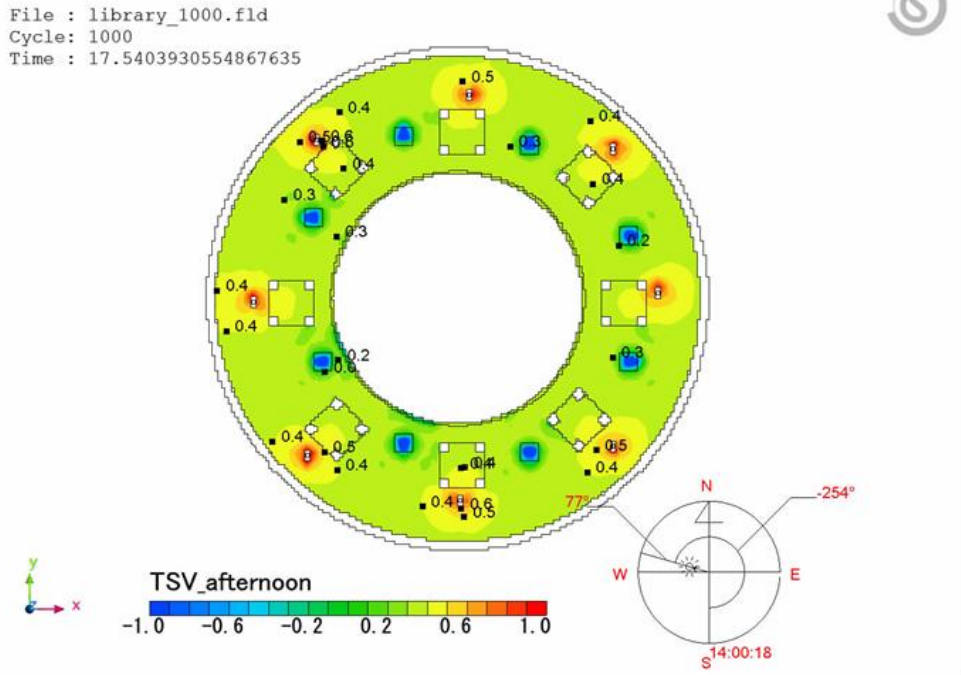

Fig. 10. TSV contour plot result of day one afternoon session at 0.5 m height

Figure 11 describes the TSV day two morning session at 0.5m height. The TSV of the eight-point recorded from (0.0,0.2,0.4,0.1,0.3,0.1,0.4,0.2). It clear evidence is that; occupants reveal their thermal sensation separately. Thus, Occupants who sit nearer to the inlet diffuser are feeling colder compared to those who sit from the outlet locations. It showed that the TSV in the day two morning session the occupants consider their indoor open space thermally comfortable. The TSV configuration plot values was within the recommended range that suggested by ASHARE which is between -0.5 and +0.5

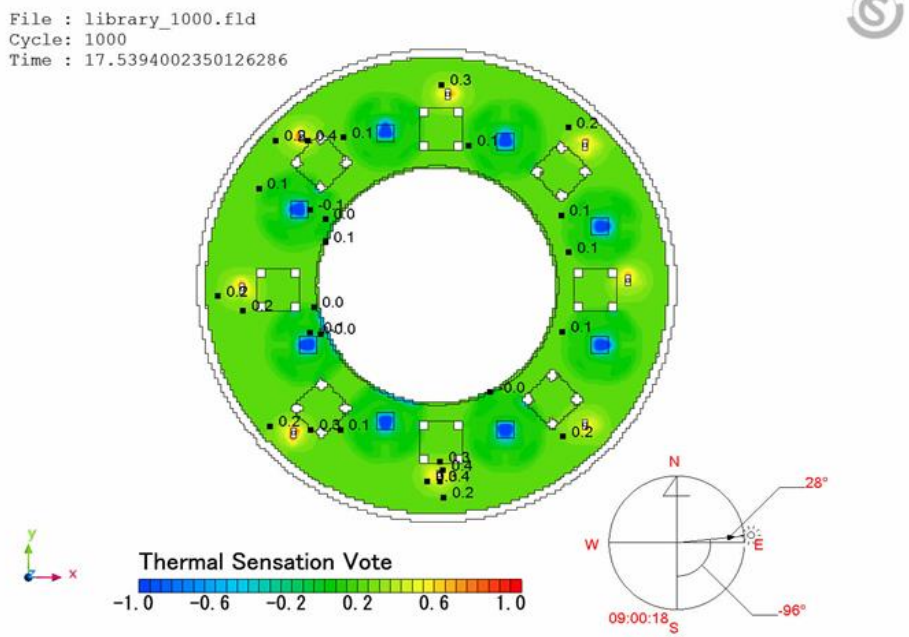

Fig. 11. TSV plot of day two morning session at 0.5 m height

Figure 12 explains the TSV day two afternoon session at 0.5 m height. The TSV ranged from (-0.2,0.5,0.3, 0.6,0.4,0.3,0.6,0.5). It can be observed that occupant experienced slightly cool air as appeared in point one at -0.2. The overall sensation predicted for occupants were categorized as slightly cool, neutral, and slightly warm based on the reading provided by the contour plot. Therefore, based on the contour plot results occupants felt thermally uncomfortable due to some values among the eight points exceeding the range that recommended by ASHRAE 55. Based on the TSV index variation indoor open space occupants in the day two in the afternoon session it is beyond the recommended -0.5 and +0.5. The reason behind this is because the air condition is directly facing downward, and this caused the facing area coolest compare to other region. Therefore, the reasonable comfort temperature distribution must meet the requirement of thermal comfort.

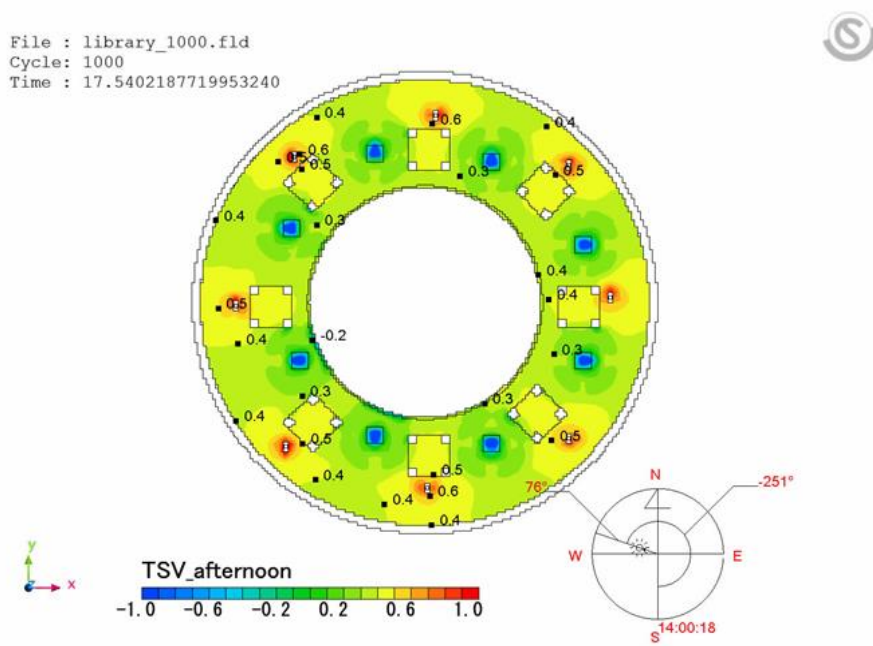

Fig. 12. TSV configuration plot for day to afternoon session at 0.5 m height

Table 6 presents comparison and relative error result between field measurement and simulation of TSV. The data selected was for day one and day two for both session morning and afternoon session. As can be seen from the table, the variation between the actual experimental data and the simulation in each session was low. This minimum dissimilarity can be noticed in the relative error between the experiment and the simulation with less than 5% of relative error, this reading gives indication that the simulation and the experiment in good agreement.

Table 6

TSV comparison based on field measurement and simulation results

Day	Field measurement	Simulation	Relative error
Day 1 (4 April) Morning session	23.81	23.17	2.69%
Day 1 (4 April) Afternoon session	23.45	23.84	1.66%
Day 2 (5 April) Morning session	24.00	23.96	0.17%
Day 2 (5 April) Afternoon session	23.66	23.92	1.10%

3. Determination of Comfort Temperature Range

After validation of the model, there were several points of PMV and TSV model configuration which were beyond the ASHRAE Standard- 55 recommended values. PMV and TSV recommended to

be between -0.5 and +0.5 to get thermal comfort condition the indoor open space. This requires adjusting the PMV and TSV between -0.5 and +0.5. By adjusting some environmental parameters such as air temperature and relative humidity in the CFD model to get the comfort temperature of the indoor open space as clarified in Table 7. Maintaining the PMV and TSV level between -0.5 and +0.5 will be able to offset the increase of comfort temperature range while maintaining the comfort temperature level of the indoor open space in to standardized level [27]. Therefore, the PMV model of 0.5 m height in the eight selected points, for morning session was adjusted at (0.25,0.36,0.43,0.48,0.30,0.28,0.39,0.49) with air temperature of 23.80 °C and relative humidity of 55.0%. Both factors were within the ASHARE 55 standard. This reading indicates that the PMV variables of all eight points of morning session at 0.5 m height was between -0.5 and +0.5. Thus, the PMV model of 0.5 m height for the eight identified points, for afternoon session was adjusted to (-0.45,0.34,0.28,0.39,0.50,0.25,0.33,0.30). The air temperature and relative humidity was adjusted at 24.33°C and 58.7% as recommended by ASHRAE 55. In addition, the PMV for day two at 0.5 m height throughout the eight points for morning session was (0.40,0.30,0.22,0.35,0.39,0.28,0.33,0.41). The air temperature was 24.53°C and relative humidity of 60.0%. The finding indicates that, the PMV was acceptable between -0.5 and +0.5. The PMV contour plot model for day two afternoon session at 0.5 m height for eight selected locations was (0.34,0.18,0.40,0.33,0.48,0.33,0.39,0.47). The PMV of day two afternoon session was within the limit that suggested by ASHARAE -55 same as the two most essential environmental factors affect the comfort temperature range. Furthermore, the TSV of day one morning session, occupants experience different variation of thermal sensation throughout the eight points (-0.3, 0.2,0.4,0.1,0.4,0.2,0.2,0.3), the air temperature was 23.80°C and relative humidity of 55.0%. The TSV recorded precisely as presented in ASHRAE-55. Moreover, the TSV of day one at 0.5 m height for the eight points in the afternoon session was varies from (0.5,0.3,0.2,0.4,0.2,0.3,0.5,0.4), with air temperature of 24.33°C and relative humidity at 58.7%. These recorded conditions can allow occupants to feel more comfort with comfort temperature within the average. Thus, for the TSV for day two morning session. The TSV of the eight point was determined at (0.3,0.2,0.5,0.1,0.4, 0.1,0.2,0.3). The air temperature ranges at 24.53 °C with relative humidity of 60.0 %, apparently, indoor open space occupants experienced acceptable comfort temperature with the TSV range within the proposed variation identified by ASHRAE 55. In addition, the TSV for afternoon session for day two the air temperature was 23.49°C, with relative humidity of 50.0%. Hence, the TSV at 0.5 m height for day two afternoon session at the eight points was identified at (-0.3,0.4,0.2,0.5,0.3,0.2,0.3,0.5). The TSV model shows that occupants felt thermally comfortable with their indoor open space environment. The PMV and TSV for day and day for morning and afternoon session was between -0.5 and +0.5. Therefore, the indoor open space comfort temperature was within the recommended specified by ASHRAE Standard- 55.

Table 7
 Summary of comfort temperature range based on PMV and TSV model

	PMV		TSV	
	Air temp. (°C)	Relative humidity (%)	Air temp. (°C)	Relative humidity (%)
Day 1 (morning)	23.80	55.0	23.80	55.0
Day 1 (afternoon)	24.33	58.7	24.33	58.7
Day 2 (morning)	24.53	60.0	24.53	60.0
Day 2 (afternoon)	23.80	55.0	23.49	50.0
Average	24.12	57.2	24.04	57.2

4. Conclusions

In this study, a CFD model was developed for thermal comfort analysis in open spaces in library buildings. The model validation was conducted by comparing simulation results with field measurement results for day one and day two (morning and afternoon session) measured at 0.5 m height from the floor. The comparison compromised the fundamental environmental parameters, such as air temperature, relative humidity, mean radiant temperature, including the PMV and TSV.

The results of the study showed that the relative errors between simulation and field measurement were less than 5.5% for air temperature, relative humidity, and mean radiant temperature. The relative error for PMV and TSV value between simulation and field measurement were less than 12.2% and 2.7% respectively. The study concluded that the experiment and the simulation value for all parameters investigated were in good agreement with acceptable relative error value.

The validated model was used to analyse the study concluded that the average value of comfort temperature and relative humidity for thermal comfort value of PMV and TSV in the investigated open spaces in the library were 24 °C and 57% respectively.

Also the study concluded that the comfort temperature range based on PMV and TSV model was defined based the ASHRAE Standard- 55. The study shows that, the PMV and TSV was between -0.5 and + 0.5. as recommended by ASHRAE-55. Therefore, the comfort temperature ranges of the indoor open space for first and second days (morning and afternoon session) was within the ASHRAE Standard 55. This study stated the related issues research gap for further studies to achieve a satisfactory indoor thermal condition in the typical library in hot-humid climate. Several suggestions for future research are recommended to refine the detail procedures carried out in this study. The impact of the indoor thermal conditions on the performance and productivity of the occupant. Also the study recommended that future research incorporates the impact of the materials, equipment's and machines within the library on the spaces thermal conditions of the occupants.

Acknowledgement

This research was funded by the Ministry of Higher Education (MOHE) of Malaysia through Fundamental Research Grant Scheme (FRGS/1/2020/WAB02/UTHM/02/7). The authors acknowledged the support of the Industrial Hygiene (IH) Research Group, Faculty of Mechanical and Manufacturing Engineering (FKMP), Universiti Tun Hussein Onn Malaysia.

References

- [1] Ismail, Ahmad Rasdan, Norfadzilah Jusoh, Nor Kamaliana Khamis, Raemy Md Zein, and Nurul Husna Che Hassan. "CFD Study on Thermal Implication towards Human Body in Office Environment." *Journal of Advanced Research in Fluid Mechanics and Thermal Sciences* 85, no. 1 (2021): 125-134. <https://doi.org/10.37934/arfmts.85.1.125134>
- [2] Ismail, Firas Basim, Nizar FO Al-Muhsen, and Ain Amira Johari. "Thermal Comfort Analysis for Overhead and Underfloor Air Distribution Systems." *CFD Letters* 13, no. 12 (2021): 113-132. <https://doi.org/10.37934/cfdl.13.12.113132>
- [3] Wong, Keng Yinn, Mohamed Kamar Haslinda, Kamsah Nazri, and Sofia Norazam Alia. "Effects of surgical staff turning motion on airflow distribution inside a hospital operating room." (2019): 52-58. <https://doi.org/10.5109/2321008>
- [4] Pal, Dulal, and Hiranmoy Mondal. "Influence of temperature-dependent viscosity and thermal radiation on MHD forced convection over a non-isothermal wedge." *Applied Mathematics and Computation* 212, no. 1 (2009): 194-208. <https://doi.org/10.1016/j.amc.2009.02.013>
- [5] Fohimi, Nor Azirah Mohd, Muhammad Hanif Asror, Rosniza Rabilah, Mohd Mahadzir Mohammad, Mohd Fauzi Ismail, and Farid Nasir Ani. "CFD Simulation on Ventilation of an Indoor Atrium Space." *CFD Letters* 12, no. 5 (2020): 52-59. <https://doi.org/10.37934/cfdl.12.5.5259>

- [6] Sidik, Nor Azwadi Che, Tung Hao Kean, Hoong Kee Chow, Aravinthan Rajaandra, Saidur Rahman, and Jesbains Kaur. "Performance enhancement of cold thermal energy storage system using nanofluid phase change materials: a review." *International Communications in Heat and Mass Transfer* 94 (2018): 85-95. <https://doi.org/10.1016/j.icheatmasstransfer.2018.03.024>
- [7] Calautit, John Kaiser, Dominic O'Connor, Polytimi Sofotasiou, and Ben Richard Hughes. "CFD simulation and optimisation of a low energy ventilation and cooling system." *Computation* 3, no. 2 (2014): 128-149. <https://doi.org/10.3390/computation3020128>
- [8] Yüksel, Ahmet, Müslüm Arıcı, Michal Krajčík, Mihriban Civan, and Hasan Karabay. "A review on thermal comfort, indoor air quality and energy consumption in temples." *Journal of Building Engineering* 35 (2021): 102013. <https://doi.org/10.1016/j.jobbe.2020.102013>
- [9] Fahmy, M., M. Morsy, H. Abd Elshakour, and A. M. Belal. "Effect of thermal insulation on building thermal comfort and energy consumption in Egypt." *Journal of Advanced Research in Applied Mechanics* 43, no. 1 (2018): 8-19.
- [10] Wong, N. H., J. Song, and A. D. Istiadji. "A study of the effectiveness of mechanical ventilation systems of a hawker center in Singapore using CFD simulations." *Building and Environment* 41, no. 6 (2006): 726-733. <https://doi.org/10.1016/j.buildenv.2005.03.015>
- [11] Halim, Nur Fazlin Che, and Nor Azwadi Che Sidik. "Nanorefrigerants: A Review on Thermophysical Properties and Their Heat Transfer Performance." *Journal of Advanced Research in Applied Sciences and Engineering Technology* 20, no. 1 (2020): 42-50. <https://doi.org/10.37934/araset.20.1.4250>
- [12] Ismail, Mohd Azmi, and Mohd Sabri Che Jamil. "CFD HVAC study of modular badminton hall." *CFD Letters* 12, no. 7 (2020): 90-99. <https://doi.org/10.37934/cfdl.12.7.9099>
- [13] Handbook, A. S. H. R. A. E. "American Society of Heating." *Refrigerating and Air Conditioning Engineers, Atlanta* (2005).
- [14] Azizpour, Fatemeh, Saeid Moghimi, Chinhaw Lim, Sohif Mat, Azami Zaharim, and Kamaruzzaman Sopian. "Thermal comfort assessment in large scale hospital: Case study in Malaysia." In *Proceedings of the 4th WSEAS international conference on Energy and development-environment-biomedicine*, pp. 171-174. 2011.
- [15] Djabir, Djabir Abdoulaye, Azian Hariri, Mohamad Nur Hidayat Mat, and Md Hasanuzzaman. "Thermal Comfort of Indoor Open Spaces at University Library in Malaysia." *Journal of Advanced Research in Fluid Mechanics and Thermal Sciences* 94, no. 2 (2022): 142-165. <https://doi.org/10.37934/arfmts.94.2.142165>
- [16] Hatif, Ihab Hasan, Azian Hariri, and Ahmad Fu'ad Idris. "CFD analysis on effect of air Inlet and outlet location on air distribution and thermal comfort in small office." *CFD Letters* 12, no. 3 (2020): 66-77. <https://doi.org/10.37934/cfdl.12.3.6677>
- [17] Wijaya, Elang Pramudya, and Ardiyansyah Saad Yatim. "Numerical investigation of air movement on laboratory scale psychrometric chamber." *Journal of Advanced Research in Fluid Mechanics and Thermal Sciences* 84, no. 2 (2021): 82-91. <https://doi.org/10.37934/arfmts.84.2.8291>
- [18] Hafez, Ahmed Hussein, Tamer Heshmat Mohamed Aly Kasem, Basman Elhadidi, and Mohamed Madbouly Abdelrahman. "Modelling Three Dimensional Unsteady Turbulent HVAC Induced Flow." *Journal of Advanced Research in Fluid Mechanics and Thermal Sciences* 87, no. 1 (2021): 76-90. <https://doi.org/10.37934/arfmts.87.1.7690>
- [19] Nicol, J. Fergus, and Michael A. Humphreys. "Adaptive thermal comfort and sustainable thermal standards for buildings." *Energy and buildings* 34, no. 6 (2002): 563-572. [https://doi.org/10.1016/S0378-7788\(02\)00006-3](https://doi.org/10.1016/S0378-7788(02)00006-3)
- [20] McPherson, E. Gregory, Lee P. Herrington, and Gordon M. Heisler. "Impacts of vegetation on residential heating and cooling." *Energy and Buildings* 12, no. 1 (1988): 41-51. [https://doi.org/10.1016/0378-7788\(88\)90054-0](https://doi.org/10.1016/0378-7788(88)90054-0)
- [21] Launder, Brian Edward, and Bahrat I. Sharma. "Application of the energy-dissipation model of turbulence to the calculation of flow near a spinning disc." *Letters in heat and mass transfer* 1, no. 2 (1974): 131-137. [https://doi.org/10.1016/0094-4548\(74\)90150-7](https://doi.org/10.1016/0094-4548(74)90150-7)
- [22] Fekadu, Birlie, and H. V. Harish. "Numerical Studies on Thermo-Hydraulic Characteristics of Turbulent Flow in a Tube with a Regularly Spaced Dimple on Twisted Tape." *CFD Letters* 13, no. 8 (2021): 20-31. <https://doi.org/10.37934/cfdl.13.8.2031>
- [23] Nada, S. A., H. M. El-Batsh, H. F. Elattar, and N. M. Ali. "CFD investigation of airflow pattern, temperature distribution and thermal comfort of UFAD system for theater buildings applications." *Journal of Building Engineering* 6 (2016): 274-300. <https://doi.org/10.1016/j.jobbe.2016.04.008>
- [24] Hoang, Hong-Minh, Steven Duret, Denis Flick, and Onrawee Laguerre. "Preliminary study of airflow and heat transfer in a cold room filled with apple pallets: Comparison between two modelling approaches and experimental results." *Applied Thermal Engineering* 76 (2015): 367-381. <https://doi.org/10.1016/j.applthermaleng.2014.11.012>
- [25] Widiastuti, Ratih, Juliana Zaini, Mochamad Agung Wibowo, and Wahyu Caesarendra. "Indoor thermal performance analysis of vegetated wall based on CFD simulation." *CFD Letters* 12, no. 5 (2020): 82-90. <https://doi.org/10.37934/cfdl.12.5.8290>

- [26] Muhieldeen, M. W., and Y. C. Kuang. "Saving energy costs by combining air-conditioning and aircirculation using CFD to achieve thermal comfort in the building." *Journal of Advanced Research in Fluid Mechanics and Thermal Sciences* 58, no. 1 (2019): 84-99.
- [27] Alawi, Omer A., and Nor Azwadi Che Sidik. "Mathematical correlations on factors affecting the thermal conductivity and dynamic viscosity of nanorefrigerants." *International Communications in Heat and Mass Transfer* 58 (2014): 125-131. <https://doi.org/10.1016/j.icheatmasstransfer.2014.08.033>